

# PXC 550-II

Around-ear headphones

Model: SEBT5



**Instruction manual**

Use the search function, the navigation (left) or the following links:

Start

“Product overview”

“Getting started”

“Using the headphones”

“FAQ/If a problem occurs ...”

“Specifications”



Sennheiser electronic GmbH & Co. KG

Am Labor 1

30900 Wedemark

Germany

[www.sennheiser.com](http://www.sennheiser.com)



Version: 03/20 A03

## Important safety instructions



- ▷ Read this instruction manual carefully and completely before using the product.
- ▷ Always include this instruction manual when passing the product on to third parties.
- ▷ Do not use the product if it is obviously defective or makes loud, unusual (whistling or beeping) noise.
- ▷ Only use the product in environments where Bluetooth® wireless transmission is permitted.

### Preventing damage to health and accidents

- ▷ Protect your hearing from high volume levels. Permanent hearing damage may occur when headphones are used at high volume levels for long periods of time. Sennheiser headphones sound exceptionally good at low and medium volume levels. 
- ▷ The product generates stronger permanent magnetic fields that could cause interference with cardiac pacemakers, implanted defibrillators (ICDs) and other implants. Always maintain a distance of at least 3.94"/10 cm between the product component containing the magnet and the cardiac pacemaker, implanted defibrillator, or other implant. 
- ▷ Keep the product, accessories and packaging parts out of reach of children and pets to prevent accidents. Swallowing and choking hazard.
- ▷ Do not use the product in an environment that requires your special attention (e.g. in traffic or when performing skilled jobs). Especially the product's active noise cancellation can make ambient noise inaudible or drastically change the perception of acoustic warning signals.

### Preventing damage to the product and malfunctions

- ▷ Always keep the product dry and do not expose it to extreme temperatures (hairdryer, heater, extended exposure to sunlight, etc.) to avoid corrosion or deformation. The normal operating temperature is from 0 to 40 °C/32 to 104 °F.
- ▷ To avoid loud, unusual (whistling or beeping) noise and to ensure proper noise cancellation, do not cover the microphone openings of the active noise cancellation circuitry located on the outside of the ear cups.
- ▷ Use only attachments/accessories/spare parts supplied or recommended by Sennheiser.
- ▷ Clean the product only with a soft, dry cloth.
- ▷ Use the product with care and store it in a clean, dust-free environment.

Safety instructions for the lithium polymer rechargeable battery



**WARNING**

If abused or misused, the rechargeable batteries may leak. In extreme cases, they may even present a risk of:

- heat generation,
- fire development,
- explosion,
- smoke or gas development.

	<p>Only use rechargeable batteries and chargers recommended by Sennheiser.</p>
	<p>Only charge the product / rechargeable batteries at ambient temperatures between +10 °C to +40 °C/50 °F to 104 °F.</p>
	<p>Do not heat the product / rechargeable batteries above +70 °C/140 °F. Avoid exposure to sunlight and do not throw the product / rechargeable batteries into fire.</p>
	<p>When not using the product / rechargeable batteries for extended periods of time, charge them regularly (about every three months).</p>
	<p>Switch rechargeable battery-powered products off after use.</p>
	<p>Dispose of defective products with built-in rechargeable batteries at special collection points or return them to your specialist dealer.</p>

Notes on data collection and processing and on firmware updates

This product stores individual settings such as the volume and the Bluetooth addresses of paired devices. This data is required for the operation of the product and is not transferred to Sennheiser or companies commissioned by Sennheiser and is not processed.

Using the “Sennheiser Smart Control” app, you can update the firmware of the product for free via an Internet connection. If the device on which the app is installed is connected to the Internet, the following data is automatically transferred to and processed by Sennheiser servers in order to provide and transfer suitable firmware updates: hardware identifier, hardware revision number, firmware version of the product, operating system type (Android, iOS) and version, version of the app. The data will only be used as specified and will not be stored permanently. If you do not want this data to be transferred and processed, do not connect to the Internet.

Intended use/Liability

These headphones have been designed as an accessory for Bluetooth compliant devices. They are intended for wireless audio communication such as music playback and phone calls via Bluetooth wireless technology.

It is considered improper use when the product is used for any application not named in the corresponding product documentation.

## Important safety instructions

Sennheiser does not accept liability for damage arising from misuse or improper use of this product and its attachments/accessories.

Sennheiser is not liable for damages to USB devices that are not consistent with the USB specifications.

Sennheiser is not liable for damages resulting from the loss of connection due to flat or overaged rechargeable batteries or exceeding the Bluetooth transmission range.

Before putting into operation, please observe the respective country-specific regulations.

## Package contents



PXC 550-II around-ear headphones  
Model: SEBT5

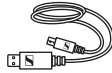

USB cable with micro-USB connector,  
length approx. 1.2 m



Analog audio cable with 2.5 mm jack plug and 3.5 mm  
jack plug,  
length approx. 1.4 m



In-flight adapter

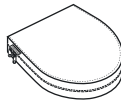

Carry case



Quick guide



Safety guide



Online you can find:

- this detailed instruction manual and additional information [www.sennheiser.com/download](http://www.sennheiser.com/download)
- the Sennheiser Smart Control app for configuring the headphones and for additional functions [www.sennheiser.com/smart-control](http://www.sennheiser.com/smart-control)



A list of accessories can be found on the PXC 550-II product page at [www.sennheiser.com](http://www.sennheiser.com). Contact your local Sennheiser partner: [www.sennheiser.com](http://www.sennheiser.com) > “Service & Support”.

# Product overview

## PXC 550-II

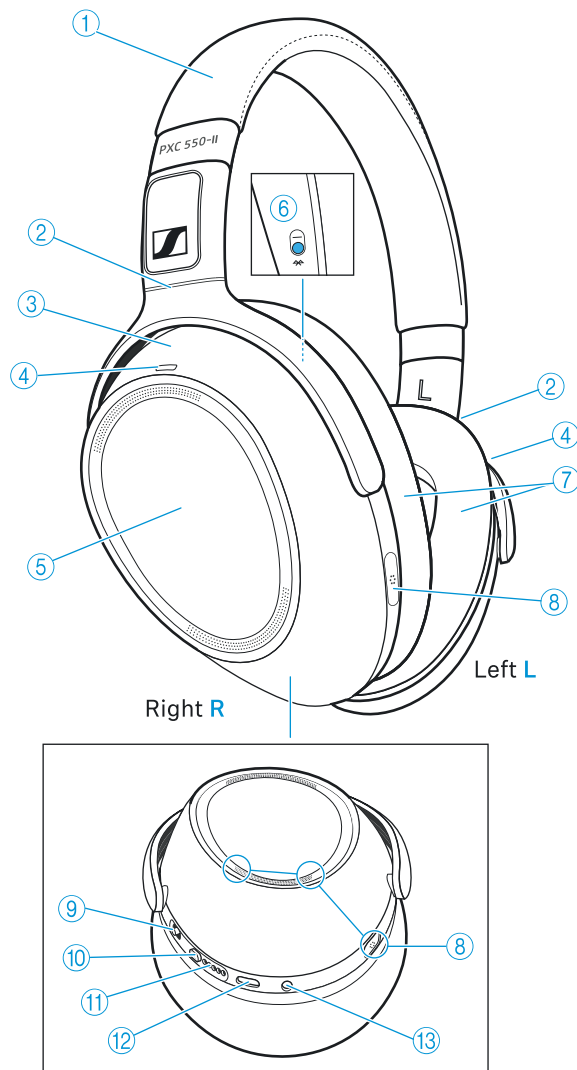







- ① Headband
- ② Ear cup joint with on/off function for the headphones
- ③ Ear cups, steplessly adjustable
- ④ Microphones for active noise cancellation ANC:  
2x directed outward, 2x directed inward (not visible)
- ⑤ Touch pad (right ear cup)
- ⑥ Bluetooth on/off switch  
position: off "0", on "I"
- ⑦ Ear pads
- ⑧ Speech microphones (3x) for phone calls

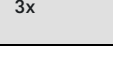

- ⑨ Active noise cancellation (ANC) switch  
position: off “0”, USER mode “1”, MAX mode “II”
- ⑩ Voice assistant button   
pressing for 4 seconds activates the Bluetooth pairing mode
- ⑪ LED
- ⑫ Input for USB micro-B;  
for charging and music playback/data connection
- ⑬ Input for analog audio cable;  
when a cable is connected, flight mode is activated/Bluetooth is deactivated

### Overview of the LED display





#### During operation



LED		Meaning; the headphones...
 3x	flashes white 3x	... switch on
 3x	flashes white 3x	... are connected to a device via Bluetooth
 3x	flashes red 3x	... switch off
 3x	flashes red 3x	... are not connected to a device via Bluetooth or the connection has been lost
	flashes white sequentially	... are in Bluetooth pairing mode
 3x	flashes red	A charging error/battery error has occurred (> 33)

#### During phone calls

LED		Meaning
 3x	flashes white 3x	Incoming call
 3x	flashes red 3x	Incoming call and the rechargeable battery of the headphones is almost empty

#### During charging

LED		Meaning
	1 red	Rechargeable battery is almost empty (less than 2% charged)
	1 white	Battery is approx. 2-20% charged
	2 white	Battery is approx. 20-40% charged
	3 white	Battery is approx. 40-60% charged

LED		Meaning
	4 white	Battery is approx. 60-80% charged
	5 white	Battery is more than 80% charged



If the LED display does not light up immediately during charging, clean the charging contacts and charge the headphones until the LED display lights up again (> 12).

### Notes on voice prompts

The headphones output voice prompts for various functions (see examples below). Using the Smart Control app, you can change the language of the voice prompts, choose between voice prompts and beep sounds, or deactivate the status messages with a few exceptions (e.g. rechargeable battery is empty).



Voice prompt	Meaning/headphones
“Power on”	switched on
“Power off”	switched off
“Device (1) (2) connected”	are connected to device 1 or 2
“No connection”	not connected via Bluetooth
“Pairing”	are in Bluetooth pairing mode
“Pairing successful”	Bluetooth pairing successful
“No device found”	cannot connect to a paired device
“Volume min”	volume set to minimum
“Volume max”	volume set to maximum
“Call rejected”	incoming call rejected
“Call ended”	call ended
“Mute on”	Microphone is muted, active call is put on hold
“Mute off”	Microphone is reactivated
“More than xx % battery left”	Rechargeable battery has the stated charge level
“Recharge headset”	Rechargeable battery is empty. Recharge the headphones.



## Overview of the buttons and switches

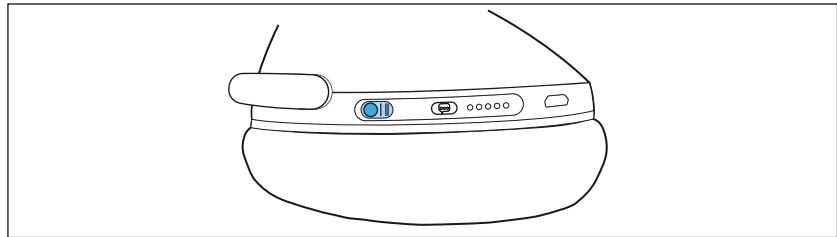

### ANC switch



Position	Function	See
	ANC is deactivated	> 21
	ANC is activated USER mode (can be adjusted via the Smart Control app)	
	ANC is activated MAX mode	

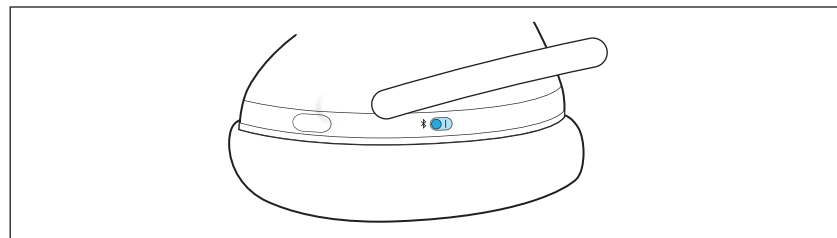

### Bluetooth on/off switch

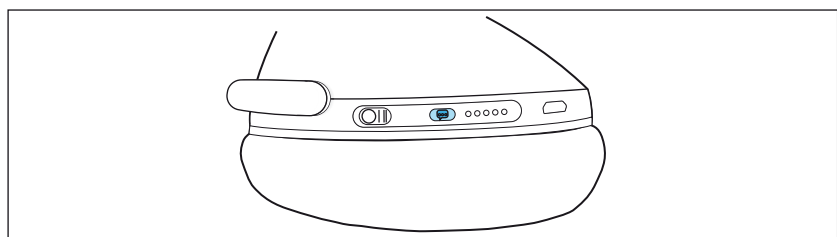

Position	Function	See
	Bluetooth is activated	> 31
	Bluetooth is deactivated	

### Voice assistant button



Press the button	Function	See
 1x	Activates/deactivates the voice assistant	> 27
 4s	Activates the Bluetooth pairing mode	> 15

## Overview of the smart control

### Basic control

Switch-on



Switch-off

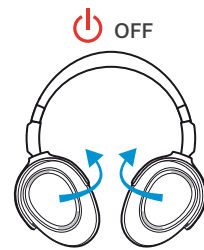

### Gesture control via the touch pad

Briefly tap the touch pad once



Briefly tap the touch pad twice



Tap the touch pad and hold for 2 seconds



Tap the touch pad and hold for 3 seconds

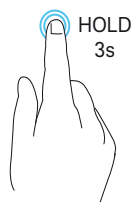

Vertical swipe



Horizontal swipe



Vertical swipe and hold

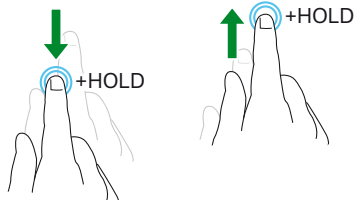

Horizontal swipe and hold

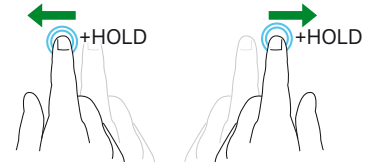

# Getting started

## 1. Charging the rechargeable battery

The headphones' rechargeable battery is not fully charged upon delivery. Before using the headphones for the first time, charge the rechargeable battery for a complete charging cycle without interruption (> 12).

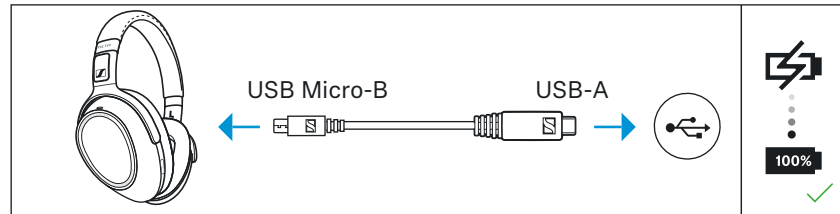

## 2. Installing the Smart Control app on your smartphone

The Sennheiser Smart Control app allows you to use all functions and settings of the headphones and to e.g. adjust the sound to your liking using the equalizer (> 16).



## 3. Connecting the headphones to a Bluetooth device

Connect the headphones to your smartphone via Bluetooth (> 13).

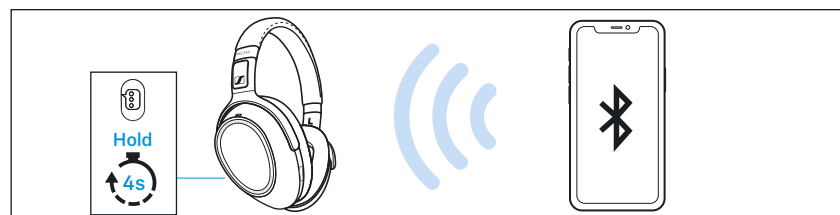

## 4. Putting the headphones on and adjusting the headband

For good sound quality and best possible wearing comfort, the headband can be adjusted to properly fit your head (> 18).

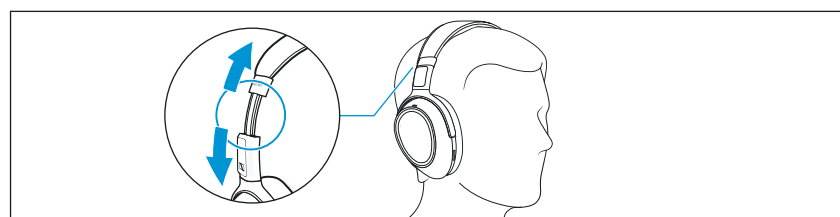

## Using the headphones

### Information on the rechargeable battery and the charging process

The headphones have a built-in rechargeable battery. A complete charging cycle takes approx. 3 hours. The headphones provide 1.5 hours of playback time with a charging time of approx. 10 minutes. Before using the headphones for the first time, charge the rechargeable battery for a complete charging cycle without interruption.

When the headphones are being charged, the LED display lights up (> 7). When the battery charge drops to a critical level, a voice prompt asks you to recharge the headphones (“Recharge headset”).

Sennheiser recommends using the supplied USB cable and a compatible standard USB power supply for charging the headphones.





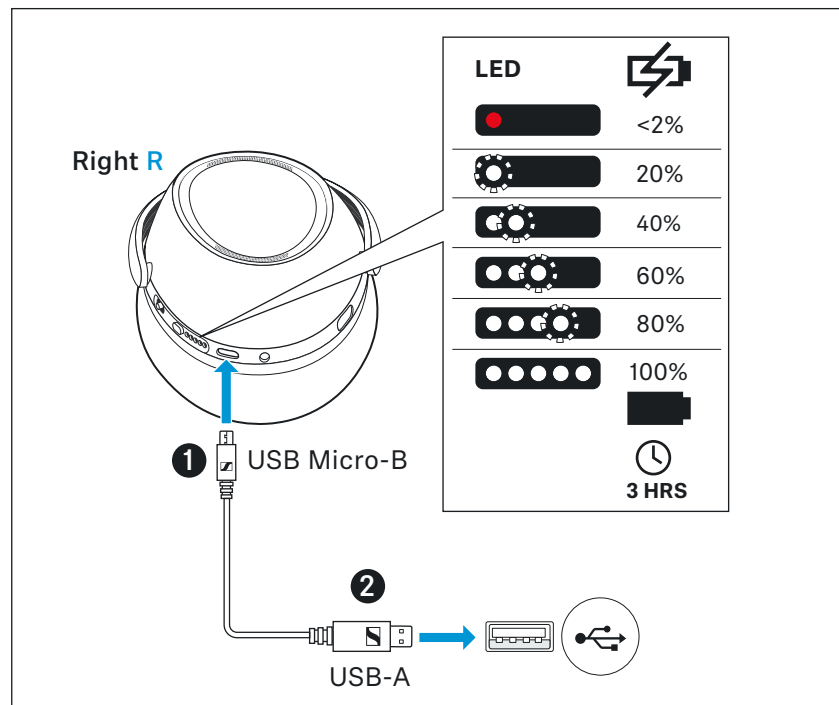

While the headphones are being charged, you can still listen to music or make phone calls. In this case, however, the charging time may be longer.

### Charging the headphones' rechargeable battery



1. Connect the micro USB connector of the charging cable to the micro USB socket of the headphones.
2. Connect the other USB connector of the charging cable to a corresponding socket of a USB power source (\* to be ordered separately). Make sure that the USB power source is connected to the power supply system.

The charging process of the headphones begins. The LED display indicates the charge status:

LED		Meaning
	1 red	Rechargeable battery is almost empty (less than 2% charged)
	1 white	Battery is approx. 2-20% charged
	2 white	Battery is approx. 20-40% charged
	3 white	Battery is approx. 40-60% charged
	4 white	Battery is approx. 60-80% charged
	5 white	Battery is more than 80% charged

**i** If the LED display does not light up immediately during charging, clean the charging contacts and charge the headphones until the LED display lights up again (> 12).

**i** You can speed up the charging process by charging the headphones when they are switched off. For more information on listening to music using the USB cable, > 30.

## Connecting the headphones to a Bluetooth device

To be able to use the Bluetooth connection, you must register both devices (headphones and e.g. smartphone) once. This process is called pairing.

If operation differs from the steps mentioned, also refer to the instruction manual of the Bluetooth device you are using.

**i** When you switch on the headphones for the first time, they automatically switch to pairing mode.

## Information on the Bluetooth wireless connection

The headphones are compatible with Bluetooth 5.0.

If your audio source supports one of the following high-resolution audio encoding methods, music is automatically played in high audio quality: aptX, aptX LL or AAC. Otherwise the headphones will play your music in normal audio quality (SBC).

Paired devices establish the Bluetooth wireless connection immediately after switch-on and are ready for use.

On switch-on, the headphones automatically try to connect to the last two connected Bluetooth devices. The headphones can save the connection profiles of up to eight Bluetooth devices with which they have been paired.

## Using the headphones

If you pair the headphones with the ninth Bluetooth device, the saved connection profile of the least used Bluetooth device will be overwritten. If you want to re-establish a connection with the overwritten Bluetooth device, you have to pair the headphones again.

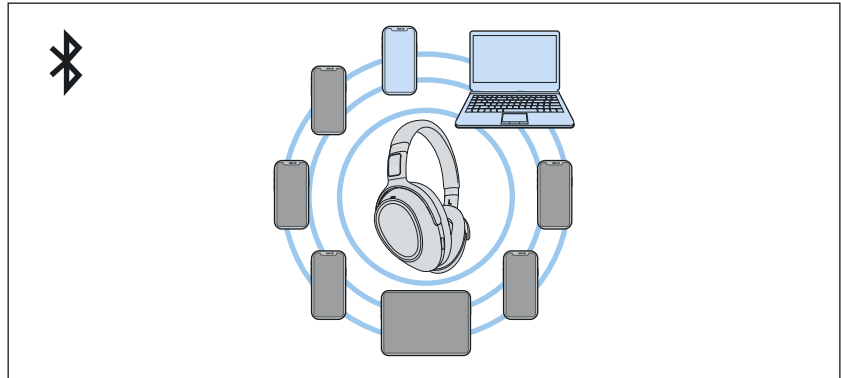

Paired and connected Bluetooth device



Paired Bluetooth device (currently not connected)

## Pairing the headphones with a Bluetooth device

1. Switch the headphones on (> 17) and place them close to the Bluetooth device (max. 20 cm).
2. Press and hold the voice assistant button for 4 seconds until you hear the voice prompt "Pairing".  
The LEDs flash white one after the other. The headphones are in pairing mode.
3. Activate Bluetooth on your Bluetooth device.
4. Via the menu of your Bluetooth device, start the search for new Bluetooth devices.  
All active Bluetooth devices in the proximity of your Bluetooth device are displayed.
5. From the list of found Bluetooth devices, select "PXC 550-II". If necessary, enter the default pin code "0000".  
If pairing was successful, you hear the voice prompts "Pairing successful" and "Device (1) connected". The LED flashes white 3 times.

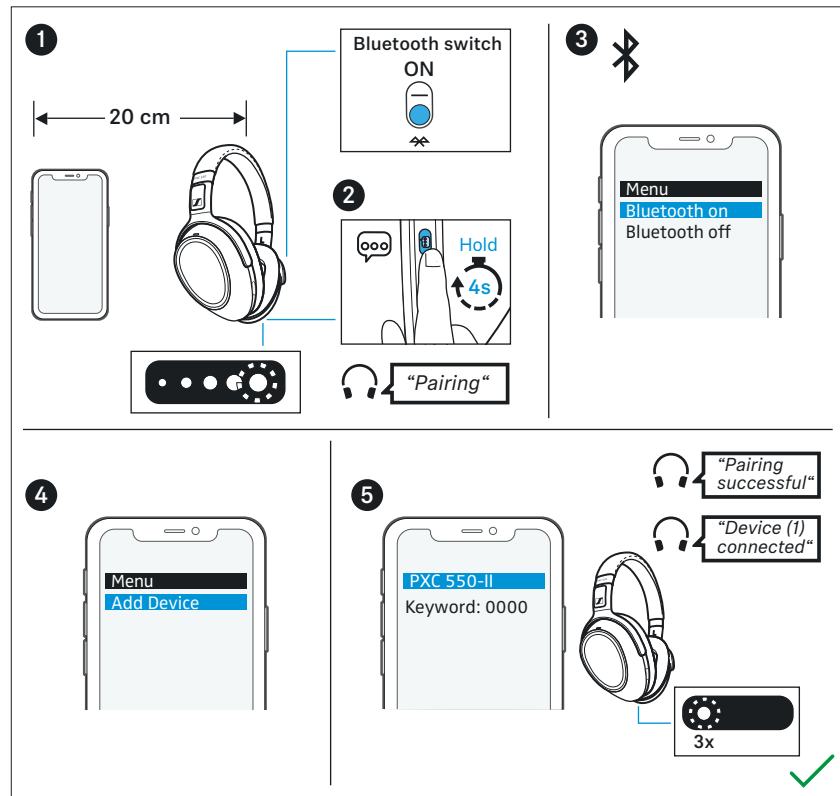

**i** If no connection is established within 5 minutes, pairing mode is terminated and the headphones switch to standby mode. If necessary, repeat the steps described above.

**i** If you switch on the headphones for the first time (the pairing list is empty), they automatically switch to pairing mode.

## Disconnecting the headphones from a Bluetooth device

- ▷ Via the menu of your Bluetooth device, disconnect the connection to the headphones.  
The headphones are disconnected from the Bluetooth device. You hear the voice prompt “Device (1) disconnected”. The headphones switch to standby mode.

**i** To delete the Bluetooth pairing list of the headphones, > 34.

## Installing the Smart Control app

To make full use of all the settings and functions of the headphones, you need to have the free Sennheiser Smart Control app installed on your smartphone.

Download the app from the App Store or Google Play and install it on your smartphone. Alternatively, you can use your smartphone to scan the following QR code or to call up the following Internet site: [www.sennheiser.com/smartcontrol](http://www.sennheiser.com/smartcontrol)



- ▷ Connect your smartphone to the headphones via Bluetooth (> 13).
- ▷ Start the Smart Control app.  
The Smart Control app recognizes the headphones and activates all available settings and functions.

**i** For further functions of the headphones, you require the apps of the respective manufacturers:

- Amazon Alexa app (> 27)



## Switching the headphones on



### WARNING

**Danger of hearing damage due to high volume levels!**

Listening at high volume levels can lead to permanent hearing defects.

- ▷ Before putting the headphones on, adjust the volume to a low level (> 20).
- ▷ Do not continuously expose yourself to high volume levels.

1. Unfold the headphones.
2. Turn the ear cups outward until you hear a click in both ear cup joints.

The LED flashes white 3 times. If Bluetooth is activated on the headphones, you hear the voice prompts “Power on” and “Device (1) connected”.

If Bluetooth is deactivated on the headphones, you hear the voice prompt “Power on”. If necessary, connect the USB cable or the audio cable to the headphones.

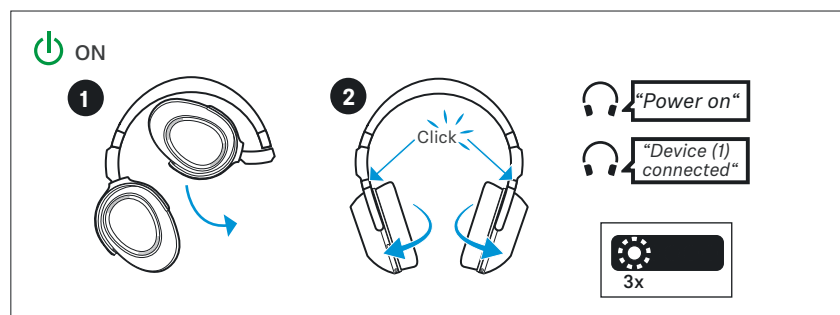

**i** Make sure that Bluetooth is already activated on your Bluetooth device when switching on the headphones.

**i** If Bluetooth is activated and the headphones cannot find a paired Bluetooth device within a few minutes, you hear the voice prompt “No device found”. The first LED of the LED display flashes red. The headphones switch to standby mode.

## Switching the headphones off

1. Hold the headphones so that the left hand holds the right ear cup and the right hand holds the left ear cup. Turn the ear cups inward until you hear a click in both ear cup joints and the touch pad faces toward you.
2. You hear the voice prompt “Power off” and the LED display flashes red 3 times. The headphones switch off.

**i** The red dot displayed on the hinge of the right ear cup also indicates that the headphones are switched off.

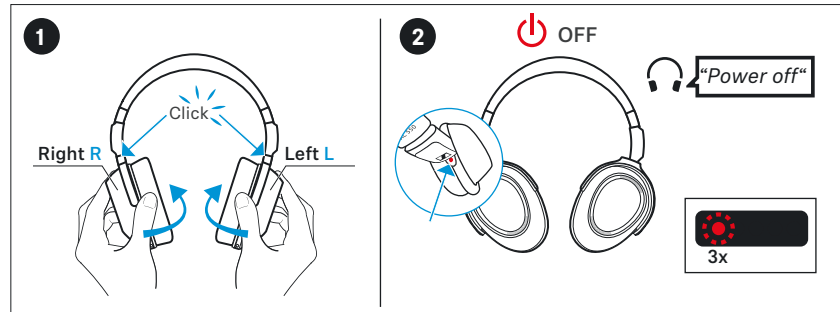

## Putting the headphones on and adjusting the headband

For good sound quality and best possible wearing comfort, the headband can be adjusted to properly fit your head.

- ▷ Wear the headphones so that the headband runs over the top of your head. The markings **R** for the right side and **L** for the left side can be found on the inside of the ear cup joints.
- ▷ Move the ear cups up and down the headband slider until:
  - your ears are comfortably covered by the ear pads,
  - you feel even, gentle pressure around your ears,
  - a snug fit of the headband on the head is ensured.

For optimal sound quality and active noise cancellation ANC, the ear pads must completely surround your ears.

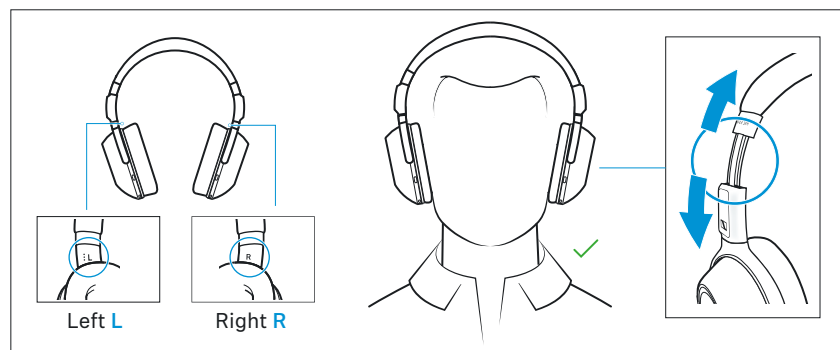

## Retrieving information on the battery charge status

When the headphones are connected to your Bluetooth device, the battery charge status can be displayed on the screen of your smartphone (depending on the device and operating system used).

The Smart Control app also displays the battery charge status.

On the headphones, you can check the battery charge status via the voice prompts (not possible when listening to music or on a call):

- ▷ Tap the touch pad and hold for approx. 4 sec.  
You hear beep sounds and a voice prompt informing you of the remaining battery life. Depending on the battery life of the headphones, the LEDs flash or light up.

Voice prompt	Meaning
"Recharge headset"	The rechargeable battery is empty. Recharge the rechargeable battery (> 12). In addition, the LED display flashes red.
"More than xx % battery left"	The remaining battery charge is displayed as a percentage.

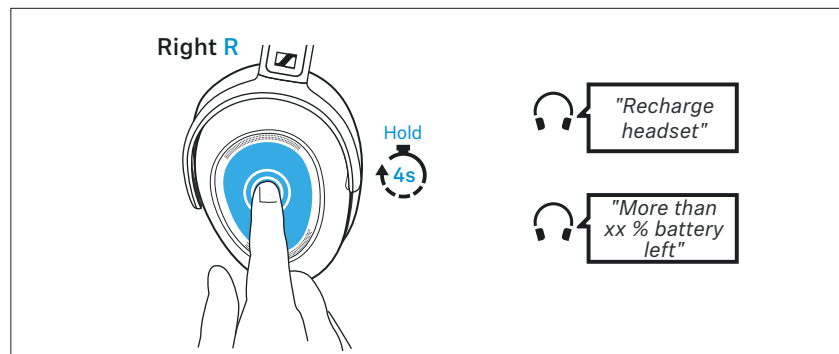

LED	Meaning
1 red	Rechargeable battery is almost empty (less than 2% charged)
1 white	Battery is approx. 2-20% charged
2 white	Battery is approx. 20-40% charged
3 white	Battery is approx. 40-60% charged
4 white	Battery is approx. 60-80% charged
5 white	Battery is more than 80% charged

## Adjusting the volume



### WARNING

#### Danger of hearing damage due to high volume levels!

Listening at high volume levels can lead to permanent hearing defects. Toggling between the audio sources may cause enormous volume jumps that can permanently damage your hearing.

- ▷ Before putting the headphones on and before toggling between audio sources, adjust the volume to a low level.
- ▷ Do not continuously expose yourself to high volume levels.

You can adjust the volume for music, voice prompts, beep sounds, and phone calls.

- ▷ If you are playing music or are on a call: Swipe vertically up or down on the touch pad to increase or reduce the volume for music and phone calls.
- ▷ If the headphones are in idle mode, i.e. you are not playing music or on a call: Swipe vertically up or down on the touch pad to increase or reduce the volume for voice prompts and beep sounds.

When the minimum or maximum volume is reached, you hear the voice prompt “Volume max” or “Volume min”.

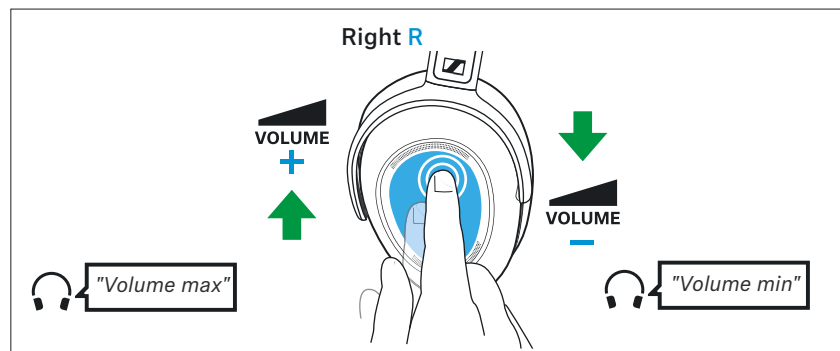

Depending on the length of the swipe motion, you adjust the volume in smaller increments (short swipe motion) or larger increments (long swipe motion).

When switching the headphones off, very high volume levels are automatically reset to a moderate level to protect your hearing when you switch the headphones on again.



You can also adjust the volume using the connected Bluetooth device.

## Information on active noise cancellation ANC

Due to its closed design, the headphones offer effective passive isolation from ambient noise.

In addition, the headphones have an active noise cancellation (ANC) function, which allows you to reduce ambient noise to a minimum.

Even when ANC is activated, your headphones' sound quality is always at its best.

You can activate or deactivate ANC when the headphones and your audio source are connected via Bluetooth, the USB cable, or the audio cable (provided that the battery is sufficiently charged).

If you want to create a quiet space in a noisy environment, you can simply use the headphones – without cable and disconnected from any Bluetooth device – with ANC activated (> 31).

The Smart Control app allows you to select different ANC modes that offer the optimal settings depending on the application/situation. For example, low-frequency noise can be suppressed, wind noise can be minimized or a possible feeling of pressure on the ears can be avoided.

### Notes on active noise cancellation

- Continuous uniform noise, such as motor or fan noise, is particularly well suppressed.
- Speech or high-frequency noise is significantly reduced, but can remain perceptible.
- In very quiet environments, slight noise may occur. In this case, deactivate ANC.
- If unusual (whistling or beeping) noise occurs, take the headphones off and put them on again. Make sure that the ear cups properly fit around your ears.
- To avoid loud, unusual (whistling or beeping) noise and to ensure proper noise cancellation, do not cover the microphone openings of the active noise cancellation circuitry located on the outside of the ear cups.

## Activating/deactivating the active noise cancellation ANC

To activate the active noise cancellation ANC:

- ▷ Slide the ANC switch to the position:
  - “I” (middle switch position): adjustable ANC mode “USER” (> 23);
  - “II” (lower switch position): maximum ANC mode “MAX”.

To deactivate the active noise cancellation ANC:

- ▷ Slide the ANC switch to the upper position “0”.

Using the headphones

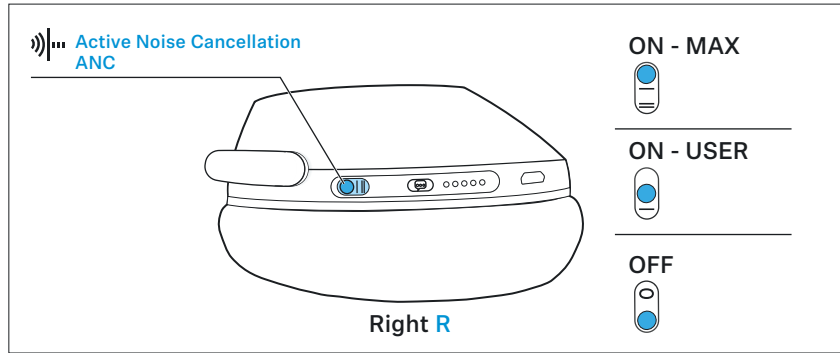

## Setting the ANC USER mode

To be able to set the ANC USER mode, you require the Smart Control app (> 16).

- ▷ In the Smart Control app, select the desired ANC mode that is to be activated for the USER mode:

ANC USER mode	Reduction of low-frequency noise and background noise
“Adaptive” *	Reduction depending on the noise conditions
“Anti Wind”	Slight reduction to minimize disturbing wind or movement noise

\* default setting

## Listening of ambient noise or conversations - activating/deactivating the Transparent Hearing function

The Transparent Hearing function allows you to still hear ambient noise or to communicate without having to remove the headphones when ANC is activated. This allows you to hear e.g. announcements in the train or aircraft or to have short conversations.

To activate or deactivate Transparent Hearing:

- ▷ Briefly tap the touch pad twice.
  - If you are playing music using Bluetooth or the USB cable, the music pauses.
  - If you are playing music using the audio cable, the music is muted.

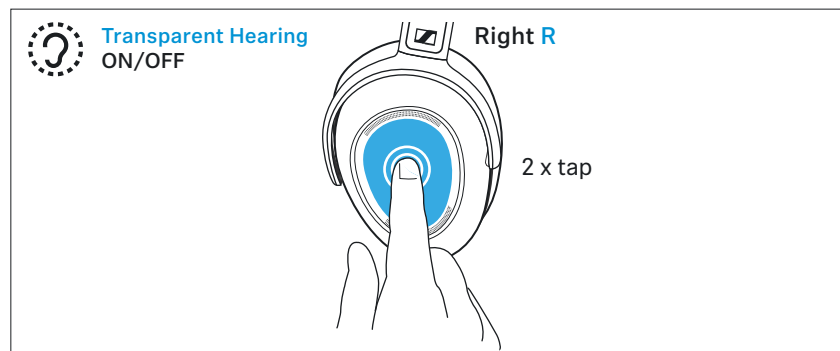

## Listening to music using the headphones

You can listen to music when the headphones and your audio source are connected via Bluetooth (> 13), the USB cable (> 30) or the audio cable (> 30).

## Controlling music playback

The following music functions are only available when the headphones and the device are connected via Bluetooth or the USB cable. Some smartphones or music players may not support all functions.



### Playing/pausing music





▷ Quickly tap the touch pad.

Touch gesture		Function
 1 x tap	Tap 1x	Plays or pauses music

- i** If music playback does not start:
- Check if Transparent Hearing is activated (> 23) and deactivate the function if necessary.
  - Start the music playback app on your Bluetooth device.

### Playing the next/previous track

▷ Quickly swipe horizontally on the touch pad.

Touch gesture	Function
	Plays the next track in the playlist
	Fast-forwards a track
	Plays the previous track in the playlist
	Rewinds a track



## Making phone calls using the headphones

The following call functions are only available when the headphones and the smartphone are connected via Bluetooth or the USB cable. Some smartphones or communication apps may not support all functions.

### Making a call

- ▷ Dial the desired number on your smartphone.  
If your smartphone does not automatically transfer the call to the headphones, select “PXC 550-II” as the audio source on your smartphone (see the instruction manual of your smartphone if necessary).







### Accepting/rejecting/ending a call



If your headphones are connected to a smartphone and you receive a call, you hear the ring tone in the headphones and the LED flashes white rapidly.

If you are playing music when you receive a call, the music pauses until you end the call.



- ▷ Tap the touch pad:

Touch gesture		Function
 1 x tap	Tap 1x	Accepts a call
 1 x tap	Tap 1x	Ends a call Voice prompt “Call ended”
 HOLD 2s	Hold for 2 sec	Rejects a call Voice prompt “Call rejected”
 2 x tap	Tap 2x	Puts an active call on hold
 1 x tap	Tap 1x	Accepts an incoming call and ends the active call
 2 x tap	Tap 2x	Puts the active call on hold and accepts an incoming call

Touch gesture		Function
 2 x tap	Tap 2x	Toggles between active call and call on hold
 HOLD 2s	Hold for 2 sec	Rejects an incoming call and continues the active call

### Muting the microphone

To mute the headphones' microphone during a call:

- ▷ Quickly swipe horizontally backward on the touch pad.  
The microphone is muted. You hear the voice prompt “Mute on”.

To continue the call and reactivate the microphone:

- ▷ Quickly swipe horizontally forward on the touch pad.  
The microphone is reactivated. You hear the voice prompt “Mute off”.

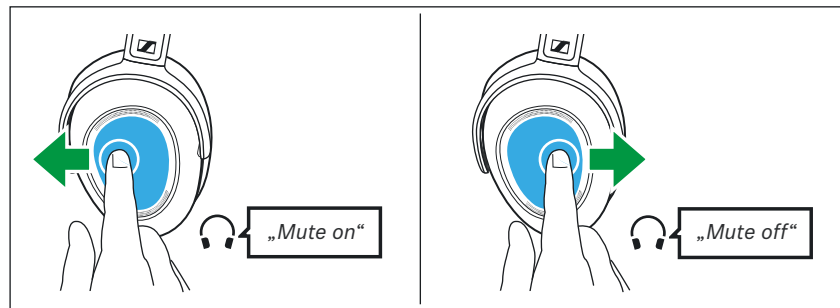

### Putting an active call on hold



If you remove the headphones during a call, the call is automatically put on hold and the microphone is muted. You hear the voice prompt “Mute on” every 30 seconds.

To continue the call and reactivate the microphone, simply put the headphones on again. You hear the voice prompt “Mute off”.

### Transferring a call to/from the headphones

When a connection is established, you can transfer the call from the headphones to the smartphone or from the smartphone to the headphones.



- ▷ Tap the touch pad and hold for 1 second.

Touch gesture		Function
 HOLD 1s	Hold for 1 sec	Transfers a call from the headphones to the smartphone
 HOLD 1s	Hold for 1 sec	Transfers a call from the smartphone to the headphones

### Redialing

The redialing function must be supported by your smartphone or Bluetooth device (with HFP profile). You may have to activate this function on your smartphone.

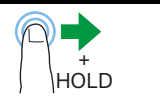
- ▷ Swipe forward on the touch pad and hold.

Touch gesture		Function
	Swipe forward and hold	Redials the last number Voice prompt “Redial”
	Tap 1x	Cancels redialing Voice prompt “Redial canceled”

## Using the voice assistant/voice dialing

- ▷ Press the voice assistant button once.  
The available voice assistant of your smartphone is activated (\* depending on the system or app on your smartphone: Siri, Google Assistant, or others. If no voice assistant is available, voice dialing may be activated).
- ▷ Ask the voice assistant your question or make a request.

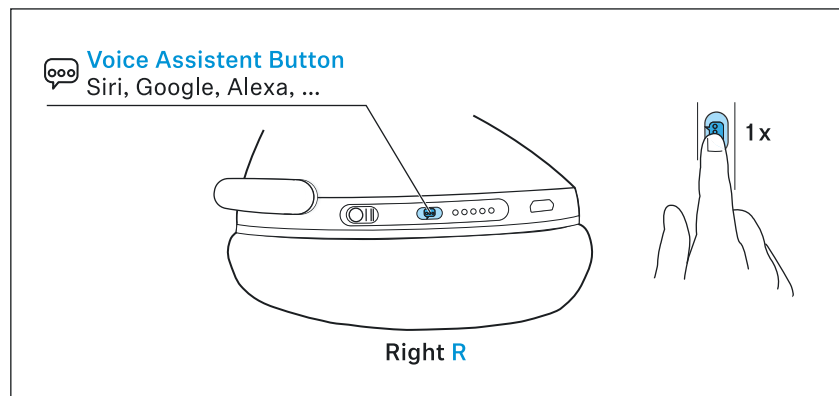

To cancel the voice assistant/voice dialing:

- ▷ Press the voice assistant button once.

**i** If you want to use Amazon Alexa as your voice assistant, you have to configure the headphones once (> 27).

## Using Amazon Alexa as voice assistant

To use Amazon Alexa as a voice assistant, you have to add the headphones to the [Amazon Alexa app](#) as a device once and then activate Alexa via the settings of the [Sennheiser Smart Control app](#):

1. Make sure the headphones are connected to your smartphone via Bluetooth (> 13).
2. Start the [Sennheiser Smart Control app](#) (> 16).
3. In the Smart Control app, open the settings for your headphones and activate Amazon Alexa for the voice assistant button.
4. Start the [Amazon Alexa app](#) and select “Add Device”.
5. From the list of found devices, select “PXC 550-II”.  
You can now use Amazon Alexa by pressing the voice assistant button on your headphones.

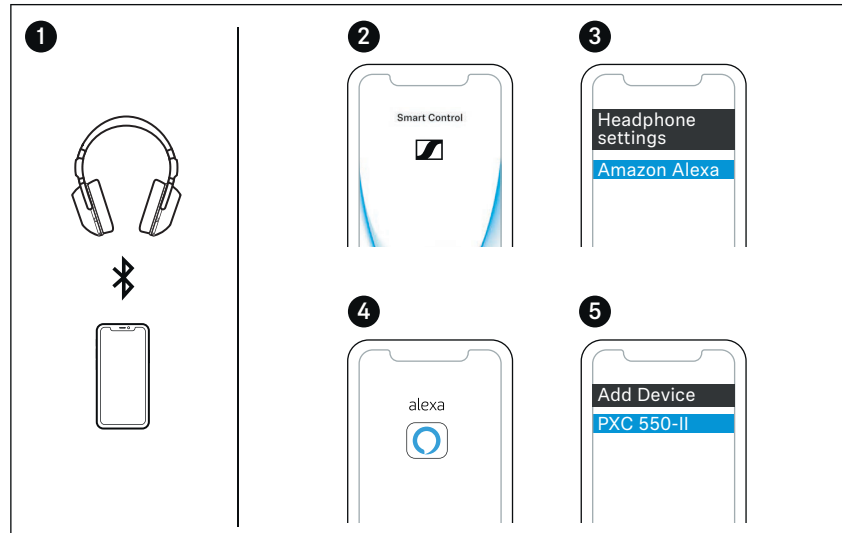

## Using the Smart Pause function

The headphones are equipped with a carrying sensor that automatically detects whether the headphones are worn or removed from your ears. You can use the following functions:

- Music playback pauses when you remove the headphones and continues when you put them on again.
- A call is accepted when you put on the headphones; a call is muted when you remove the headphones during a call and resumed when you put them on again.

You can activate or deactivate the function via the Smart Control app.

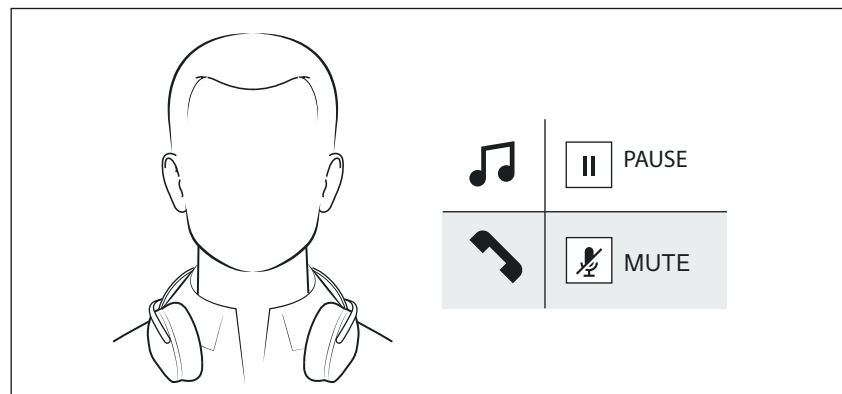

## Adjusting sound effects/the equalizer

To be able to use the sound effects/equalizer, you require the Smart Control app (> 16).

- ▷ In the Smart Control app, select the desired sound effects. The sound effects are stored in the headphones. These sound settings are active even without using the Smart Control app, i.e. when you are using another Bluetooth device.

Sound effect	Meaning/application
Off	Effect mode is switched off.
Movie	For more exciting entertainment. Ideal for movies.
Club	For more room impression. Ideal for music.
Speech	For improved speech intelligibility. Ideal for podcasts and audio books.
Director	Freely adjustable sound effect. Customize the sound categories according to your needs: <ul style="list-style-type: none"> <li>• Boost (boosts certain frequency ranges)</li> <li>• Spatial (simulates virtual external loudspeakers)</li> <li>• Reverb (simulates a virtual room)</li> <li>• DLC (Dynamic Level Control)</li> </ul>

## Activates/deactivates the call enhancement function

This function reproduces the voice of the person you are talking to so naturally that you get the impression that the person is in the same room and not at the other end of the line.

You can activate or deactivate the function via the Smart Control app.

## Setting the voice prompts/beep sounds

To be able to set the voice prompts and beep sounds, you require the Smart Control app (> 16).

- ▷ You can change the language of the voice prompts, choose between voice prompts and beep sounds, or deactivate the status messages with a few exceptions (e.g. rechargeable battery is empty).

## Using the audio cable/activating flight mode

If you connect the audio cable, flight mode is activated and the Bluetooth wireless connection is deactivated.

Use the audio cable when:

- wireless transmission is not allowed, e.g. during aircraft take-off and landing,
- the headphone's rechargeable battery is empty,
- your audio source doesn't offer a Bluetooth connection.

The functions for controlling music and/or calls or voice assistance are not possible. The active noise cancellation ANC can be fully used provided that the rechargeable battery is charged.

You can also activate the flight mode without connecting an audio cable to the headphones (> 31).

## Connecting the headphones using the audio cable

- ▷ Connect the 2.5 mm jack plug of the audio cable to the headphones' audio socket.  
The flight mode is activated and the Bluetooth connection is disabled.
- ▷ Connect the 3.5 mm jack plug to the audio output of your smartphone.

To disconnect the audio cable:

- ▷ Carefully disconnect the jack plug from the headphones.

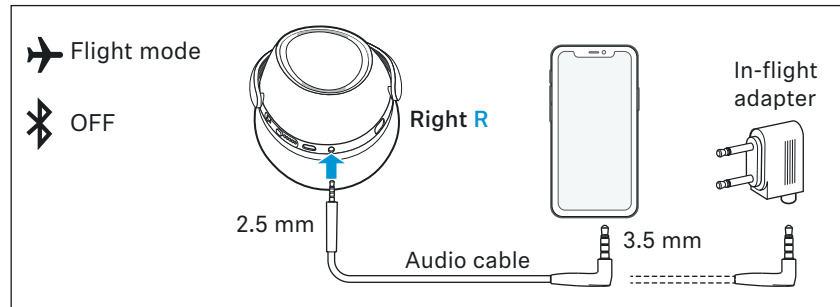

## Using the in-flight adapter

If you are using the in-flight entertainment (IFE) system of your airline, the audio from the IFE may be interrupted by important announcements via the aircraft's public address (PA) system. In most cases, the announcements are much louder than the audio from the IFE. The PXC 550-II detects this and suppresses the volume jump that occurs when there is a switch between PA and IFE system.

The volume of the headphones remains at a low level even after the announcement via the PA system. If you want to increase the volume, adjust it on the IFE system.

- i** If you want to increase the volume on the headphones and the volume cannot be increased as usual, restart the headphones by switching them off and on again.

## Connecting the headphones using the USB cable

When you connect the headphones to a Mac/PC/mobile device using the supplied USB cable, you can play audio content from your Mac/PC/mobile device directly through the headphones.

- i** The headphones are automatically charged when you connect them to a Mac/PC/mobile device using the USB cable.  
If you are using the USB cable and want to deactivate all wireless connections, you have to deactivate Bluetooth on the headphones (> 31).

[Setting up the headphones as the default audio output and input](#)

### device for your Mac/PC/mobile device

- ▷ Make sure that the headphones are connected to the Mac/PC/mobile device using the USB cable.
- ▷ From the Systems Preferences or Control Panel of your Mac/PC/mobile device, select “PXC 550-II” as the default audio output device and/or default audio input device.
- ▷ Start music playback from the Mac/PC/mobile device.  
The music is played through the headphones and the microphone is used for recording.

## Deactivating Bluetooth/activating the flight mode

If, for example, you want to block out aircraft and ambient noise during a flight, you have to deactivate Bluetooth and activate the active noise cancellation ANC.

- ▷ Use the Bluetooth on/off switch to activate or deactivate Bluetooth on the headphones:
  - Activate Bluetooth (“1”) if you want to use the wireless functions of the headphones (e.g. pair the headphones with another device or play music wirelessly).
- ▷ Deactivate Bluetooth (“0”) if wireless Bluetooth transmission is restricted (e.g. during aircraft taxi, take-off, and landing).

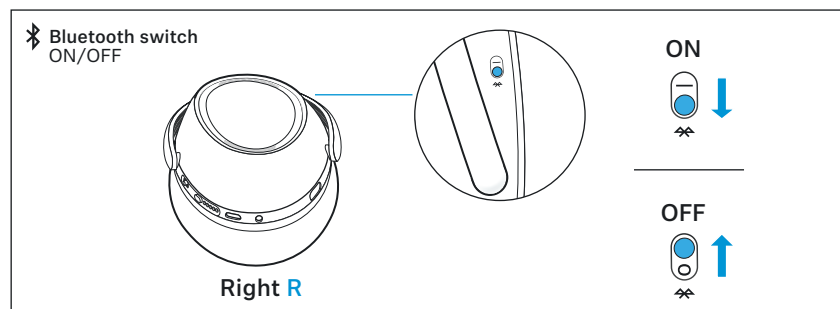

## Storing and transporting the headphones

Store the headphones in the carry case to prevent damage to the headphones when you are not using or transporting them.

- ▷ Fold up the headphones and place them in the carry case as shown in the illustration.

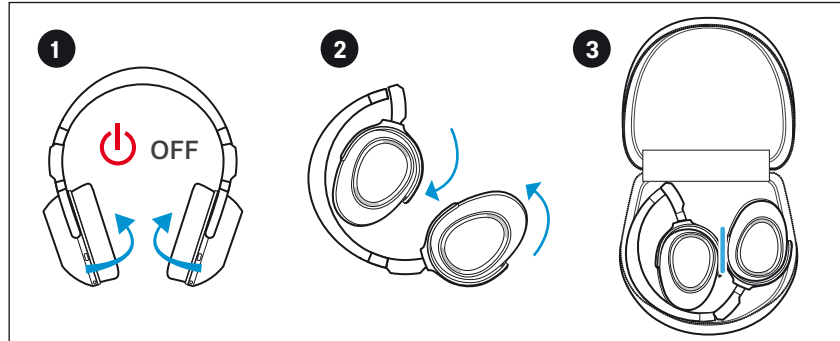



# Care and maintenance

---

## CAUTION

Liquids can damage the electronics of the product!

Liquids entering the housing of the product can cause a short-circuit and damage the electronics.

- ▷ Keep all liquids far away from the product.
  - ▷ Do not use any solvents or cleansing agents.
- 
- ▷ Clean the parts of the product only with a soft, dry cloth.

## Replacing the ear pads

For reasons of hygiene, you should replace the ear pads from time to time. Spare ear pads are available from your Sennheiser partner.

1. Remove the ear pad from the hooks of the ear cup.
2. Attach the new ear pad by hooking the plastic frame of the ear pad into the hooks of the ear cup.
3. Gently pull all sides of the ear pad to ensure that it is properly hooked into all hooks of the ear cup.

## Information on the built-in rechargeable battery

Sennheiser ensures and guarantees that the rechargeable battery performs at its optimum upon purchase of the product. If, upon purchase or within the warranty period, you suspect that the rechargeable battery is obviously defective or if a charging error/battery error is displayed (> 7), stop using the product, disconnect it from the power supply system and immediately return the product to any Sennheiser service partner.

Outside the warranty period, you can have the rechargeable battery replaced for a fee by your Sennheiser service partner. Contact your local Sennheiser partner:

[www.sennheiser.com](http://www.sennheiser.com) > “Service & Support”.

## Installing firmware updates

Firmware updates can be downloaded free of charge from the Internet using the Sennheiser Smart Control app. Sennheiser recommends to always install the latest firmware version to ensure the best performance of your product.

- ▷ Connect the headphones to your smartphone and start the Smart Control app (> 16).
- ▷ The app provides information on available firmware updates and guides you through the installation process.

## FAQ/If a problem occurs ...



### Current list of frequently asked questions (FAQ)

Visit the PXC 550-II product page at

[www.sennheiser.com/download](http://www.sennheiser.com/download)

There you will find a current list of frequently asked questions (FAQ) and suggested solutions.

### Your question has not been answered or the problem persists?

If a problem occurs that is not listed in the FAQ section or if the problem cannot be solved with the proposed solutions, please contact your Sennheiser partner for assistance.

To find a Sennheiser partner in your country, search at [www.sennheiser.com](http://www.sennheiser.com) > “Service & Support”.

### Leaving the Bluetooth transmission range

Wireless calling and streaming are only possible in the Bluetooth transmission range of your smartphone. The transmission range largely depends on environmental conditions such as wall thickness, wall composition etc. With a free line of sight, the transmission range of most smartphones and Bluetooth devices is up to 10 meters. If you, and therefore the headphones, leave the Bluetooth transmission range of the smartphone, the sound quality deteriorates increasingly until you hear the voice prompt “Device (1) disconnected” and the connection breaks down completely. If you immediately re-enter the Bluetooth transmission range, the connection is automatically re-established.

### Deleting the Bluetooth pairing list of the headphones

Make sure that Bluetooth is deactivated on the headphones.

1. Restart the headphones by switching them off and on again (> 18 and 17).
2. Press the voice assistant button for 4 seconds.  
You hear beep sounds and the voice prompts “Device (1) disconnected” and “Pairing”. The LEDs flash white one after the other.
3. Press the voice assistant button again for 4 seconds.  
The Bluetooth pairing list is deleted. You hear the voice prompt “Pairing list cleared”. The LEDs flash white one after the other. The headphones then stay in Bluetooth pairing mode.

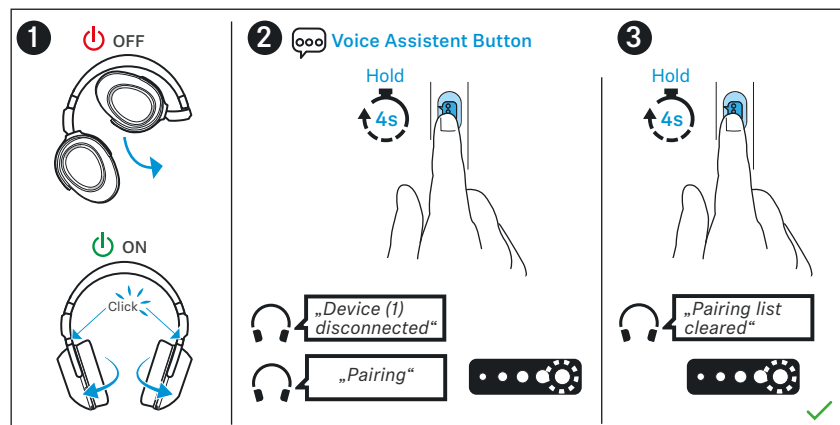

### Resetting the headphones to the factory default settings/Reset

1. Switch the headphones off (> 18).
2. Press the voice assistant button for 4 seconds.

The Smart Control app also allows you to reset the headphones to the factory default settings (e.g. EQ settings, ANC mode).

# Specifications

## Model: SEBT5

Ear coupling	circum-aural
Transducer principle	dynamic, closed-back
Transducer	32 mm
Frequency response	17 Hz to 23 kHz
Sound pressure level (SPL)	110 dB (passive: 1 kHz/1 Vrms)
Impedance	active mode: 490 $\Omega$ passive mode: 46 $\Omega$
THD (1 kHz, 100 dB SPL)	< 0.5 %
Noise cancellation	ANC technology with 4 pick-up microphones
Total noise attenuation	up to 30 dB
Pick-up pattern (speech audio)	3-mic beamforming array
Power supply	built-in rechargeable lithium-polymer battery: 3.7 V, 700 mAh USB charging: 5 V $\overline{\text{DC}}$ , 345 mA
Charging time of rechargeable battery	approx. 3 hours
Operating time	20 hours (Bluetooth and ANC activated) 30 hours (only ANC activated, with or without audio cable for flight mode)
Temperature range	<i>operation</i> : 0 to +40 °C <i>storage</i> : -20 to +60 °C
Relative humidity	<i>operation</i> : 10 to 80%, non condensing <i>storage</i> : 10 to 90%
Weight (headphones)	approx. 227 g
Magnetic field strength	4.3 mT

## Bluetooth

Version	Bluetooth 5.0 compatible, class 1
Transmission frequency	2,402 MHz to 2,480 MHz
Modulation	GFSK, $\pi/4$ DQPSK, 8DPSK
Output power	10 mW (max)
Profiles	HSP, HFP, AVRCP, A2DP, DIP
Codec	aptX, aptX LL, AAC, SBC
Device name	PXC 550-II LE-PXC 550-II (Bluetooth Low Energy only)

# Manufacturer Declarations

## Warranty

Sennheiser electronic GmbH & Co. KG gives a warranty of 24 months on this product.

For the current warranty conditions, please visit our website at [www.sennheiser.com](http://www.sennheiser.com) or contact your Sennheiser partner.

## In compliance with the following requirements

- General Product Safety Directive (2001/95/EC)
- Compliant to **Sound Pressure Limits** according to country specific requirements

## EU declaration of conformity



- RoHS Directive (2011/65/EU)

Hereby, Sennheiser electronic GmbH & Co. KG declares that the radio equipment type SEBT5 is in compliance with the Radio Equipment Directive (2014/53/EU).

The full text of the EU declaration of conformity is available at the following Internet address: [www.sennheiser.com/download](http://www.sennheiser.com/download).

## Notes on disposal



- WEEE Directive (2012/19/EU)
- Battery Directive (2006/66/EC & 2013/56/EU)

The symbol of the crossed-out wheeled bin on the product, the battery/rechargeable battery (if applicable) and/or the packaging indicates that these products must not be disposed of with normal household waste, but must be disposed of separately at the end of their operational lifetime. For packaging disposal, please observe the legal regulations on waste segregation applicable in your country.

Further information on the recycling of these products can be obtained from your municipal administration, from the municipal collection points, or from your Sennheiser partner.

The separate collection of waste electrical and electronic equipment, batteries/rechargeable batteries (if applicable) and packaging is used to promote the reuse and recycling and to prevent negative effects caused by e.g. potentially hazardous substances contained in these products. Herewith you make an important contribution to the protection of the environment and public health.

## Trademarks

Sennheiser is a registered trade mark of Sennheiser electronic GmbH & Co. KG.

Apple, the Apple logo, iPhone, iPod, iPod touch, iPad, and Siri are trademarks of Apple Inc., registered in the U.S. and other countries. App Store is a service mark of Apple Inc. The trademark "iPhone" is used with a license from Apple Inc.

The Bluetooth® word mark and logos are registered trademarks owned by the Bluetooth SIG, Inc. and any use of such marks by Sennheiser electronic GmbH & Co. KG is under license.

The aptX mark and the aptX logo are trademarks of CSR plc or one of its group companies and may be registered in one or more jurisdictions.

Android and Google Play are registered trademarks of Google Inc.

## Manufacturer Declarations

Amazon, Alexa and all related logos are trademarks of Amazon.com, Inc. or its affiliates.

Other product and company names mentioned in the user documentation may be the trademarks or registered trademarks of their respective holders.