



NA64H3030AK

NA64H3040AS

NA64H3010AK

NA64H3030AS

NA64H3000AK

NA64H3010AS

NA64H3030BK

NA64H3110AS

NA64H3010BK

NA64H3040BS

NA64H3010CK

NA64H3030BS

NA64H3010CE

NA64H3010BS

NA64H3110BS

Gas cooktop

user manual

**Planet
First** 100 %
Recycled Paper

This manual is made with 100 % recycled paper.

ENGLISH

imagine the possibilities

Thank you for purchasing this Samsung product.

To receive more complete service, please register your product at
www.samsung.com/register

SAMSUNG

Preface

Thank you for choosing a Samsung gas cooktop.

To use this appliance correctly and prevent any potential risk, read these instructions before using the appliance.

Keep these instructions in a place where you can find them easily.

If you are unsure of any of the information contained in these instructions, please contact the Samsung customer care centre

The manufacturer shall not be responsible for any damages to persons or property caused by incorrect installation or use of the appliance.

The appliance has been certified for use in countries other than those marked on the appliance.

The manufacturer also reserves the right to make any modifications to the products as may be considered necessary or useful, also in the interests of the user, without jeopardising the main functional and safety features of the products themselves.

The appliance is designed for a domestic environment and not a commercial one.

Preface

Safety Warning

3-8

- 3 Safety Instructions
- 4 Installation
- 5 Child and People Safety
- 6 During Use
- 8 Cleaning and Service
- 8 Environmental Information

Instructions for use and maintenance

9-18

- 9 Description of the appliance
- 13 How to Use the appliance
- 15 Safety and Energy saving advice
- 17 Cleaning and Maintenance



Technical instructions

19-30

- 19 Using instructions
- 20 Positioning
- 21 Installing the appliance
- 22 Gas Connection
- 23 Electrical Connection
- 24 Gas Conversion
- 25 Engineers technical data
- 29 Burner Features
- 30 Troubleshooting

safety instructions

- Your safety is of the utmost importance to Samsung.
- Please take the time to read this Instruction Manual before installing or using the appliance.
- This instruction booklet must be kept with the appliance for any future reference.
If the appliance is sold or transferred to another person, ensure the booklet is passed on to the new user.
- The manufacturer declines any liability should these safety measures not be observed.
- The following marks are made to be easily understood so that you can prevent any accident caused by misuse in advance, and use the appliance more conveniently.
- Read the following contents thoroughly and ensure you understand them.

 Danger/Warning	Neglect of this mark may result in severe personal injury or death.
 Caution	Neglect of this mark may result in minor personal injury or property damage.

■ The following marks are used in the Instruction Manual as follows:



Caution



No Access



No Fire Tool



Must Do

Danger

■ If gas seems to leak, take the actions as follow :

- Do not turn on the light.
- Do not switch on/off any electrical appliance and do not touch any electric plug.
- Do not use a telephone.

- 1 Stop using the product and close the middle valve.
- 2 Open the window to ventilate.
- 3 Contact our service centre by using a phone outside.



* The fuel gas contains mercaptan, so that you can smell the gas leak (smell of rotten garlic or egg) even where only 1/1000 of the gas is in the air.

Warning

- This appliance shall be installed in accordance with regulations in force and only used in a well ventilated space.



- Prior to installation, ensure that the gas and electrical supply complies with the type stated on the rating plate.



- Where this appliance is installed in marine craft or in caravans, it should not be used as a space heater.

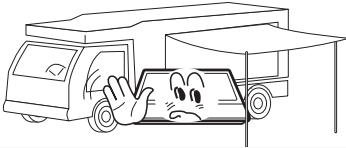

- The gas pipe and electrical cable must be installed in such a way that they do not touch any parts or the appliance.



Caution

- This appliance should be installed by a qualified technician or installer.
- The adjustment conditions for this appliance are stated on the label or data plate.
- Remove all packaging before using the appliance.
- After unpacking the appliance, make sure the product is not damaged and that the connection cord is in perfect condition. Otherwise, contact the dealer before installing the appliance.
- The adjacent furniture and all materials used in the installation must be able to withstand a minimum temperature of 85°C above the ambient temperature of the room it is located in, whilst in use.
- In the event of burner flames being accidentally extinguished, turn off the burner control and do not attempt to re-ignite the burner for at least one minute.
- The use of a gas cooking appliance results in the production of heat and moisture in the room in which it is installed. Ensure that the kitchen is well ventilated: keep natural ventilation holes open or install a mechanical ventilation device (mechanical extractor hood).
- Prolonged intensive use of the appliance may call for additional ventilation, for example opening of a window, or more effective ventilation, for example increasing the level of mechanical ventilation where present.

Warning

- Do not allow children to play near or with the appliance.
The appliance gets hot when it is in use.
Children should be kept away until it has cooled.

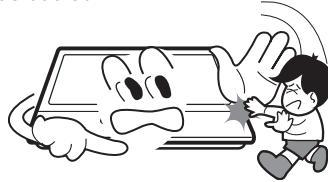

Caution

- This appliance is designed to be operated by adults.
- Children can also injure themselves by pulling pans or pots off the appliance.
- This appliance is not intended for use by children or other persons whose physical, sensory or mental capabilities or lack of experience and knowledge prevents them from using the appliance safely without supervision or instruction by a responsible person to ensure that they can use the appliance safely.

Warning

- Only use the appliance for preparing food.



- Do not modify this appliance. Burner panel is not designed to operate from an external timer or separate remote control system.

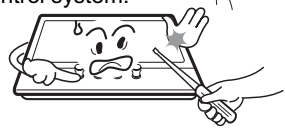

- The use of a gas cooking appliance results in the production of heat and moisture in the room in which it is installed. Ensure that the kitchen is well ventilated : keep natural ventilation holes open or install a mechanical ventilation device (mechanical extractor hood).



- Do not use this appliance if it comes in contact with water. Do not operate this appliance with wet hands.



- The heating and cooking surfaces of the appliance become hot when they are in use, take all due precautions.



- Do not use large cloths, tea towels or similar as the ends could touch the flames and catch fire.



- Never leave the appliance unattended when cooking.



- Unstable or misshapen pans should not be used on the appliance as they can cause an accident by tipping or spillage.



during use

- Do not use or store flammable materials in the storage drawer near this appliance.



- Perishable food, plastic items and aerosols may be affected by heat and should not be stored above or below the appliance.



- Do not spray aerosols in the vicinity of this appliance while it is in operation.



- Ensure the control knobs are in the '●' position when not in use.

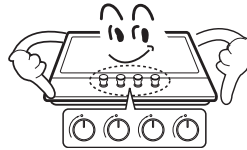

Caution

- This appliance is intended for domestic cooking only. It is not designed for commercial or industrial purposes.
- Prolonged intensive use of the appliance may call for additional ventilation, for example opening of a window, or increasing the level of mechanical ventilation where present.
- Use heat-resistant pot holders or gloves when handling hot pots and pans.
- Do not let pot holders come near open flames when lifting cookware.
- Take care not to let pot holders or gloves get damp or wet, as this causes heat to transfer through the material quicker with the risk of burning yourself.
- Only ever use the burners after placing pots and pans on them. Do not heat up any empty pots or pans.
- Never use plastic or aluminium foil dishes on the appliance.
- When using other electrical appliances, ensure the cable does not come into contact with the appliance surfaces of the cooking appliance.
- If you have any mechanical parts eg. an artificial heart in your body, consult a doctor before using the appliance.
- Do not use a tea towel or similar materials in place of a pot holder. Such cloths can catch fire on a hot burner.
- When using glass cookware, make sure it is designed for top plate cooking. If the surface is made of glass-cracked, switch off the appliance to avoid defeat electrocution.
- To minimise the possibility of burns, ignition of flammable materials and spillage, turn cookware handles toward the side or center of the top plate without extending over adjacent burners.
- Always turn burner controls off before removing cookware.
- Carefully watch foods being fried at a high flame setting.
- Always heat fat slowly and watch as it heats.
- Foods for frying should be as dry as possible. Frost on frozen foods or moisture on fresh foods can cause hot fat to bubble up and over the sides of the pan.
- Never try to move a pan of hot fat, especially a deep fat fryer. Wait until the fat is completely cool.

⚠ Warning

- Never use abrasive or caustic cleaning agents.



- This appliance should only be repaired or serviced by an authorised Service Engineer and only genuine approved spare parts should be used.

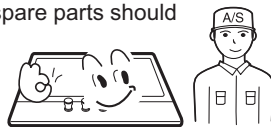

⚠ Caution

- Before attempting to clean the appliance, it should be disconnected from the mains and cooled.
- You should not use a steam jet or any other high pressure cleaning equipment to clean the appliance.

environmental information

- After installation, please dispose of the packaging with due regard to safety and the environment.
- When disposing of an old appliance, make it unusable, by cutting off the cable.



Correct Disposal of This Product (Waste Electrical & Electronic Equipment)

- This marking shown on the product or its literature, indicates that it should not be disposed with other household wastes at the end of its working life. To prevent possible harm to the environment or human health from uncontrolled waste disposal, please separate this from other types of wastes and recycle it responsibly to promote the sustainable reuse of material resources.
- Household users should contact either the retailer where they purchased this product, or their local government office, for details of where and how they can take this item for environmentally safe recycling.
- Business users should contact their supplier and check the terms and conditions of the purchase contract. This product should not be mixed with other commercial wastes for disposal.

description of the appliance

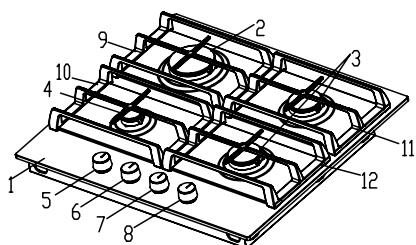

NA64H3010AK/NA64H3000AK

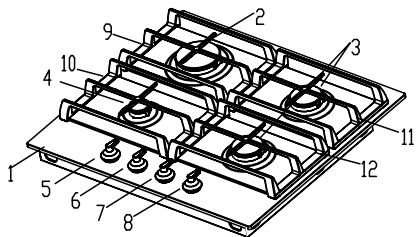

NA64H3010CK/NA64H3010CE

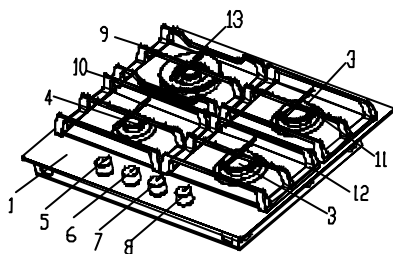

NA64H3030AK

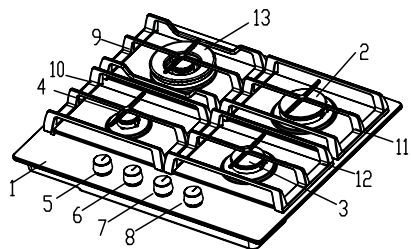

NA64H3030AS/NA64H3040AS

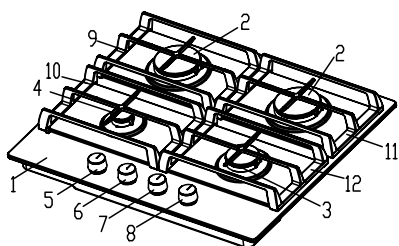

NA64H3010AS

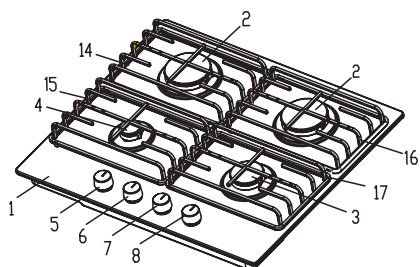

NA64H3110AS

- 1.top plate
- 2.rapid burner
- 3.semi-rapid burner
- 4.auxiliary burner
- 5.control knob for left lower burner
- 6.control knob for upper left burner
- 7.control knob for upper right burner
- 8.control knob for low right burner

- 9.pan support upper left(cast iron)
- 10.pan support left lower(cast iron)
- 11.pan support upper right(cast iron)
- 12.pan support low right(cast iron)
- 13.triple burner
- 14.pan support left upper(enamel)
- 15.pan support left lower (enamel)
- 16.pan support right upper(enamel)
- 17.pan support right lower(enamel)

description of the appliance

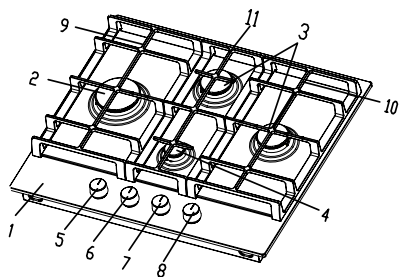

NA64H3010BK

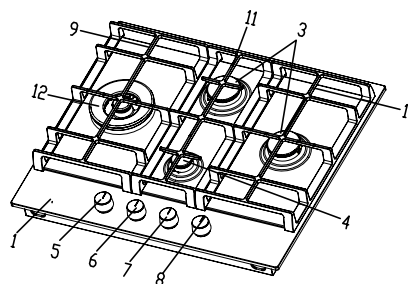

NA64H3030BK

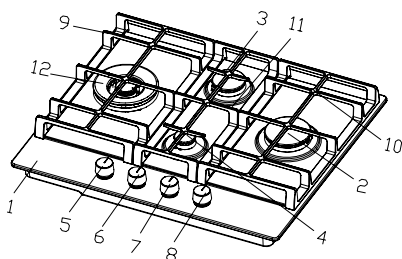

NA64H3030BS/NA64H3040BS

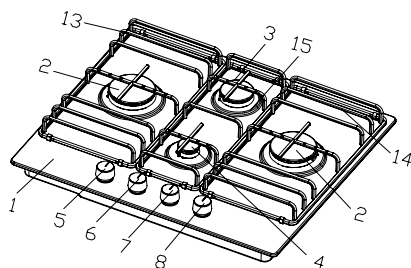

NA64H3110BS

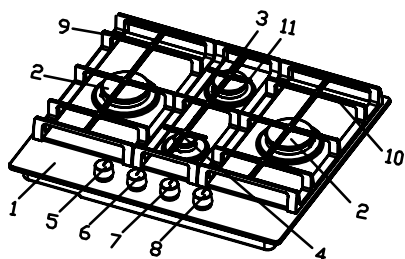

NA64H3010BS

- 1.top plate
- 2.rapid burner
- 3.semi-rapid burner
- 4.auxiliary burner
- 5.control knob for left burner(rapid burner)
- 6.control knob for lower burner(auxiliary burner)
- 7.control knob for upper burner(semi-rapid burner)
- 8.control knob for right burner(rapid burner)

- 9.pan support left(cast iron)
- 10.pan support right(cast iron)
- 11.pan support middle(cast iron)
- 12.triple burner
- 13.pan support left(enamel)
- 14.pan support right(enamel)
- 15.pan support middle(enamel)

description of the appliance

Burner

Triple Crown (NA64H3030**, NA64H3040**) Auxiliary, Semi-rapid and Rapid

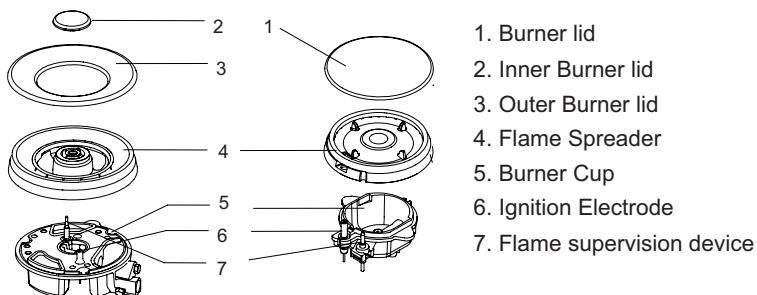

Wok pan support

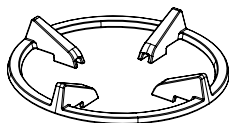

(Some models)

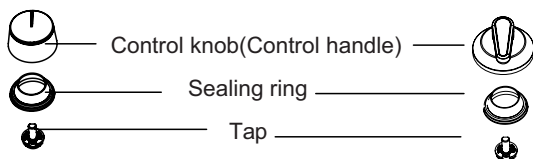

Knob



(NA64H3010CK, NA64H3010CE)

description of the appliance

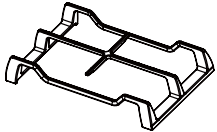
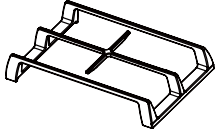
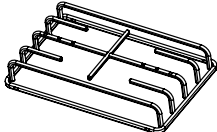
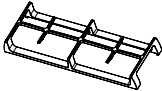
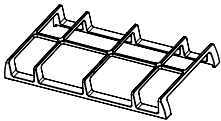
Pan support

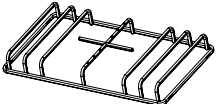
pan support	Burner	Model
	Triple	NA64H3030AS NA64H3030AK
	Rapid Semi-rapid Auxiliary	NA64H3040AS NA64H3030AS NA64H3010AS NA64H3030AK NA64H3010AK NA64H3000AK NA64H3010CK NA64H3010CE
	Rapid Semi-rapid Auxiliary	NA64H3110AS
	Semi-rapid Auxiliary	NA64H3040BS NA64H3030BS NA64H3010BS NA64H3030BK NA64H3010BK
	Triple Rapid Semi-rapid	NA64H3040BS NA64H3030BS NA64H3010BS NA64H3030BK NA64H3010BK
	semi-rapid Auxiliary	NA64H3110BS
	Rapid	NA64H3110BS

description of the appliance

Accessories

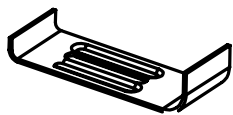

Bracket(4)

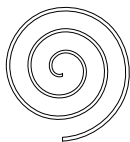

Sponge(4)



Screw(4)



Injector(4)



Connector and Gasket(1)



Instruction Manual(1)

how to use the appliance

Turn on

1 Preparation

The following symbols will appear on the control panel, next to each control handle :

	Circle : gas off		Small flame : minimum setting
	Large flame : maximum setting		Ignition position

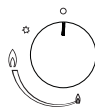

- The minimum setting is at the end of the anti-clockwise rotation of the control handle.
- All operation positions must be selected between the maximum and minimum position.
- The symbol on the control panel, next to the control handle will indicate which burner it operates.

2 Ignition & Adjustment

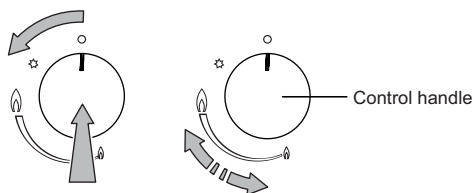

how to use the appliance

- Place a pot or a pan on the corresponding cooking position.
- Fully press down the control handle for the corresponding cooking position and turn it to the left, to the ignition position, and hold it there for a few seconds at most until the burner ignites.
- After igniting, keep the control handle pressed for about 5–8 seconds more because the heat sensor that opens the gas channel has to warm up first. Set control handle to the position you want.
- If the burner does not light, repeat the process.
- The flame size can be set continuously between maximum and minimum by slowly turning the control handle.



- If the igniters are dirty, this makes the burner harder to light, so you should keep them as clean as possible. Do this with a small brush and make sure that the ignition device is not hit or knocked violently.
- The flame supervision device shall not be operated for more than 15 seconds. If after 15 seconds the burner has not lit, stop operating the device and open the compartment door and/or wait at least one minute before attempting to reignite the burner.

Turn off

3 Extinguishment

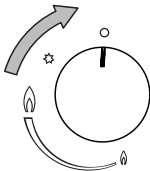

- Turn the control handle to clockwise, to setting ‘o’ (off position)



- Right after extinguishment, the appliance is still hot. Be careful not to burn yourself.



- This appliance is fitted with a flame failure safety device which cuts off the supply of gas to a burner if the flame goes out, for example if food has boiled over, or if there is a sudden draught.
- In the event of the burner flames being accidentally extinguished, turn off the burner control and do not attempt to re-ignite the burner for at least one minute.

safety and energy saving advice

- The diameter of the bottom of the pan should correspond to that of the burner.

BURNERS	PANS	
	min.	max.
Triple-Crown	200mm	260mm
Rapid	200mm	260mm
Semi-Rapid	120mm	140mm
Auxiliary	100mm	120mm



■ Do not use cookware that overlaps the edge of the burner.

NO		YES	
	Do not use small diameter cookware on large burners. The flame should never come up the sides of the cookware.	Always use cookware that is suitable for each burner, to avoid wasting gas and discolouring the cookware.	
	Avoid cooking without a lid or with the lid half off - as this wastes energy	Place a lid on the cookware.	
	Do not use a pan with a convex or concave bottom.	Only use pots, saucepans and frying pans with a thick, flat bottom.	
	Do not place cookware on one side of a burner, as it could tip over. Do not use cookware with a large diameter on the burners near the controls, which when placed on the middle of the burner may touch the controls or be so close to them that they increase the temperature in this area and may cause damage.	Always place the cookware right over the burners, not to one side.	
	Never place cookware directly on top of the burner.	Place the cookware on top of the trivet.	
	Do not place anything, eg. flame tamer, asbestos mat, between pan and pan support as serious damage to the appliance may result.		
	Do not use excessive weight and do not hit the cooktop with heavy objects.	Handle cookware carefully when they are on the burner.	



- It is not recommended to use roasting pans, frying pans or grill stones heated simultaneously on several burners because the resulting heat build-up may damage the appliance.
- Do not touch the top plate and trivet whilst in use for a certain period after use.



- As soon as a liquid starts boiling, turn down the flame so that it will barely keep the liquid simmering.

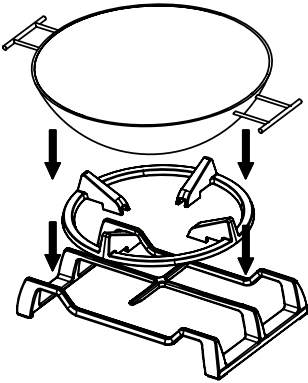

This "WOK PAN SUPPORT" allows you to use receptacles with a concave base.

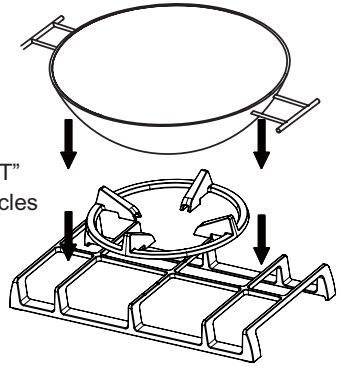

- "WOK PAN SUPPORT" is mainly used for triple crown burner.(NA64H3030AS)
- "WOK PAN SUPPORT" is mainly used for rapid burner. (NA64H3010AK, NA64H3010CK, NA64H3010CE)
- The manufacturer declines all responsibility if this additional wok pan support is not used or are used incorrectly.
- Do not use other pan support for triple burner.

CONCAVE PAN	
Φ min.	Φ max.
120mm	200mm

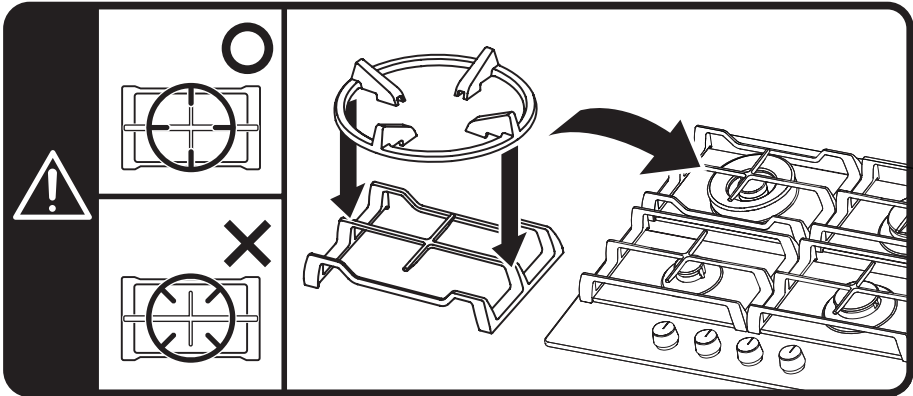









Usage of Wok Pan Support .

cleaning and maintenance



- Cleaning operations must only be carried out when the appliance is **completely cool**.
- The appliance should be disconnected from your mains supply before commencing any cleaning process.
- Clean the appliance regularly, preferably after each use.
- Abrasive cleaners or sharp objects will damage the appliance surface; you should clean it using water and a little washing up liquid.

Usable	Unusable	
 Soft cloth	 Nylon Brush	 Metal Brush
 Neutral Detergent	 Edible Oil	 Acidic/Alkali Detergent
	 Abrasive	 Thinner/Benzene

Pan support, Control handles

- Take off the Pan support.
- Clean these and the control handles with a damp cloth, washing up liquid and warm water. For stubborn soiling, soak beforehand.
- Dry everything with a clean soft cloth.

Top plate

- Regularly wipe over the top plate using a soft cloth well wrung-out in warm water to which a little washing up liquid has been added.
- Dry the top plate thoroughly after cleaning.
- Thoroughly remove salty foods or liquids from the hob as soon as possible to avoid the risk of corrosion.
- Stainless steel parts of the appliance may become discoloured over time. This is normal because of the high temperatures. Each time the appliance is used these parts should be cleaned with a product that is suitable for stainless steel.

BURNERS

- Remove the burner lids and Flame Spreaders by pulling them upwards and away from the top plate.
- Soak them in hot water and a little detergent or washing up liquid
- After cleaning and washing them, wipe and dry them carefully. Make sure that the flame holes are clean and completely dry.
- Wipe the fixed parts of the burner cup with a damp cloth and dry afterwards.
- Gently wipe the ignition device and flame supervision device with a well wrung-out cloth and wipe dry with a clean cloth.
- Before placing the burners back on the top plate, make sure that the injector is not blocked.

■ Re-assemble the Auxiliary, Semi-Rapid, Rapid and Triple-Crown burners as follows :

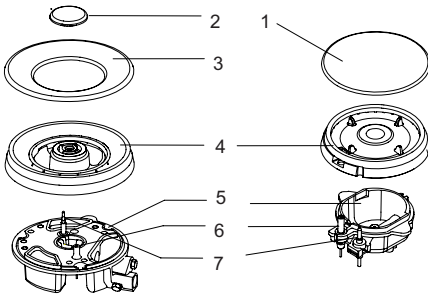

1. Place the flame spreader (4) on to the burner cup (5) so that the ignition device and the flame supervision device extend through their respective holes in the flame spreader. The flame spreader must click into place correctly.
2. Position the burner lid (1, 2, 3) onto the flame spreader (4) so that the retaining pins fit into their respective recesses.



Replace parts in the correct order after cleaning.

- Do not mix up the top and bottom.
- The locating pins must fit exactly into the notches.

Warnings

- Do not modify this appliance.
- This appliance must be installed by an authorised technician or installer.
- Prior to installation, ensure that the local distribution conditions (nature of the gas and gas pressure) and the adjustment of the appliance are compatible.
- The adjustment conditions for this appliance are stated on the label (or data plate).
- This appliance is not connected to a combustion products evacuation device. It should be installed and connected in accordance with current installation regulations. Particular attention should be given to the relevant requirements regarding ventilation.
- Before installing, turn off the gas and electricity supply to the appliance.
- All appliances containing any electrical components must be earthed.
- Ensure that the gas pipe and electrical cable are installed in such a way that they do not touch any parts of the appliance which may become hot.
- Gas pipe or connector shouldn't be bent or blocked by any other appliances.
- Check the dimensions of the appliance as well as the dimensions of the gap to be cut in the kitchen unit.
- The panels located above the work surface, directly next to the appliance, must be made of non-flammable material. Both the stratified surfacing and the glue used to secure it should be heat resistant, to prevent deterioration.
- Turn on appliance tap and light each burners.
Check for a clear blue flame without yellow tipping.
If burners shows any abnormalities check the following :
 - Burner lid on correctly
 - Flame spreader positioned correctly
 - Burner vertically aligned with injector nipple
- A full operational test and a test for possible leakages must be carried out by the fitter after installation.
- The flexible hose shall be fitted in such a way that it cannot come into contact with a moveable part of the housing unit and does not pass through any space susceptible of becoming congested.
- Grease cranes produced at the factory to meet the requirement of all life hob.

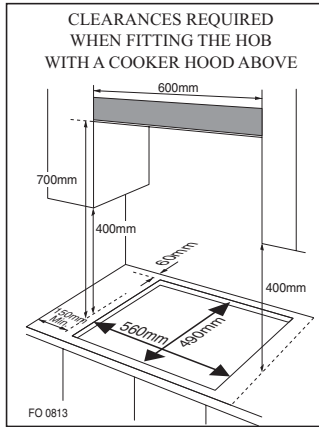
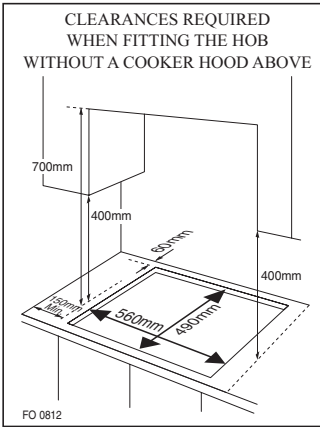

Cut out size

Width : 560mm

Depth : 490mm

Thickness : 30~50mm

■ This appliance is to be built into a kitchen unit or 600mm worktop, providing the following minimum distances are allowed ;

- The cut-out position must be a minimum distance of 60mm from a rear wall.
- A minimum distance of 150mm must be left between the side edges of the appliance and any adjacent cabinets or walls.
- The minimum distance combustible material can be fitted above the appliance in line with the edges of the appliance is 400mm. If it is fitted below 400mm a space of 50mm must be allowed from the edges of the appliance.
- The minimum distance combustible material can be fitted directly above the appliance is 700mm.
- This panel(a) must be positioned at a maximum distance of 150mm below the worktop.
- This panel is not mandatory for application.

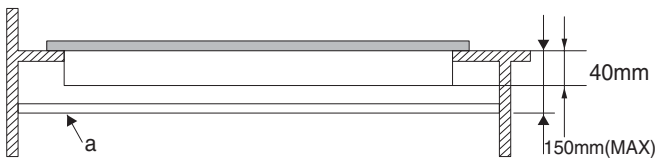

- An oven must have forced ventilation to install a hob above it.
- Check the dimensions of the oven in the installation manual.
- The cut out size must obey the indication.

installing the appliance

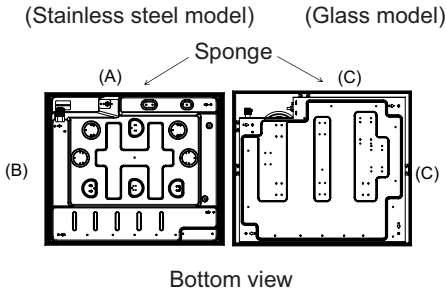

1. Remove the pan supports, the burner lid and flame spreader and carefully turn the appliance upside down and place it on a cushioned mat. Take care that the Ignition devices and flame supervision devices are not damaged in this operation.
2. Apply the sponge provided around the edge of the appliance.
3. Do not leave a gap in the sealing agent or overlap the thickness.

The thickness of the sponge is 1.5mm The thickness of the sponge is 4mm
 (A)The width of the sponge is 11mm (C)The width of the sponge is 10mm
 (B)The width of the sponge is 20mm

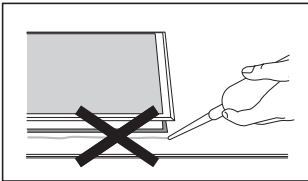

Do not use a silicon sealant to seal the appliance against the aperture.

This will make it difficult to remove the appliance from the aperture in future, particularly if it needs to be serviced.

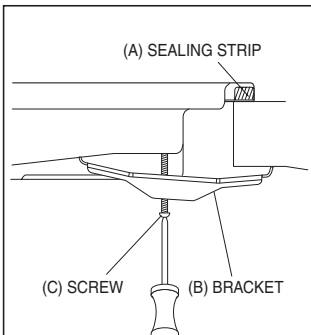

1. Place the bracket(B) over the holes that match the size of the screws. There are one set of screw holes in each corner of the hob(H). Slightly tighten a screw(C) through the bracket(B) so that the bracket is attached to the hob, but so that you can still adjust the position.
2. Carefully turn the hob back over and then gently lower it into the aperture hole that you have cut out.
3. On the underneath of the hob, adjust the brackets into a position that is suitable for your worktop. Then fully tighten the screws(C) to secure the hob into position.

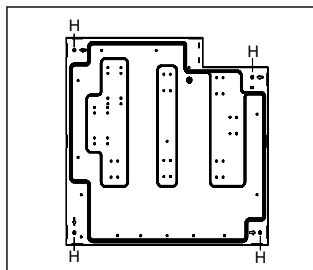
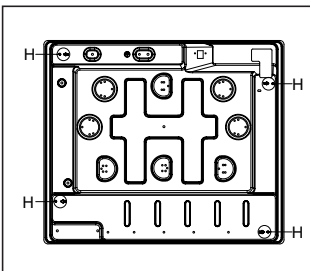



- This appliance must be installed and connected in accordance with installation regulations in force in the country in which the appliance is to be used.
- This appliance is supplied to run on natural gas only and cannot be used on any other type of gas without modification. Conversion for use on LPG and other gases must only be undertaken by a qualified person.

The gas inlet connection fitting is 1/2 inch female thread.

Gas distributed by pipe ; natural gas, propane-air gas or butane-air gas

For your safety, you must choose from the three following connection options.

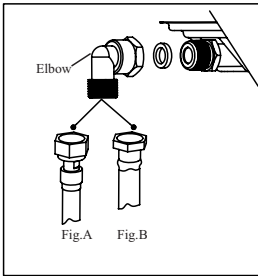

- **Connection with a rigid pipe** made from copper and with screw-on mechanical connectors. Make the connection directly to the end of the elbow fitted on the appliance.
- **Connection using flexible undulated metal tube with screw-on connectors.** (Fig. A) You can use a flexible stainless steel pipe available from your after sales service department.
- **Connection using flexible tube with screw-on connectors.** (Fig.B) These tubes must not exceed 2 meters in length and must be accessible along their entire length.

Gas supplied by tank or cylinder (butane/propane)

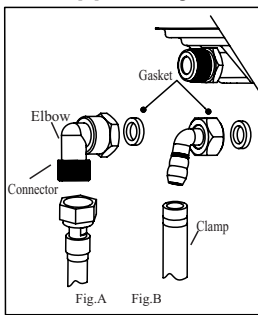

- For the user's safety, we advise the connection to be made with a rigid pipe if this is possible, using a flexible undulated metal tube with screw-on connectors (maximum length 2meters) (Fig.A)
- For an existing installation, where it is not possible to fit a reinforced, braided, flexible gas hose, the connection can be made with a flexible gas hose (maximum length 2meters), with two clamps. One on the connector, and the other on the pressure regulator, and a gasket should be fitted between the connector and the hob's elbow. (Fig.B)



- You can obtain the connector and the gasket from your After-Sales Service. In France, you must use a tube or a pipe featuring the "NF Gaz" logo. **You should check the local installation regulation regarding the permitted the use of certain type of flexible gas tube.**



- A full operational test and a test for possible leakages must be carried out by the fitter after installation.
- Access to the whole length of the connection hose must be possible and the gas hose must be replaced before its use before the end of service life (indicated on the hose).

electrical connection

- This appliance must be earthed.
- This appliance is designed to be connected to a 220~240V, 50/60Hz AC electricity supply.
- The wires in the mains lead are coloured in accordance with the following code ;
 - Green/yellow = Earth
 - Blue = Neutral
 - Brown = Live



- The wire which is coloured green and yellow must be connected to the terminal which is marked with the letter E or by the earth symbol.



■ WIRING DIAGRAM

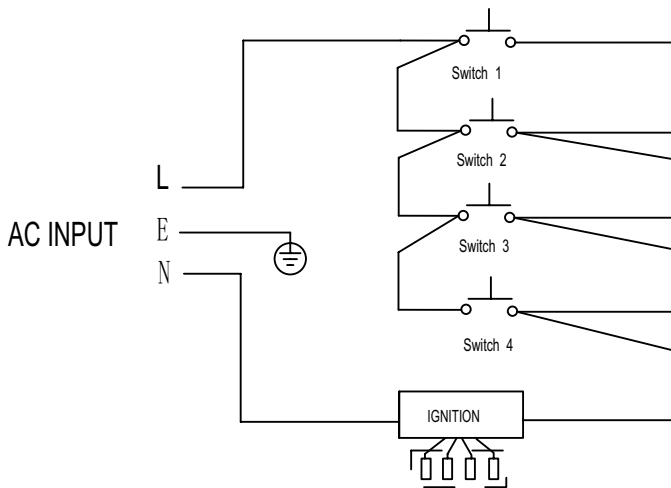

When the power cord is damaged it must be replaced by the manufacturer to produce, customer service agent or similarly qualified personnel.



- Take precautions on the operations and adjustments to be carried out when converting from one gas to another.
- All work must be carried out by a qualified technician.
- Before you begin, turn off the gas and electricity supply to the appliance.

1 Change the injector of the burners.

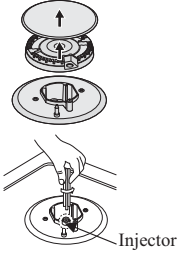

Remove the pan support, Burner lid and Flame spreader.

Unscrew the injector using a 7 mm box spanner and replace it with the stipulated injector for new gas supply. (see Page 26.)

Carefully reassemble the all components.

After injectors are replaced, it is advisable to strongly tighten the injector in place.

2 Adjustment of minimum level of the flame

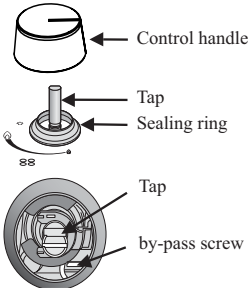

- ① Turn the taps down to minimum.
- ② Remove the control hands from taps.
- ③ Adjusting by pass screw
 - For converting 'natural' gas G20 into 'liquid' gas G30 the screw must be screws down fully tight
 - For converting back from G30 into G20, please rotate the screw in opposite direction to adjust the minimum level
 - Finally check the flame does not go out when quickly turning the tap from the maximum position to the minimum position.
- ④ Install the control handles on the taps.



- Do not dismantle the tap shaft : in the event of a malfunction, change the whole tap.
- Before placing the burners back on the top place, make sure that the injector is not blocked.
- A full operational test and a test for possible leakages must be carried out after gas conversion. (such as soap water or gas detector)
- After completing conversion, a qualified technician or installer has to mark "V" on the right gas category to match with the setting in rating plate. Remove the previous setting "V" mark.

		0359CO1359
		0359-14
Model:	S/N:	
G20/20mbar	220-240V	50/60Hz.Pmax 1W
Σ Qn G20:	G30:	G31:
<input type="checkbox"/> G20/20mbar <input type="checkbox"/> G30/29mbar <input type="checkbox"/> G31/37mbar GB Cat.:II 2H3-		

Appliance Specification

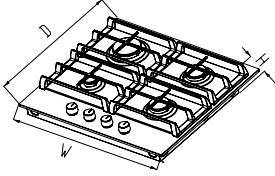
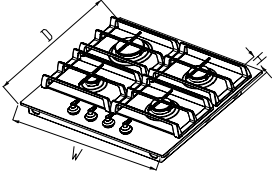
				
Model	NA64H3010AK	NA64H3000AK	NA64H3010CK	NA64H3010CE
Pan Support	Cast Iron			
Wok pan Support	Cast Iron	N/A	Cast Iron	
Top Plate(Glass)	Black Color			Beige Color
Control Handle	Black Color		Copper	
Weight	15.7kg (Include wok)	14.8 kg	15.7kg (Include wok)	15.7kg (Include wok)
Dimension(W*D*H)	600*520*99	600*520*99	600*520*99	600*520*99
Ignition device	Continuous Ignition Type			
Gas Connection	G1/2 thread			
Electric supply	220~240V,50/60Hz			
Burner Feature	Rapid (1), Semi-rapid (2), Auxiliary(1)			
ΣQ_n	8.3kW	8.0kW	8.3kW	8.3kW

Appliance Specification

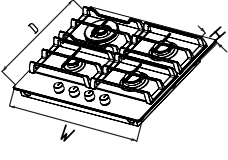
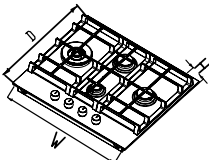
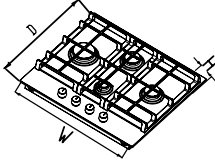
			
Model	NA64H3030AK	NA64H3030BK	NA64H3010BK
Pan Support	Cast Iron		
Wok pan Support	Cast Iron		
Top Plate	Black Color		
Control Handle	Black Color		
Weight	16.6kg (Include wok)	17.2kg (Include wok)	16.3kg (Include wok)
Dimension(W*D*H)	600*520*99	600*520*99	600*520*99
Ignition device	Continuous Ignition Type		
Gas Connection	G1/2 thread		
Electric supply	220~240V,50/60Hz		
Burner Feature	Triple-Crown (1), Semi-rapid (2), Auxiliary (1)		Rapid (1), Semi-rapid (2), Auxiliary(1)
ΣQ_n	8.8kW	8.8kW	8.3kW

Appliance Specification

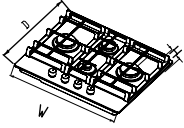
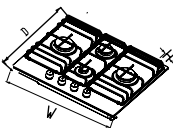
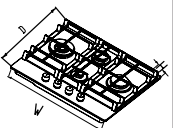
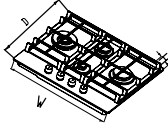
				
Model	NA64H3010BS	NA64H3110BS	NA64H3030BS	NA64H3040BS
Pan Support	Cast Iron	Enamel	Cast Iron	
Wok pan Support	N/A	N/A	Cast Iron	
Top Plate(Glass)	Stainless Steel			
Control Handle	Silver Color			
Weight	11.2kg	9.5kg	12.4kg (Include wok)	
Dimension(W*D*H)	600*510*90	600*510*91	600*510*90	
Ignition device	Continuous Ignition Type			
Gas Connection	G1/2 thread			
Electric supply	220~240V,50/60Hz			
Burner Feature	Rapid (2), Semi-rapid (1), Auxiliary(1)		Triple-Crown(1),Rapid(1), Semi-rapid (1),Auxiliary (1)	
ΣQn	9.6kW	9.6kW	10.1kW	10.3kW

Appliance Specification

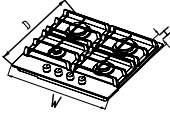
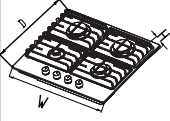
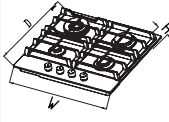
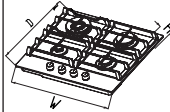
				
Model	NA64H3010AS	NA64H3110AS	NA64H3030AS	NA64H3040AS
Pan Support	Cast Iron	Enamel	Cast Iron	
Wok pan Support	N/A	N/A	Cast Iron	
Top Plate(Glass)	Stainless Steel			
Control Handle	Silver Color			
Weight	10.6kg	9.1kg	11.8kg (Include wok)	
Dimension(W*D*H)	600*510*90	600*510*91	600*510*90	
Ignition device	Continuous Ignition Type			
Gas Connection	G1/2 thread			
Electric supply	220~240V,50/60Hz			
Burner Feature	Rapid (2), Semi-rapid (1), Auxiliary(1)		Triple-Crown(1),Rapid(1), Semi-rapid (1), Auxiliary (1)	
ΣQn	9.6kW	9.6kW	10.1kW	10.3kW

○ **APPLIANCE CLASS : Class 3**

○ **APPLIANCE CATEGORY :**

	BE/FR	GB/IT/PT/LT/ES/CZ/SK	PL/DE
Cat.	II 2E+3+	II 2H3+	II 2E3B/P
P(mbar)	20/25 - 28-30/37	20 - 28-30/37	20/25-37/50
	HU/TR/SK/OR	NL	RU/KA/UKR
Cat.	II 2H3B/P	II 2L3B/P	II 2E3B/P
P(mbar)	25-30	25 - 28-30	13-29

Nominal heat input and rates see below at 15 °C at 1013 mbar

COUNTRY	TYPE OF GAS	BURNER POSITION	Triple-Crown (4.0kW)		Triple-Crown (3.8kW)		Rapid (3.3kW)		Rapid (3.0kW)		Semi-rapid (2.0kW)		Auxiliary (1.0kW)	
			Max	Min	Max	Min	Max	Min	Max	Min	Max	Min	Max	Min
GB, IT, FR, HU, BE, LT, NL, PT, ES, CZ, SK, RU, KZ, UKR, TR	G30 BUTANE 29 mbar	Injector make (1/100mm)	100		99		90		87		70		50	
		Nominal heat input (kW)(Hs)	4.00	1.95	3.80	1.95	3.30	0.81	3.00	0.81	2.00	0.65	1.00	0.41
		Nominal flow rates (g/h)	281	137	267	137	232	57	211	57	137	45	71	29
		Injector make (1/100mm)	100		99		90		87		70		50	
GB, IT, FR, HU, BE, LT, NL, PT, ES, CZ, SK	G31 PROPANE 37 mbar	Nominal heat input (kW)(Hs)	4.00	1.95	3.80	1.95	3.30	0.81	3.00	0.81	2.00	0.65	1.00	0.41
		Nominal flow rates (g/h)	267	130	254	130	221	54	199	54	135	44	68	27
		Injector make (1/100mm)	92		90		83		78		62		46	
		Nominal heat input (kW)(Hs)	4.00	1.95	3.80	1.95	3.30	0.81	3.00	0.81	2.00	0.65	1.00	0.41
DE, NL	G30 BUTANE 50 mbar	Nominal flow rates (g/h)	281	137	267	137	232	57	211	57	137	45	71	29
		Injector make (1/100mm)	92		90		83		78		62		46	
		Nominal heat input (kW)(Hs)	4.00	1.95	3.80	1.95	3.30	0.81	3.00	0.81	2.00	0.65	1.00	0.41
		Nominal flow rates (g/h)	281	137	267	137	232	57	211	57	137	45	71	29
PL	G30 BUTANE 37 mbar	Injector make (1/100mm)	97		93		85		82		66		48	
		Nominal heat input (kW)(Hs)	4.00	1.95	3.80	1.95	3.30	0.81	3.00	0.81	2.00	0.65	1.00	0.41
		Nominal flow rates (g/h)	273	133	259	133	223	55	203	55	143	46	71	29
		Injector make (1/100mm)	145		141		133		130		106		78	
GB, IT, FR, HU, BE, LT, NL, PT, ES, CZ, SK, DE, PL, NL, TR	G20 NATURAL 20 mbar	Nominal heat input (kW)(Hs)	4.00	1.95	3.80	1.95	3.30	0.81	3.00	0.81	2.00	0.65	1.00	0.41
		Nominal flow rates (g/h)	380	185	361	185	314	73	271	73	190	62	91	39
		Injector make (1/100mm)	172		168		150		145		115		85	
		Nominal heat input (kW)(Hs)	4.00	1.95	3.80	1.95	3.30	0.81	3.00	0.81	2.00	0.65	1.00	0.41
RU, KZ, UKR	G20 NATURAL 13 mbar	Nominal flow rates (g/h)	475	230	450	230	390	90	340	90	235	77	113	48
		Injector make (1/100mm)	147		154		138		130		110		79	
		Nominal heat input (kW)(Hs)	4.00	1.95	3.80	1.95	3.30	0.81	3.00	0.81	2.00	0.65	1.00	0.41
		Nominal flow rates (g/h)	443	216	421	216	366	90	332	90	221	72	110	45
NL	G25 NATURAL 25 mbar	Injector make (1/100mm)	147		154		138		130		110		79	
		Nominal heat input (kW)(Hs)	4.00	1.95	3.80	1.95	3.30	0.81	3.00	0.81	2.00	0.65	1.00	0.41
		Nominal flow rates (g/h)	443	216	421	216	366	90	332	90	221	72	110	45
		Injector make (1/100mm)	147		154		138		130		110		79	

BURNER	Calibrated orifice 1/100mm (G30/29mbar)	Calibrated orifice 1/100mm (G30/50mbar)
Auxiliary	29	25
Semi-rapid	34	31
Rapid	43	39
Triple-Crown	68	63

GB: United Kingdom
 IT : Italy
 FR : France
 HU : Hungary
 BE : Belgium
 LT : Lithuania
 NL : Netherlands
 UKR: Ukraine
 TR: Turkish

PT: Portugal
 ES: Spain
 CZ: Czech Republic
 SK: Slovakia
 DE: Germany
 PL: Poland
 RU: Russian
 KZ: Kazakhstan

trouble shooting

- Repairs should be performed by a licensed technician only. Improper repair may result in considerable danger to you and others. If your cooktop needs repair, contact a SAMSUNG Service Centre or your dealer.
- However, some minor problems can be resolved as follows :

Problem	Probable cause	Solution
Not ignited	No Spark.	Check the electricity supply.
	The burner lid is badly assembled.	Assemble the lid correctly.
	The gas supply is closed.	Open the gas supply completely.
Badly ignited	The gas supply is not completely open.	Open the gas supply completely.
	The burner lid is badly assembled.	Assemble the lid correctly.
	The ignition plug is contaminated with alien substance.	Wipe alien substance with a dry cloth .
	The burners are wet.	Dry the burners lids carefully.
	The holes in the flame spreader are clogged.	Clean the flame spreader.
Noise made when combusted and ignited	The burner lid is badly assembled.	Assemble the burner lid correctly.
Flame goes out when in use.	The flame supervision device is contaminated with alien substance.	Clean the flame supervision device.
	Product being cooked has boiled over and extinguished the flame.	Turn off burner knob. Wait one minute and reignite zone.
	A strong draught may have blown the flame out .	Please turn off zone and check cooking area for draught such as open windows. Wait one minute and reignite zone
Yellow Flame	The holes in the flame spreader are clogged.	Clean the flame spreader.
	Different gas is used.	Check the gas used.
Unstable Flame	The burner lid is badly assembled.	Assemble the burner lid correctly.
Gas Smell	Gas leakage	Stop using the product and close the middle valve. Open the window to ventilate. Contact our service centre by using a phone outside.



- If problem is not solved, please contact the Samsung customer care centre.



QUESTIONS OR COMMENTS

COUNTRY	CALL	OR VISIT US ONLINE AT
AUSTRIA	0810-SAMSUNG(7267864, €0.07/min)	www.samsung.com
BELGIUM	02-201-24-18	www.samsung.com/be(Dutch) www.samsung.com/be_fr(french)
DENMARK	70 70 19 70	www.samsung.com
FINLAND	030-6227 515	www.samsung.com
FRANCE	01 48 63 00 00	www.samsung.com/fr
GERMANY	0180 6 SAMSUNG bzw. 0180 6 7267864* [HHP] 0180 6 M SAMSUNG bzw. 0180 6 67267864* (*0,20 €/Anruf aus dem dt. Festnetz, aus dem Mobilfunk max. 0,60 €/Anruf)	www.samsung.com
ITALIA	800-SAMSUNG(726-7864) [HHP] 800.Msamsung (800.67267864)	
CYPRUS	8009 4000 only from landline	
GREECE	80111-SAMSUNG(80111 726 7864) only from land line (+30)210 6897691 from mobile and land line	www.samsung.com/gr
LUXEMBURG	261 03 710	
NETHERLANDS	0900-SAMSUNG(0900-7267864)(€ 0,10/Min)	
NORWAY	815 56480	www.samsung.com
PORTUGAL	808 20-SAMSUNG(808 20 7267)	
SPAIN	902-1-SAMSUNG(902 172 678)	
SWEDEN	0771 726 7864 (SAMSUNG)	
SWITZERLAND	0848- SAMSUNG(7267864, CHF 0.08/Min)	www.samsung.com/ch(German) www.samsung.com/ch_fr(french)
U.K.	0330 SAMSUNG(7267864)	
EIRE	0818 717100	www.samsung.com
POLAND	0 801-172-678* lub +48 22 607-93-33 ** [HHP] 0 801-672-678* lub +48 22 607-93-33** *(całkowity koszt połączenia jak za 1 impuls według taryfy operatora) ** (koszt połączenia według taryfy operatora)	www.samsung.com/pl
ROMANIA	08008 SAMSUNG(08008 726 7864) TOLL FREE No.	www.samsung.com/ro
TURKEY	444 77 11	www.samsung.com
AUSTRALIA	1300 362 603	www.samsung.com/au
RUSSIA	8-800-555-55-55	
GEORGIA	0-800-555-555	
ARMENIA	0-800-05-555	
AZERBAIJAN	088-55-55-555	
KAZAKHSTAN	8-10-800-500-55-500(GSM:7799)	www.samsung.com
UZBEKISTAN	8-10-800-500-55-500	
KYRGYZSTAN	00-800-500-55-500	
TADJIKISTAN	8-10-800-500-55-500	
Mongolia	+7-800-555-55-55	
BELARUS	810-800-500-55-500	
MOLDOVA	0-800-614-40	
UKRAINE	0-800-502-000	www.samsung.com/ua(Ukrainian) www.samsung.com/ua_ru(Russian)