

# USER'S MANUAL

*notebook*





## Notice

The company reserves the right to revise this publication or to change its contents without notice. Information contained herein is for reference only and does not constitute a commitment on the part of the manufacturer or any subsequent vendor. They assume no responsibility or liability for any errors or inaccuracies that may appear in this publication nor are they in anyway responsible for any loss or damage resulting from the use (or misuse) of this publication.

This publication and any accompanying software may not, in whole or in part, be reproduced, translated, transmitted or reduced to any machine readable form without prior consent from the vendor, manufacturer or creators of this publication, except for copies kept by the user for backup purposes.

Brand and product names mentioned in this publication may or may not be copyrights and/or registered trademarks of their respective companies. They are mentioned for identification purposes only and are not intended as an endorsement of that product or its manufacturer.

©August 2010

## Trademarks

**AMD® Athlon™** is a trademark of Advanced Micro Devices, Inc.

## Preface

### **R&TTE Directive**

This device is in compliance with the essential requirements and other relevant provisions of the R&TTE Directive 1999/5/EC.

This device will be sold in the following EEA countries: Austria, Italy, Belgium, Liechtenstein, Denmark, Luxembourg, Finland, Netherlands, France, Norway, Germany, Portugal, Greece, Spain, Iceland, Sweden, Ireland, United Kingdom, Cyprus, Czech Republic, Estonia, Hungary, Latvia, Lithuania, Malta, Slovakia, Poland, Slovenia.

### **CE Marking**

This device has been tested to and conforms to the regulatory requirements of the European Union and has attained CE Marking. The CE Mark is a conformity marking consisting of the letters “CE”. The CE Mark applies to products regulated by certain European health, safety and environmental protection legislation. The CE Mark is obligatory for products it applies to: the manufacturer affixes the marking in order to be allowed to sell his product in the European market.

This product conforms to the essential requirements of the R&TTE directive 1999/5/EC in order to attain CE Marking. A notified body has determined that this device has properly demonstrated that the requirements of the directive have been met and has issued a favorable certificate of expert opinion. As such the device will bear the notified body number 0560 after the CE mark.

The CE Marking is not a quality mark. Foremost, it refers to the safety rather than to the quality of a product. Secondly, CE Marking is mandatory for the product it applies to, whereas most quality markings are voluntary.

## **FCC Statement (Federal Communications Commission)**

You are cautioned that changes or modifications not expressly approved by the party responsible for compliance could void the user's authority to operate the equipment.

This equipment has been tested and found to comply with the limits for a Class B digital device, pursuant to Part 15 of the FCC Rules. These limits are designed to provide reasonable protection against harmful interference in a residential installation. This equipment generates, uses and can radiate radio frequency energy and, if not installed and used in accordance with the instructions, may cause harmful interference to radio communications. However, there is no guarantee that interference will not occur in a particular installation. If this equipment does cause harmful interference to radio or television reception, which can be determined by turning the equipment off and on, the user is encouraged to try to correct the interference by one or more of the following measures:

- Re orient or relocate the receiving antenna.
- Increase the separation between the equipment and receiver.
- Connect the equipment into an outlet on a circuit different from that to which the receiver is connected.
- Consult the service representative or an experienced radio/TV technician for help.

### **Operation is subject to the following two conditions:**

1. This device may not cause interference.  
And
2. This device must accept any interference, including interference that may cause undesired operation of the device.

### FCC RF Radiation Exposure Statement:

1. This Transmitter must not be co-located or operating in conjunction with any other antenna or transmitter.
2. This equipment complies with FCC RF radiation exposure limits set forth for an uncontrolled environment. This equipment should be installed and operated with a minimum distance of 20 centimeters between the radiator and your body.



#### Warning

Use only shielded cables to connect I/O devices to this equipment. You are cautioned that changes or modifications not expressly approved by the manufacturer for compliance with the above standards could void your authority to operate the equipment.

If your purchase option includes both **Wireless LAN** and **3.75G** modules, then the appropriate antennas will be installed. Note that In order to comply with FCC RF exposure compliance requirements, the antenna must not be co-located or operate in conjunction with any other antenna or transmitter.

#### Important Notice - 3.75G/HSPA & Bluetooth/Wireless LAN Modules

In order to comply with FCC regulations you should NOT operate the 3.75G/HSPA module and the Bluetooth/Wireless LAN modules at the same time as this may disrupt radio frequency, and cause interference. When the 3.75G/HSPA module is powered on, make sure that the Bluetooth/Wireless LAN modules are powered off.

## IMPORTANT SAFETY INSTRUCTIONS

Follow basic safety precautions, including those listed below, to reduce the risk of fire, electric shock, and injury to persons when using any electrical equipment:

1. Do not use this product near water, for example near a bath tub, wash bowl, kitchen sink or laundry tub, in a wet basement or near a swimming pool.
2. Avoid using this equipment with a telephone line (other than a cordless type) during an electrical storm. There may be a remote risk of electrical shock from lightning.
3. Do not use the telephone to report a gas leak in the vicinity of the leak.
4. Use only the power cord and batteries indicated in this manual. Do not dispose of batteries in a fire. They may explode. Check with local codes for possible special disposal instructions.
5. This product is intended to be supplied by a Listed Power Unit with an AC Input of 100 - 240V, 50 - 60Hz, DC Output of 19V, 3.42A or 18.5V, 3.5A (65 Watts) minimum AC/DC Adapter.

## CAUTION

**This Computer's Optical Device is a Laser Class 1 Product**

### Instructions for Care and Operation

The notebook computer is quite rugged, but it can be damaged. To prevent this, follow these suggestions:

1. **Don't drop it, or expose it to shock.** If the computer falls, the case and the components could be damaged.





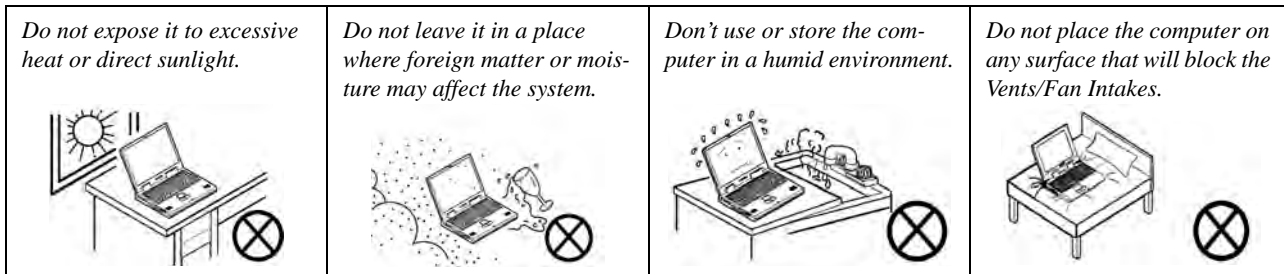

2. **Keep it dry, and don't overheat it.** Keep the computer and power supply away from any kind of heating element. This is an electrical appliance. If water or any other liquid gets into it, the computer could be badly damaged.







3. **Avoid interference.** Keep the computer away from high capacity transformers, electric motors, and other strong magnetic fields. These can hinder proper performance and damage your data.
4. **Follow the proper working procedures for the computer.** Shut the computer down properly and don't forget to save your work. Remember to periodically save your data as data may be lost if the battery is depleted.

<p><i>Do not turn off the power until you properly shut down all programs.</i></p> 	<p><i>Do not turn off any peripheral devices when the computer is on.</i></p> 	<p><i>Do not disassemble the computer by yourself.</i></p> 	<p><i>Perform routine maintenance on your computer.</i></p> 
--	---	---	---

5. **Take care when using peripheral devices.**

<p><i>Use only approved brands of peripherals.</i></p> 	<p><i>Unplug the power cord before attaching peripheral devices.</i></p> 
--	---

### Power Safety

The computer has specific power requirements:



#### Power Safety Warning

Before you undertake any upgrade procedures, make sure that you have turned off the power, and disconnected all peripherals and cables (including telephone lines). It is advisable to also remove your battery in order to prevent accidentally turning the machine on.

- Only use a power adapter approved for use with this computer.
- Your AC/DC adapter may be designed for international travel but it still requires a steady, uninterrupted power supply. If you are unsure of your local power specifications, consult your service representative or local power company.
- The power adapter may have either a 2-prong or a 3-prong grounded plug. The third prong is an important safety feature; do not defeat its purpose. If you do not have access to a compatible outlet, have a qualified electrician install one.
- When you want to unplug the power cord, be sure to disconnect it by the plug head, not by its wire.
- Make sure the socket and any extension cord(s) you use can support the total current load of all the connected devices.
- Before cleaning the computer, make sure it is disconnected from any external power supplies (i.e. AC/DC adapter or car adapter).

*Do not plug in the power cord if you are wet.*



*Do not use the power cord if it is broken.*



*Do not place heavy objects on the power cord.*

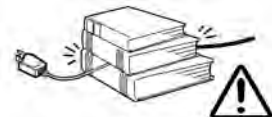

## Polymer Battery Precautions

Note the following information which is specific to polymer batteries only, and where applicable, this overrides the general battery precaution information overleaf.

- Polymer batteries may experience a slight expansion or swelling, however this is part of the battery's safety mechanism and is not a cause for concern.
- Use proper handling procedures when using polymer batteries. Do not use polymer batteries in high ambient temperature environments, and do not store unused batteries for extended periods.

See also the general battery precautionary information overleaf for further information.

### Battery Precautions

- Only use batteries designed for this computer. The wrong battery type may explode, leak or damage the computer.
- Do not remove any batteries from the computer while it is powered on.
- Do not continue to use a battery that has been dropped, or that appears damaged (e.g. bent or twisted) in any way. Even if the computer continues to work with a damaged battery in place, it may cause circuit damage, which may possibly result in fire.
- If you do not use the battery for an extended period, then remove the battery from the computer for storage.
- Recharge the batteries using the notebook's system. Incorrect recharging may make the battery explode.
- Do not try to repair a battery pack. Refer any battery pack repair or replacement to your service representative or qualified service personnel.
- Keep children away from, and promptly dispose of a damaged battery. Always dispose of batteries carefully. Batteries may explode or leak if exposed to fire, or improperly handled or discarded.
- Keep the battery away from metal appliances.
- Affix tape to the battery contacts before disposing of the battery.
- Do not touch the battery contacts with your hands or metal objects.



#### Battery Disposal & Caution

The product that you have purchased contains a rechargeable battery. The battery is recyclable. At the end of its useful life, under various state and local laws, it may be illegal to dispose of this battery into the municipal waste stream. Check with your local solid waste officials for details in your area for recycling options or proper disposal.

Danger of explosion if battery is incorrectly replaced. Replace only with the same or equivalent type recommended by the manufacturer. Discard used battery according to the manufacturer's instructions.

## Cleaning

Do not apply cleaner directly to the computer; use a soft clean cloth.

Do not use volatile (petroleum distillates) or abrasive cleaners on any part of the computer.

## Servicing

Do not attempt to service the computer yourself. Doing so may violate your warranty and expose you and the computer to electric shock. Refer all servicing to authorized service personnel. Unplug the computer from the power supply. Then refer servicing to qualified service personnel under any of the following conditions:

- When the power cord or AC/DC adapter is damaged or frayed.
- If the computer has been exposed to rain or other liquids.
- If the computer does not work normally when you follow the operating instructions.
- If the computer has been dropped or damaged (do not touch the poisonous liquid if the LCD panel breaks).
- If there is an unusual odor, heat or smoke coming from your computer.



### Removal Warning

When removing any cover(s) and screw(s) for the purposes of device upgrade, remember to replace the cover(s) and screw(s) before turning the computer on.

# Travel Considerations

## Packing

As you get ready for your trip, run through this list to make sure the system is ready to go:

1. Check that the battery pack and any spares are fully charged.
2. Power off the computer and peripherals.
3. Close the display panel and make sure it's latched.
4. Disconnect the AC/DC adapter and cables. Stow them in the carrying bag.
5. The AC/DC adapter uses voltages from 100 to 240 volts so you won't need a second voltage adapter. However, check with your travel agent to see if you need any socket adapters.
6. Put the notebook in its carrying bag and secure it with the bag's straps.
7. If you're taking any peripherals (e.g. a printer, mouse or digital camera), pack them and those devices' adapters and/or cables.
8. Anticipate customs - Some jurisdictions may have import restrictions or require proof of ownership for both hardware and software. Make sure your documents are prepared.



### Power Off Before Traveling

Make sure that your notebook is completely powered off before putting it into a travel bag (or any such container). Putting a notebook which is powered on in a travel bag may cause the vent(s)/fan intake(s)/outlet(s) to be blocked. To prevent your computer from overheating make sure nothing blocks the vent(s)/fan intake(s)/outlet(s) while the computer is in use.

## On the Road

In addition to the general safety and maintenance suggestions in this preface, and Chapter 8: Troubleshooting, keep these points in mind:

**Hand-carry the notebook** - For security, don't let it out of your sight. In some areas, computer theft is very common. Don't check it with normal luggage. Baggage handlers may not be sufficiently careful. Avoid knocking the computer against hard objects.

**Beware of Electromagnetic fields** - Devices such as metal detectors & X-ray machines can damage the computer, hard disk, floppy disks, and other media. They may also destroy any stored data - Pass your computer and disks around the devices. Ask security officials to hand-inspect them (you may be asked to turn it on). **Note:** Some airports also scan luggage with these devices.

**Fly safely** - Most airlines have regulations about the use of computers and other electronic devices in flight. These restrictions are for your safety, follow them. If you stow the notebook in an overhead compartment, make sure it's secure. Contents may shift and/or fall out when the compartment is opened.

**Get power where you can** - If an electrical outlet is available, use the AC/DC adapter and keep your battery(ies) charged.

**Keep it dry** - If you move quickly from a cold to a warm location, water vapor can condense inside the computer. Wait a few minutes before turning it on so that any moisture can evaporate.

### Developing Good Work Habits

Developing good work habits is important if you need to work in front of the computer for long periods of time. Improper work habits can result in discomfort or serious injury from repetitive strain to your hands, wrists or other joints. The following are some tips to reduce the strain:



- Adjust the height of the chair and/or desk so that the keyboard is at or slightly below the level of your elbow. Keep your forearms, wrists, and hands in a relaxed position.
- Your knees should be slightly higher than your hips. Place your feet flat on the floor or on a footrest if necessary.
- Use a chair with a back and adjust it to support your lower back comfortably.
- Sit straight so that your knees, hips and elbows form approximately 90-degree angles when you are working.
- Take periodic breaks if you are using the computer for long periods of time.

#### Remember to:

- Alter your posture frequently.
- Stretch and exercise your body several times a day.
- Take periodic breaks when you work at the computer for long periods of time. Frequent and short breaks are better than fewer and longer breaks.





## Lighting

Proper lighting and comfortable display viewing angle can reduce eye strain and muscle fatigue in your neck and shoulders.

- Position the display to avoid glare or reflections from overhead lighting or outside sources of light.
- Keep the display screen clean and set the brightness and contrast to levels that allow you to see the screen clearly.
- Position the display directly in front of you at a comfortable viewing distance.
- Adjust the display-viewing angle to find the best position.

## LCD Screen Care

To prevent **image persistence** on LCD monitors (caused by the continuous display of graphics on the screen for an extended period of time) take the following precautions:

- Set the *Windows* **Power Plans** to turn the screen off after a few minutes of screen idle time.
- Use a rotating, moving or blank screen saver (this prevents an image from being displayed too long).
- Rotate desktop background images every few days.
- Turn the monitor off when the system is not in use.



## Contents

Notice .....	I	Keyboard .....	1-8
FCC Statement .....	III	Function/Hot Key Indicators .....	1-9
FCC RF Radiation Exposure Statement: .....	IV	System Map: Front & Left Views .....	1-10
Instructions for Care and Operation .....	VI	System Map: Right & Rear Views .....	1-11
Power Safety .....	VIII	System Map: Bottom View .....	1-12
Polymer Battery Precautions .....	IX	Video Features .....	1-14
Battery Precautions .....	X	Screen Resolution & ATI Catalyst Control Center .....	1-15
Cleaning .....	XI	Power Options .....	1-16
Servicing .....	XI		
Travel Considerations .....	XII		

## Quick Start Guide

Overview .....	1-1
Advanced Users .....	1-2
Beginners and Not-So-Advanced Users .....	1-2
Warning Boxes .....	1-2
Model Differences .....	1-2
Not Included .....	1-3
System Software .....	1-3
System Startup .....	1-4
System Map: LCD Panel Open .....	1-5
LED Indicators .....	1-6
Hot Key Buttons .....	1-7

## Features & Components

Overview .....	2-1
Hard Disk Drive .....	2-2
Optical (CD/DVD) Device .....	2-3
Loading Discs .....	2-3
Handling CDs or DVDs .....	2-4
DVD Regional Codes .....	2-5
Multi-In-1 Card Reader .....	2-6
TouchPad and Buttons/Mouse .....	2-7
Gestures and Device Settings .....	2-8
Audio Features .....	2-11
Adding a Printer .....	2-13
USB Printer .....	2-13
Parallel Printer .....	2-13

### Power Management

Overview .....	3-1
The Power Sources .....	3-2
AC/DC Adapter .....	3-2
Battery .....	3-2
Turning On the Computer .....	3-3
Power Plans .....	3-4
Power-Saving States .....	3-6
Sleep .....	3-6
Hibernate .....	3-7
Shut down .....	3-7
Configuring the Power Buttons .....	3-8
Resuming Operation .....	3-9
Energy Star Power Saving .....	3-10
Battery Information .....	3-11
Battery Power .....	3-11
Conserving Battery Power .....	3-12
Battery Life .....	3-13
New Battery .....	3-13
Recharging the Battery with the AC/DC Adapter .....	3-13
Proper handling of the Battery Pack .....	3-14
Battery FAQ .....	3-15

### Drivers & Utilities

What to Install .....	4-1
-----------------------	-----

Module Driver Installation .....	4-1
Driver Installation .....	4-2
Updating/Reinstalling Individual Drivers .....	4-4
User Account Control .....	4-4
Windows Security Message .....	4-4
New Hardware Found .....	4-5
Driver Installation Procedure .....	4-5
Video .....	4-5
LAN .....	4-6
TouchPad .....	4-6
CardReader .....	4-6
Hot Key .....	4-6
Audio .....	4-6
AMD AHCI Driver .....	4-7
Windows Experience Index .....	4-8
Optional Drivers .....	4-8
Wireless LAN Module .....	4-9
PC Camera Module .....	4-9
3.75G/HSPA Module .....	4-9

### BIOS Utilities

Overview .....	5-1
The Power-On Self Test (POST) .....	5-2
Failing the POST .....	5-3
Fatal Errors .....	5-3

Non-Fatal Errors .....	5-3
The Setup Utility .....	5-4
Entering Setup .....	5-4
Setup Screens .....	5-5
Main Menu .....	5-6
System Time & Date (Main Menu) .....	5-6
SATA Port 1/2 (Main Menu) .....	5-7
System/Extended Memory (Main Menu) .....	5-7
BIOS Revision/KBC/ EC Firmware Revision (Main Menu) .....	5-7
Advanced Menu .....	5-8
Advanced Chipset Control (Advanced Menu) .....	5-8
SATA Mode Selection (Advanced Menu) .....	5-9
USB BIOS Legacy Support (Advanced Menu) .....	5-9
Boot-time Diagnostic Screen (Advanced Menu) .....	5-9
Power on Boot Beep (Advanced Menu) .....	5-9
Battery Low Alarm Beep (Advanced Menu) .....	5-9
Security Menu .....	5-10
Set Supervisor Password (Security Menu) .....	5-10
Set User Password (Security Menu) .....	5-11
Password on boot: (Security Menu) .....	5-11
Boot Menu .....	5-12
Exit Menu .....	5-13

## Upgrading The Computer

Overview .....	6-1
When Not to Upgrade .....	6-2
Removing the Battery .....	6-3
Upgrading the Hard Disk Drive .....	6-4
Upgrading the Optical (CD/DVD) Device .....	6-7
Upgrading the System Memory (RAM) .....	6-9

## Modules & Options

Overview .....	7-1
Wireless LAN Module .....	7-2
802.11b/g/n Driver Installation .....	7-2
Connecting to a Wireless Network in Windows 7 .....	7-3
Windows Mobility Center .....	7-6
PC Camera Module .....	7-7
PC Camera Driver Installation .....	7-8
3.75G/HSPA Module .....	7-15
Mobile Partner .....	7-19
Mobile Partner Application Installation .....	7-19
Mobile Partner Application .....	7-20
Profile Management .....	7-20
Text Messaging Service .....	7-25
AMD AHCI Driver .....	7-26
Bluetooth Module .....	7-27
Bluetooth Combo Driver Installation .....	7-28

## Preface

Bluetooth & WLAN Combo Settings .....	7-29
Bluetooth Networking Setup .....	7-32
Bluetooth & WLAN Combo Module Configuration ...	7-33
Standard Bluetooth Configuration in Windows 7 .....	7-36

## Troubleshooting

Overview .....	8-1
Basic Hints and Tips .....	8-2
Backup and General Maintenance .....	8-3
Viruses .....	8-4
Upgrading and Adding New Hardware/Software .....	8-5
Problems and Possible Solutions .....	8-7
Uninstalling the AMD AHCI Driver .....	8-12
Bluetooth Connection Problems .....	8-14
Wake On LAN Setup .....	8-18

## Interface (Ports & Jacks)

Overview .....	A-1
Notebook Ports and Jacks .....	A-2

## ATI Video Driver Controls

ATI Video Driver Installation .....	B-1
ATI Catalyst® Control Center .....	B-2
Attaching Other Displays .....	B-4
Display Modes .....	B-5

Configuring an External Display using the ATI CCC ..	B-6
ATI CCC - Switching Display Modes .....	B-7
Configuring an External Display in Win 7 .....	B-9
Theater Mode .....	B-12
PowerPlay™ .....	B-13
HDMI Audio Configuration .....	B-14

## Specifications

Processor .....	C-2
Core Logic .....	C-2
Display .....	C-2
Memory .....	C-2
Video .....	C-2
BIOS .....	C-2
Storage .....	C-2
Audio .....	C-2
Keyboard & Pointing Device .....	C-2
Interface .....	C-3
Card Reader .....	C-3
Slots .....	C-3
Communication .....	C-3
Communication .....	C-3
Power Management .....	C-3
Power .....	C-3
Security .....	C-4

Operating System .....	C-4
Environmental Spec .....	C-4
Dimensions & Weight .....	C-4





# Chapter 1: Quick Start Guide

## Overview

This Quick Start Guide is a brief introduction to the basic features of your computer, to navigating around the computer and to getting your system started. The remainder of the manual covers the following:

- **Chapter 2** A guide to using some of the main features of the computer e.g. the **storage devices (hard disk, optical device, card reader)**, **TouchPad & Mouse**, **Audio & Printer**.
- **Chapter 3** The computer's **power** saving options.
- **Chapter 4** The installation of the **drivers** and utilities essential to the operation or improvement of some of the computer's subsystems.
- **Chapter 5** An outline of the computer's built-in software or **BIOS** (Basic Input Output System).
- **Chapter 6** Instructions for **upgrading** your computer.
- **Chapter 7** A quick guide to the computer's **Wireless LAN**, **PC Camera**, **3.75G/HSPA** and **Bluetooth** modules (some of which may be **optional** depending on your purchase configuration).
- **Chapter 8** A **troubleshooting** guide.
- **Appendix A** Definitions of the **interface**, **ports/jacks** which allow your computer to communicate with external devices.
- **Appendix B** Information on the **ATI Video driver controls**.
- **Appendix C** The computer's **specification**.

## Advanced Users

If you are an advanced user you may skip over most of this Quick Start Guide. However you may find it useful to refer to *“What to Install” on page 4 - 1*, *“BIOS Utilities” on page 5 - 1* and *“Upgrading The Computer” on page 6 - 1* in the remainder of the User’s Manual. You may also find the notes marked with a  of interest to you.

## Beginners and Not-So-Advanced Users



### Notes

Check the light colored boxes with the mark above to find detailed information about the computer’s features.

If you are new to computers (or do not have an advanced knowledge of them) then the information contained in the Quick Start Guide should be enough to get you up and running. Eventually you should try to look through all the documentation (more detailed descriptions of the functions, setup and system controls are covered in the remainder of the User’s Manual), but do not worry if you do not understand everything the first time. Keep this manual nearby and refer to it to learn as you go. You may find it useful to refer to the notes marked with a  as indicated in the margin. For a more detailed description of any of the interface ports and jacks see *“Interface (Ports & Jacks)” on page A - 1*.

## Warning Boxes

No matter what your level please pay careful attention to the warning and safety information indicated by the  symbol. Also please note the safety and handling instructions as indicated in the *Preface*.

## Model Differences

This notebook series includes different model types which differ slightly in design style. Note that your model’s appearance and/or color may appear slightly different from those pictured throughout this manual.

## Not Included

Operating Systems (e.g. *Windows 7*) and applications (e.g. word processing, spreadsheet and database programs) have their own manuals, so please consult the appropriate manuals.

## System Software

Your computer may already come with system software pre-installed. Where this is not the case, or where you are re-configuring your computer for a different system, you will find that this manual refers to the *Windows 7* operating system



### Drivers

If you are installing new system software, or are re-configuring your computer for a different system, you will need to install the drivers listed in ***“Drivers & Utilities” on page 4 - 1***. Drivers are programs which act as an interface between the computer and a hardware component e.g. a wireless network module. It is very important that you install the drivers in the order listed. You will be unable to use most advanced controls until the necessary drivers and utilities are properly installed. If your system hasn't been properly configured (your service representative may have already done that for you); refer to ***Chapter 4*** for installation instructions.

### Ports and Jacks

See ***“Notebook Ports and Jacks” on page A - 2*** for a description of the interface (ports & jacks) which allow your computer to communicate with external devices, connect to the internet etc.

## System Startup

1. Remove all packing materials.
2. Place the computer on a stable surface.
3. Securely attach any peripherals you want to use with the notebook (e.g. keyboard and mouse) to their ports.
4. Attach the AC/DC adapter to the DC-In jack on the left of the computer, then plug the AC power cord into an outlet, and connect the AC power cord to the AC/DC adapter.
5. Use one hand to raise the lid/LCD to a comfortable viewing angle (**do not exceed 130 degrees**); use the other hand (as illustrated in [Figure 1 - 1](#) below) to support the base of the computer (**Note: Never lift the computer by the lid/LCD**).





### Shutdown

Note that you should always shut your computer down by choosing the **Shut Down** command from the bottom right of the **Start** menu in **Windows**. This will help prevent hard disk or system problems.

Figure 1 - 1 - Opening the Lid/LCD & Computer with AC/DC Adapter Plugged-In

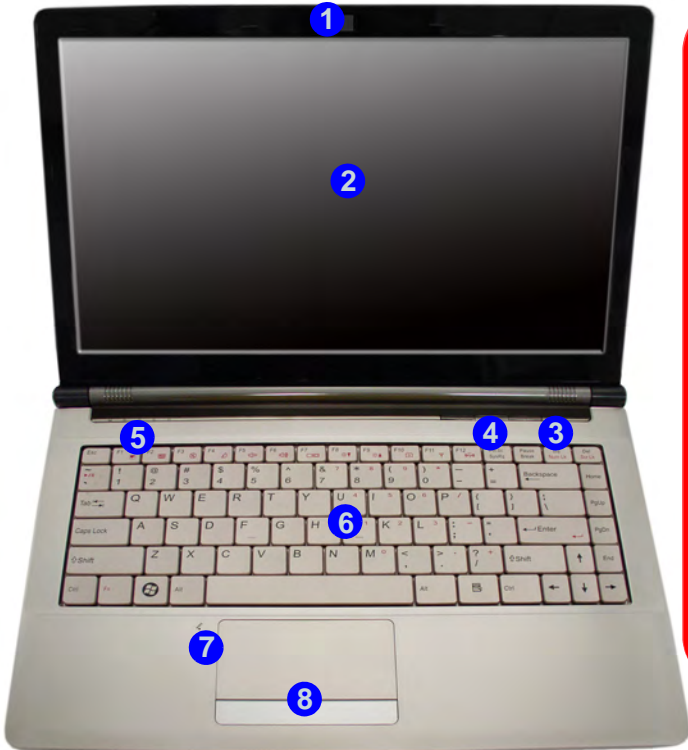
# System Map: LCD Panel Open



  
**Wireless Device  
 Operation Aboard  
 Aircraft**

The use of any portable electronic transmission devices aboard aircraft is usually prohibited. Make sure the module(s) are OFF if you are using the computer aboard aircraft.

Use the key combinations to toggle power to the **3.75G/HSPA/WLAN/Bluetooth** modules, and check the LED indicator or on-screen icon to see if the modules are powered on or not (see [Table 1 - 4, on page 1 - 9](#)/[Table 1 - 1, on page 1 - 6](#)).

Figure 1 - 2  
LCD Panel Open

1. Built-In PC Camera (Optional)
2. LCD
3. Power Button
4. Hot Key Buttons
5. LED Status Indicators (see [Table 1 - 2, on page 1 - 6](#))
6. Keyboard
7. Built-In Microphone
8. Touchpad & Buttons

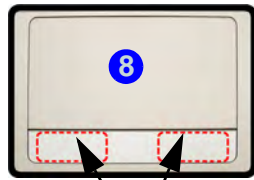

Touchpad Buttons  
(valid operation area)

## LED Indicators

The LED indicators on the computer display helpful information about the current status of the computer.



Icon	Color	Description
		
 <b>1</b>	Orange	DC Power is Plugged In
	Green	The Computer is On
	Blinking Green	The Computer is in Sleep Mode
 <b>2</b>	Orange	The Battery is Charging
	Green	The Battery is Fully Charged
	Blinking Orange	The Battery Has Reached Critically Low Power Status

Table 1 - 1 - LED Power Indicators







Icon	Color	Description
		
 <b>3</b>	Green	Scroll Lock Activated (to activate press Fn & Scr Lk)
 <b>4</b>	Green	Caps Lock Activated
 <b>5</b>	Green	Number Lock Activated
 <b>6</b>	Green	Hard Disk Activity
 <b>7</b>	Green	The <b>(optional)</b> Wireless LAN Module is Powered On
	Orange	The <b>(optional)</b> Bluetooth Module is Powered On

Table 1 - 2 - LED Status Indicators

## Hot Key Buttons

These buttons give instant access to the default Internet browser and e-mail program, and allow you to toggle the **Silent Mode** on/off with one quick button press.





Hot Key	Function
	
	Toggle *Silent Mode (for power saving)
	Activate the Default Internet Program
	Activate the Default E-Mail Browser (Note that in Windows 7 without Outlook/Outlook Express installed this button has no function. If Outlook/Outlook Express are installed then the button will activate the application)

Table 1 - 3 - Hot Key Buttons

\*When enabled, **Silent Mode** will reduce fan noise and save power consumption. Note this may reduce computer performance.

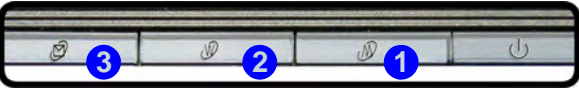

### Other Keyboards

If your keyboard is damaged or you just want to make a change, you can use any standard USB keyboard. The system will detect and enable it automatically. However special functions/hot-keys unique to the system's regular keyboard may not work.

### NumLk & ScrLk

Hold down the **Fn Key** and either **NumLk** or **ScrLk** to enable number or scroll lock, and check the LED indicator for status.

## Keyboard

The keyboard has an embedded numerical keypad for easy numeric data input, and features function keys to allow you to change operational features instantly. See *Table 1 - 4, on page 1 - 9* for full function key combination details.

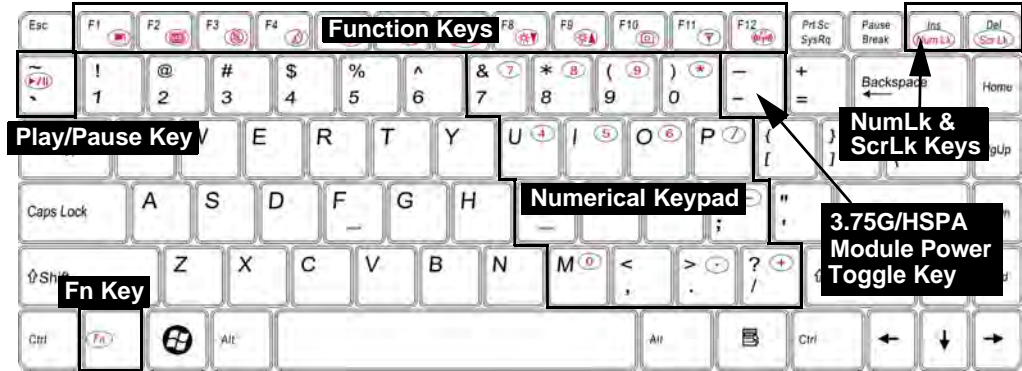

Figure 1 - 3 - Keyboard



### Special Characters

Some software applications allow the number-keys to be used with **Alt** to produce special characters. These special characters can only be produced by using the numeric keypad. Regular number keys (in the upper row of the keyboard) will not work. Make sure that **NumLk** is on.



## Function/Hot Key Indicators

The **function keys** (F1 - F12 etc.) will act as **hot keys** when pressed while the **Fn** key is held down. In addition to the basic function key combinations; visual indicators are available when the hot key utility is installed.





















Keys	Function	Keys	Function
Fn + ~	Play/Pause (in Audio/Video Programs)	Fn + F7	Display Toggle
Fn + 	3.75G Module Power Toggle*  	Fn + F8/F9	Brightness Decrease/Increase  
Fn + F1	TouchPad Toggle  	Fn + F10	PC Camera Power Toggle  
Fn + F2	Turn LCD Backlight Off (Press a key to or use TouchPad to turn on)	Fn + F11	*WLAN Module Power Toggle  
Fn + F3	Mute Toggle  	Fn + F12	Bluetooth Module Power Toggle  
Fn + F4	Sleep Toggle		**Silent Mode Toggle  
Fn + F5/F6	Volume Decrease/Increase  	*Make sure that Wireless is <b>ON</b> in the <b>Windows Mobility Center</b> to ensure proper wireless function key behavior (see page 3 - 12). **When enabled, <b>Silent Mode</b> will reduce fan noise and save power consumption. Note this may reduce computer performance.	

Table 1 - 4 - Function & Hot Key Indicators

## Quick Start Guide

Figure 1 - 4  
Front & Left Views

1. LED Power Indicators (see [Table 1 - 1, on page 1 - 6](#))
2. DC-In Jack
3. External Monitor Port
4. RJ-45 LAN Jack
5. HDMI-Out Port
6. 2 \* USB 2.0 Ports
7. Vent/Fan Intake/Outlet
8. Multi-In-1 Card Reader

\*See [“HDMI Audio Configuration” on page B - 14](#) for more information on the audio settings for **HDMI**.

## System Map: Front & Left Views



### Multi-In-1 Card Reader

The card reader allows you to use the most popular digital storage card formats:

MMC (MultiMedia Card) / RSMC  
SD (Secure Digital) / Mini SD  
MS (Memory Stick) / MS Pro / MS Duo

## System Map: Right & Rear Views



Figure 1 - 5  
Right & Rear Views

1. Microphone-In Jack
2. Headphone-Out Jack
3. USB 2.0 Port
4. Optical Device Drive Bay (for CD/DVD Device)
5. Security Lock Slot
6. Battery



### CD/DVD Emergency Eject

If you need to manually eject a CD/DVD (e.g. due to an unexpected power interruption) you may push the end of a straightened paper clip into the emergency eject hole. Do not use a sharpened pencil or any object that may break and become lodged in the hole. Don't try to remove a floppy disk/CD/DVD while the system is accessing it. This may cause the system to "crash".

### Disk Eject Warning

Don't try to eject a CD/DVD while the system is accessing it. This may cause the system to "crash". Stop the disk first then eject it, or press the stop button twice.

Figure 1 - 6  
Bottom View

## System Map: Bottom View

1. Battery
2. Component Bay Cover
3. Vent/Fan Intake/Outlet
4. Hard Disk Bay Cover
5. 3.75G USIM Card Cover (Optional)
6. Speakers



### CPU

The CPU is not a user serviceable part.

### Overheating

To prevent your computer from overheating make sure nothing blocks the Vent/Fan Intake while the computer is in use.



### Battery Information

Always completely discharge, then fully charge, a new battery before using it. Completely discharge and charge the battery at least once every 30 days or after about 20 partial discharges. See **"Battery" on page 3 - 2** for full instructions.



### Bottom Covers

If your model includes the 3.75G option then a small cover **5** to enable you to access the module's USIM card will be included (see **"3.75G/HSPA Module" on page 7 - 15**).

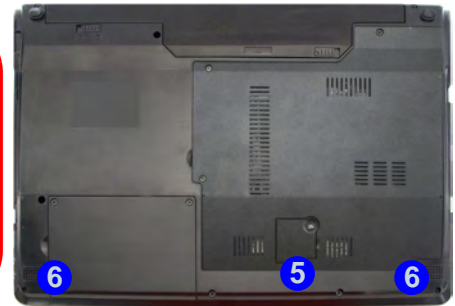
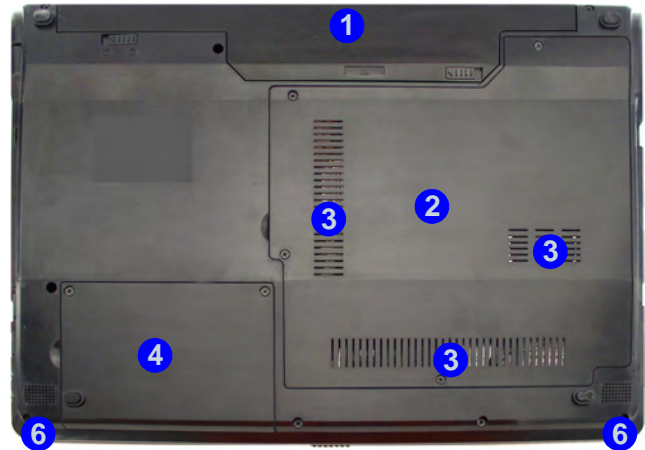

## Windows 7 Start Menu & Control Panel

Most of the control panels, utilities and programs within *Windows 7* (and most other *Windows* versions) are accessed from the **Start** menu. When you install programs and utilities they will be installed on your hard disk drive, and a shortcut will usually be placed in the **Start** menu and/or the desktop. Right-click the **Start** menu icon , and then select **Properties** if you want to customize the appearance of the **Start** menu.

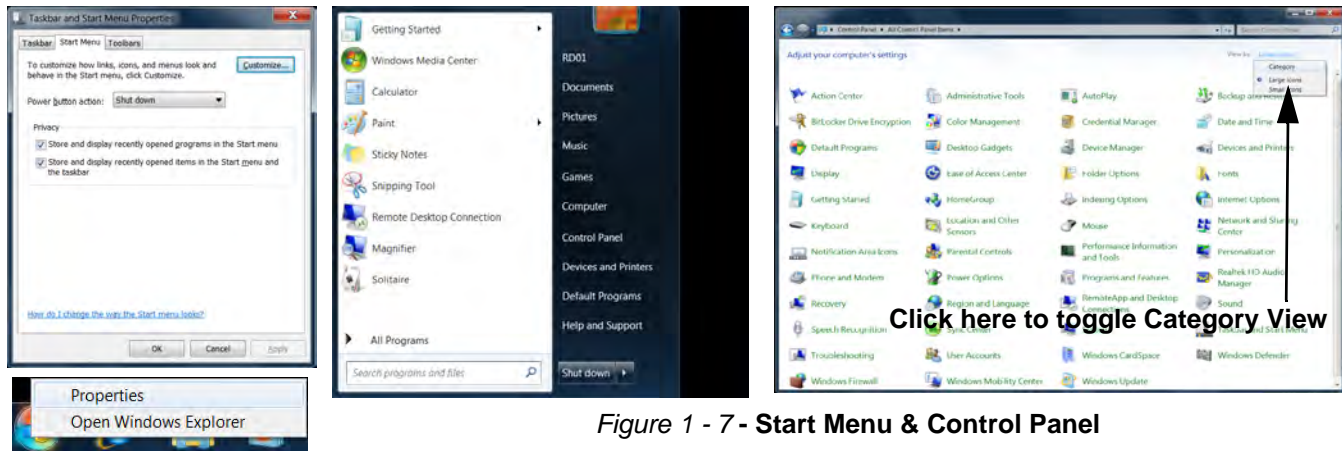

Figure 1 - 7 - Start Menu & Control Panel

In many instances throughout this manual you will see an instruction to open the **Control Panel**. The **Control Panel** is accessed from the **Start** menu, and it allows you to configure the settings for most of the key features in *Windows* (e.g. power, video, network, audio etc.). *Windows 7* provides basic controls for many of the features, however many new controls are added (or existing ones are enhanced) when you install the drivers. To see all controls it may be necessary to toggle off *Category View* to view the control panel icons.

## Video Features

You can configure display options from the **Display** control panel in *Windows*, and from the *ATI Catalyst Control Center* as long as the appropriate **video driver** is installed. For more detailed video information see “*ATI Video Driver Controls*” on page B - 1.

To access **Display (Control Panel) and Screen Resolution** in *Windows*:

1. Click **Start** and click **Control Panel**.
2. Click **Display** (icon) - In the **Appearances and Personalization** category.
3. Click **Adjust Screen Resolution/Adjust resolution**.

OR

4. Alternatively you can right-click the desktop and select **Screen resolution** (see right).
5. Use the dropbox to select the screen **Resolution** ① (*Figure 1 - 8 on page 1 - 15*).
6. Click **Advanced settings** ② (*Figure 1 - 8 on page 1 - 15*) to bring up the **Advanced** properties tabs.

To access the *ATI Catalyst Control Center*:

1. Click **Start** and click **All Programs** (or just click **Start** and select **ATI CCC** ③ *Figure 1 - 8 on page 1 - 15*).
2. Click **Catalyst Control Center**.
3. Click **ATI CCC (Advanced/Wizard)** ④ (*Figure 1 - 8 on page 1 - 15*).

OR

4. Right-click the desktop and select **Catalyst(TM) Control Center**.

OR

5. Double-click the taskbar icon  ⑤ (*Figure 1 - 8 on page 1 - 15*). Note that you can add the ATI icon  to the taskbar (**Enable System Tray Menu**) from the Catalyst Control Center's **Options > Preferences** menu ⑥.

# Screen Resolution & ATI Catalyst Control Center

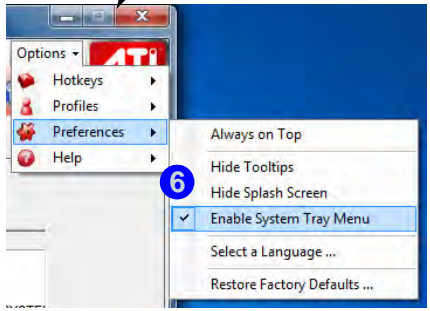
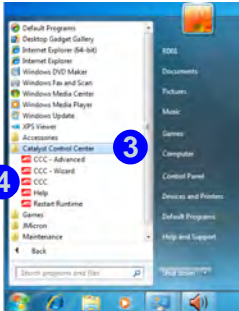
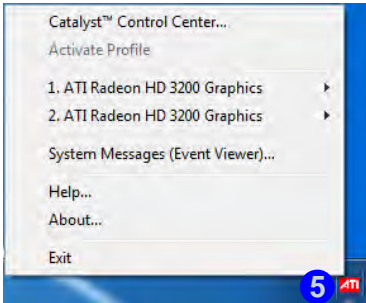
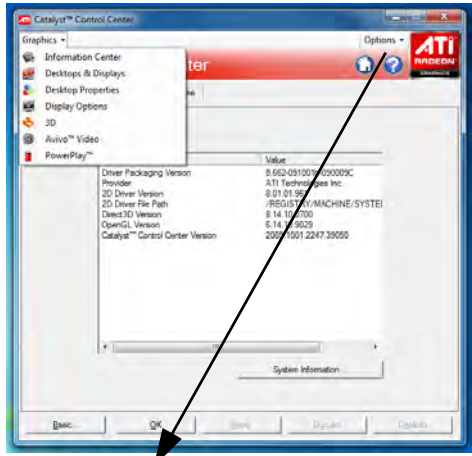
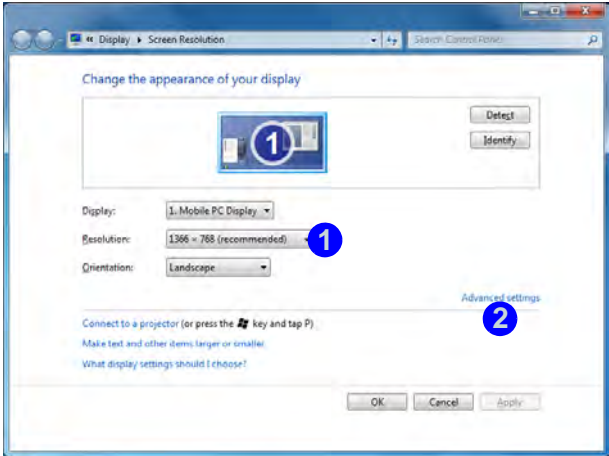

Figure 1 - 8 - Screen Resolution & ATI Controls



## Power Options

The **Power Options (Hardware and Sound menu)** control panel icon in *Windows* (see page *1 - 12*) allows you to configure power management features for your computer. You can conserve power by means of **power plans** and configure the options for the **power button, sleep button, computer lid (when closed), display and sleep mode** from the left menu. Note that the **Power saver** plan may have an affect on computer performance.

Click to select one of the existing plans, or click *Create a power plan* in the left menu and select the options to create a new plan. Click *Change plan settings* and click *Change advanced power settings* to access further configuration options.

Pay attention to the instructions on battery care in *“Battery” on page 3 - 2*.

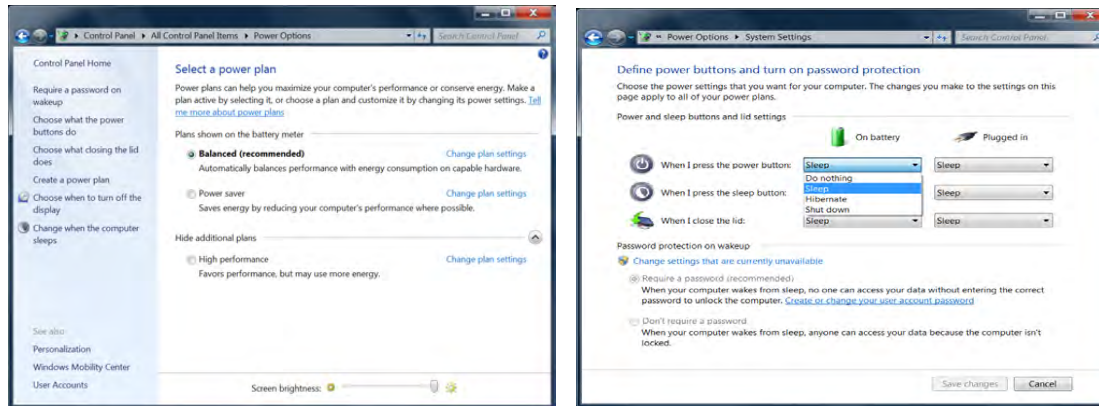

Figure 1 - 9 - Power Options



# Chapter 2: Features & Components

## Overview

Read this chapter to learn more about the following main features and components of the computer:

- Hard Disk Drive
- Optical (CD/DVD) Device
- Multi-In-1 Card Reader
- TouchPad and Buttons/Mouse
- Audio Features
- Adding a Printer



### Power Safety

Before attempting to access any of the internal components of your computer please ensure that the machine is not connected to the AC power, and that the machine is turned off. Also ensure that all peripheral cables, including phone lines, are disconnected from the computer.

## Hard Disk Drive

The hard disk drive is used to store your data in the computer. The hard disk can be taken out to accommodate other 2.5" serial (SATA) hard disk drives (see [“Storage” on page C - 2](#)) with a height of 9.5 mm.

The hard disk is accessible from the bottom of your computer as seen below. For further details see [“Upgrading the Hard Disk Drive” on page 6 - 4](#).

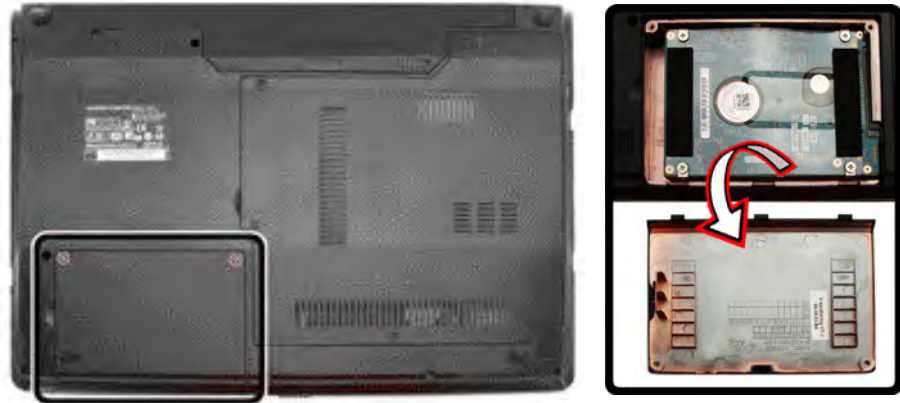

*Figure 2 - 1*

**Hard Disk Location**

## Optical (CD/DVD) Device

There is a bay for a 5.25" optical (CD/DVD) device (12.7mm height). The actual device will depend on the module you purchased (see *“Storage” on page C - 2*). The optical device is usually labeled **“Drive D:”** and may be used as a boot device if properly set in the **BIOS** (see *“Boot Menu” on page 5 - 12*).

### Loading Discs

To insert a CD/DVD, press the open button **1** and carefully place a CD/DVD onto the disc tray with label-side facing up (use just enough force for the disc to click onto the tray’s spindle). Gently push the CD/DVD tray in until its lock “clicks” and you are ready to start. The busy indicator **2** will light up while data is being accessed, or while an audio/video CD, or DVD, is playing. If power is unexpectedly interrupted, insert an object such as a straightened paper clip into the emergency eject hole **3** to open the tray.



### Sound Volume Adjustment

How high the sound volume can be set depends on the setting of the volume control within **Windows**. Click the **Volume** icon on the taskbar to check the setting (see *“Audio Features” on page 2 - 11*).

*Figure 2 - 2*  
Optical Device



### CD Emergency Eject

If you need to manually eject a CD (e.g. due to an unexpected power interruption) you may push the end of a straightened paper clip into the emergency eject hole. However please do NOT use a sharpened pencil or similar object that may break and become lodged in the hole.

### Disk Eject Warning

Don't try to remove a CD/DVD while the system is accessing it. This may cause the system to "crash".

## Handling CDs or DVDs

Proper handling of your CDs/DVDs will prevent them from being damaged. Please follow the advice below to make sure that the data stored on your CDs/DVDs can be accessed.

Note the following:

- Hold the CD or DVD by the edges; do not touch the surface of the disc.
- Use a clean, soft, dry cloth to remove dust or fingerprints.
- Do not write on the surface with a pen.
- Do not attach paper or other materials to the surface of the disc.
- Do not store or place the CD or DVD in high-temperature areas.
- Do not use benzene, thinner, or other cleaners to clean the CD or DVD.
- Do not bend the CD or DVD.
- Do not drop or subject the CD or DVD to shock.

## DVD Regional Codes

To change the DVD regional codes:

1. Go to the **Control Panel**
2. Double-click **Device Manager (Hardware and Sound)**, then click the **+** next to **DVD/CD-ROM drives**.
3. Double-click on the DVD-ROM device to bring up the **Properties** dialog box, and select the **DVD Region** (tab) to bring up the control panel to allow you to adjust the regional code.
4. DVD region detection is device dependent, not OS-dependent. You can select your module's region code **5** times. The fifth selection is permanent. This cannot be altered even if you change your operating system or you use the module in another computer.

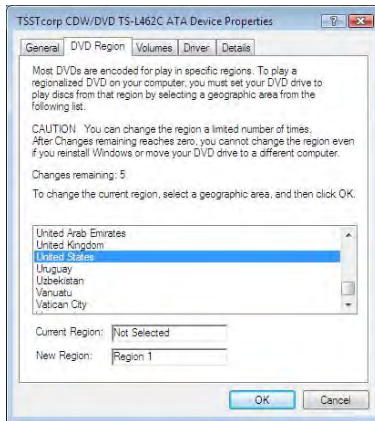

- **Region 1** - USA & Canada
- **Region 2** - Western Europe, Japan, South Africa, Middle East & Egypt
- **Region 3** - South-East Asia, Taiwan, South Korea, The Philippines, Indonesia, Hong Kong
- **Region 4** - South & Central America, Mexico, Australia, New Zealand
- **Region 5** - N Korea, Russia, Eastern Europe, India & Most of Africa
- **Region 6** - China

*Figure 2 - 3*  
**DVD Region Codes**



### Card Reader Cover

Make sure you keep the rubber cover provided in the card reader when not in use. This will help prevent foreign objects and/or dust getting in to the card reader.

## Multi-In-1 Card Reader

The card reader allows you to use some of the latest digital storage cards. Push the card into the slot and it will appear as a removable device, and can be accessed in the same way as your hard disk (s). Make sure you install the Card Reader driver (see *“CardReader” on page 4 - 6*).

- MMC (MultiMedia Card) / RSMMC
- SD (Secure Digital) / Mini SD
- MS (Memory Stick) / MS Pro / MS Duo

**\*Note:** The PC adapters are usually supplied with these cards.

*Figure 2 - 4*  
**Left View**

1. Card Reader



## TouchPad and Buttons/Mouse

The TouchPad is an alternative to the mouse; however, you can also add a mouse to your computer through one of the USB ports. The TouchPad buttons function in much the same way as a two-button mouse.

Once you have installed the TouchPad driver (see *“TouchPad” on page 4 - 6*) you can configure the functions by double-clicking the TouchPad driver icon  on the **taskbar**. You may then configure the TouchPad tapping, buttons, scrolling, pointer motion and sensitivity options to your preferences. You will find further information at [www.synaptics.com](http://www.synaptics.com).

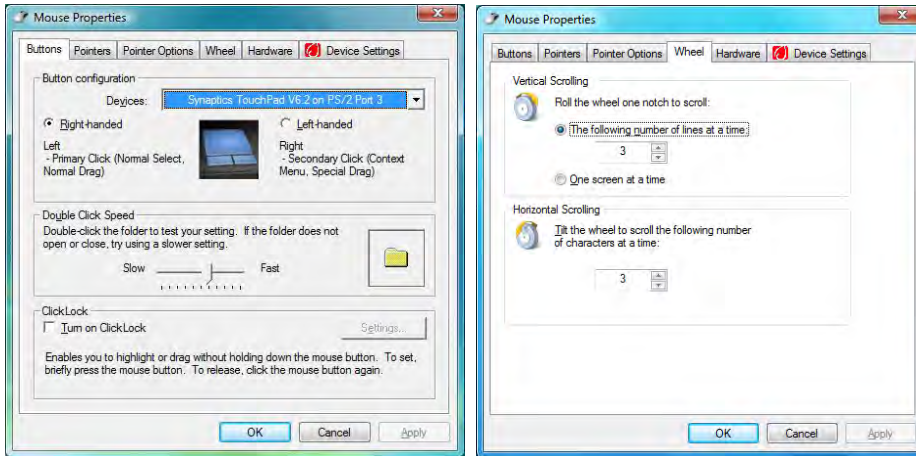

### Mouse Driver

If you are using an external mouse your operating system may be able to auto-configure your mouse during its installation or only enable its basic functions. Be sure to check the device's user documentation for details.

*Figure 2 - 5*  
**Mouse Properties**



### Show Video

You can get a clearer view of the gestures involved by clicking the **Show Video** option for each gesture item.

Select the gesture (**Pinch Zoom**, **Rotating**, **Three Fingers Down** and **Three Finger Flick**) in the **Device Settings > Settings** left tree menu and click the **Show Video** button to see the demonstration video.

For more details on any of the gestures see the **help** in the lower part of the right menu window.

*Figure 2 - 6*  
**Mouse Properties -  
Device Settings**

## Gestures and Device Settings

The Synaptics Gestures Suite application allows you to use a specific gesture (action) on the surface of the TouchPad to perform specific actions to manipulate documents, objects and applications.

You can configure the settings from the Device Settings tab in **Mouse Properties**:

1. Click **Start**, and click **Control Panel** (or point to **Settings** and click **Control Panel**).
2. Click **Mouse (Hardware and Sound)**.
3. Click **Device Settings** (tab) and click **Settings**.
4. Use the menu tree on the left to access the user configurable settings.

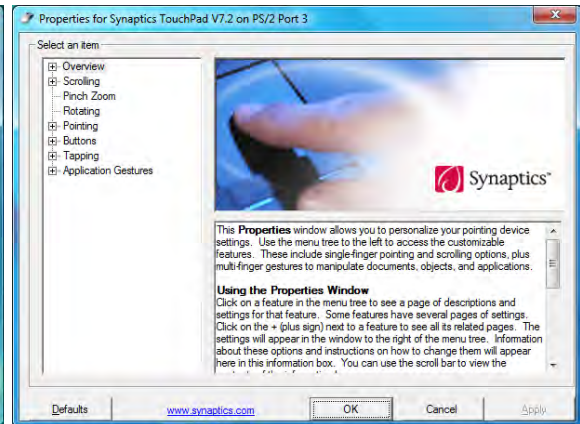
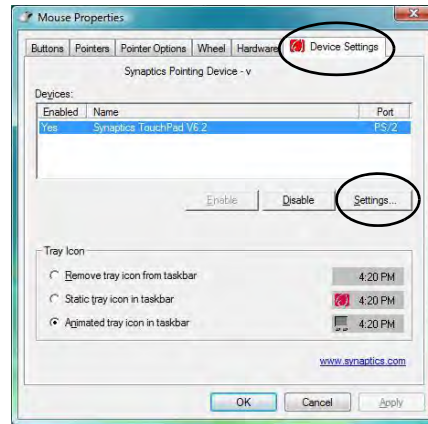



## Scrolling

The Two-Finger scrolling feature works in most scrollable windows and allows you to scroll horizontally and vertically. Place two fingers, slightly separated, on the TouchPad surface and slide both fingers in the direction required (in a straight continuous motion).



*Figure 2 - 7*  
**Scrolling Gesture**

## Zooming

The Pinch Zoom gesture can be used to perform the same function as a scroll wheel in *Windows* applications that support CTRL + scroll wheel zoom functionality. Place two fingers on the TouchPad (for best results use the tips of the fingers) and slide them apart to zoom in, or closer together to zoom out.



*Figure 2 - 8*  
**Zooming Gesture**

### Rotating

Use the Pivot Rotate gesture to rotate objects (e.g. photos) in 90 degree increments. Place a finger down on the left “target” zone and keep it stationary. Place another finger near the middle of the TouchPad and slide it in a circular motion around the stationary finger (clockwise or counterclockwise) to rotate the object.

*Figure 2 - 9*  
**Rotating Gesture**





### Three Finger-Flick/Three Fingers Down (Press)

The Three Finger-Flick gesture may be used to enhance navigation with a variety of applications such as browsing the Internet or scrolling through a photo viewer. The Three Fingers Down gesture may be used to launch user-selectable applications.

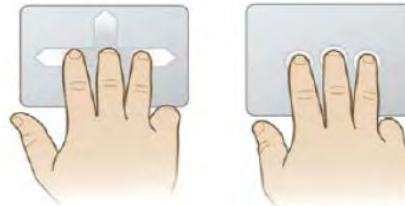
*Figure 2 - 10*  
**Flick/Press  
Gesture**



## Audio Features

You can configure the audio options on your computer from the **Sound**  control panel in *Windows*, from the **HD VDeck** icon on the desktop  or **VIA HD Audio Deck** control panel  [VIA HD Audio Deck](#) .

The volume may also be adjusted by means of the **Fn + F5/F6** key combination.

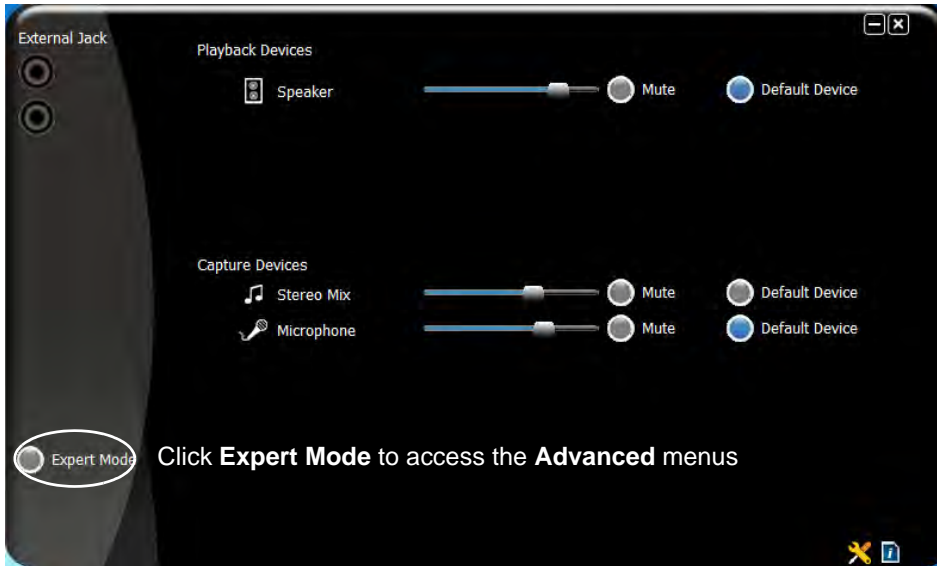

### Sound Volume Adjustment

The sound volume level is set using the volume control within *Windows* (and the volume function keys on the computer). Click the volume icon in the taskbar to check the setting.



Figure 2 - 11  
VIA HD Audio Deck

**Expert Mode** will allow you to access more advanced configuration menus.

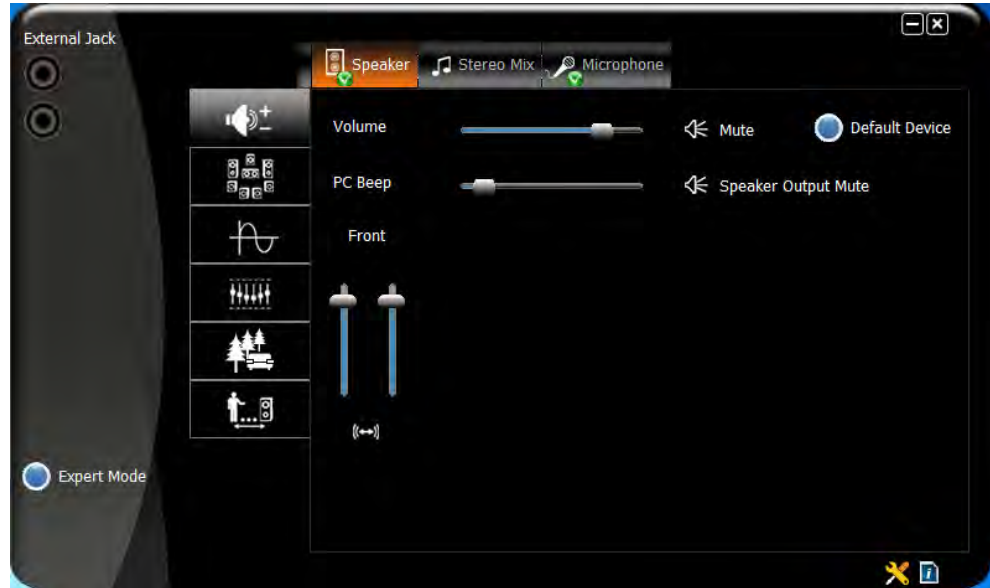

*Figure 2 - 12*  
VIA HD Audio Deck  
(Expert Mode)

See ***“HDMI Audio Configuration”*** on page ***B - 14*** for more information on the audio settings for HDMI.

## Adding a Printer

The most commonly used peripheral is a printer. The following conventions will help you to add a printer; however it is always best to refer to the printer manual for specific instructions and configuration options.

### USB Printer

Most current printers have a USB interface connection. You may use any one of the ports to connect the printer.

#### Install Instructions:

1. Set up the printer according to its instructions (unpacking, paper tray, toner/ink cartridge etc.).
2. Turn ON the computer.
3. Turn ON the printer.
4. Connect the printer's USB cable to one of the USB ports on the computer.
5. **Windows** will identify the printer and either load one of its own drivers or ask you to supply one. Follow the on-screen instructions.

### Parallel Printer

This is still a very common type of printer. The install instructions are in the sidebar, however you will need to purchase a parallel to USB converter.



#### Parallel Printer

After setting up the printer attach the parallel cable to the printer.

Connect the printer's parallel cable to the Parallel to USB converter, and then plug the converter into the USB port.

Turn ON the printer, then turn ON the computer.

*Windows* will identify the printer and either load one of its own drivers or ask you to supply one. Follow the on-screen instructions.



# Chapter 3: Power Management

## Overview

To conserve power, especially when using the battery, your computer power management conserves power by controlling individual components of the computer (the monitor and hard disk drive) or the whole system. This chapter covers:

- The Power Sources
- Turning On the Computer
- Power Plans
- Power-Saving States
- Configuring the Power Buttons
- Battery Information

The computer uses enhanced power saving techniques to give the operating system (OS) direct control over the power and thermal states of devices and processors. For example, this enables the OS to set devices into low-power states based on user settings and information from applications.



### OS Note

Power management functions will vary slightly depending on your operating system. For more information it is best to refer to the user's manual of your operating system.



### Wake On LAN

If you need your system setup to Wake ON LAN, then see the instructions in [“Wake On LAN Set-up” on page 8 - 18.](#)

## The Power Sources

The computer can be powered by either an AC/DC adapter or a battery pack.

### AC/DC Adapter

Use only the AC/DC adapter that comes with your computer. The wrong type of AC/DC adapter will damage the computer and its components.

1. Attach the AC/DC adapter to the DC-in jack on the left of the computer.
2. Plug the AC power cord into an outlet, and then connect the AC power cord to the AC/DC adapter.
3. Raise the lid/LCD to a comfortable viewing angle.
4. Press the power button to turn “On”.

### Battery

The battery allows you to use your computer while you are on the road or when an electrical outlet is unavailable. Battery life varies depending on the applications and the configuration you're using. **To increase battery life, let the battery discharge completely before recharging** (see [“How do I completely discharge the battery?” on page 3 - 15.](#))

We recommend that you do not remove the battery. For more information on the battery, please refer to [“Battery Information” on page 3 - 11.](#)



# Turning On the Computer

Now you are ready to begin using your computer. To turn it on simply press the power button on the front panel.

When the computer is on, you can use the power button as a Stand by/Hibernate/Shutdown hot-key button when it is pressed for less than **4 seconds** (pressing and holding the power button for longer than this will shut the computer down). Use **Power Options** in the *Windows* control panel to configure this feature.

  
**Shut Down**

Note that you should always shut your computer down by choosing the **Shut Down** command from the bottom right of the **Start** menu in *Windows*. This will help prevent hard disk or system problems.

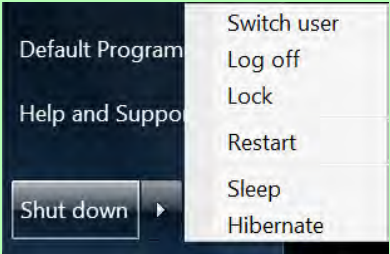

  
**Forced Off**

If the system “hangs”, and the **Ctrl + Alt + Del** key combination doesn’t work, press the power button for **4 seconds**, or longer, to force the system to turn itself off.

**Power Button as Stand by or Hibernate Button**

You can use the OS’s “Power Options” control panel to set the power button to send the system into Stand by or Hibernate mode (see your OS’s documentation, or *“Configuring the Power Buttons” on page 3 - 8* for details).



### Resuming Operation

See [Table 3 - 1](#), on [page 3 - 9](#) for information on how to resume from a power-saving state.

### Password

It is recommended that you enable a password on system resume in order to protect your data.

## Power Plans

The computer can be configured to conserve power by means of **power plans**. You can use (or modify) an existing **power plan**, or create a new one.

The settings may be adjusted to set the **display** to turn off after a specified time, and to send the computer into **Sleep** after a period of inactivity.

Click *Change plan settings* and then click *Change advanced power settings* to access further configuration options in **Advanced Settings**.

*Figure 3 - 1*  
**Power Plan  
Advanced Settings**

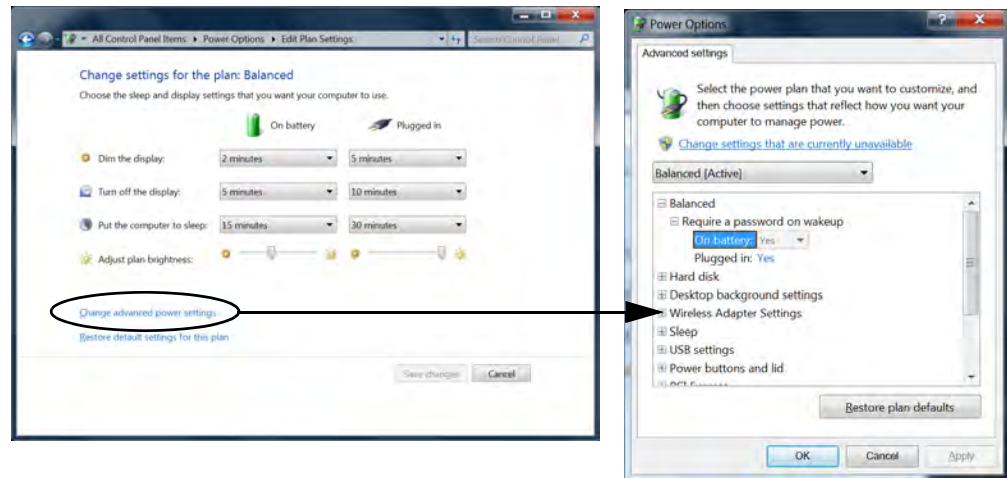

Each **Windows power plan** will also adjust the processor performance of your machine in order to save power. This is worth bearing in mind if you are experiencing any reduced performance (especially under DC/battery power).

Choose **High performance** (you may need to click **Show additional plans** to view the High performance plan) for maximum performance when the computer is powered from an AC power source. Choose the **Power saver** (bear in mind that this scheme may slow down the overall performance of the computer in order to save power) for maximum power saving when the computer is battery (DC power) powered.

Click to Show/Hide additional power plans

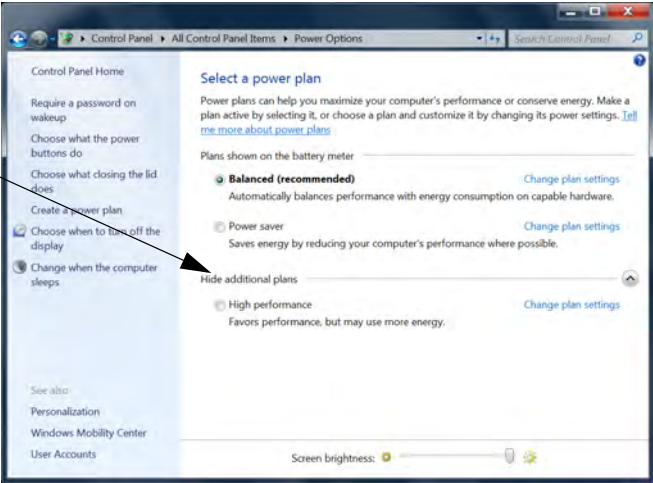

Figure 3 - 2 Power Plans

# Power-Saving States

You can use power-saving states to stop the computer's operation and restart where you left off. *Win 7* uses the **Sleep**, **Hibernate** and **Shut Down** power-saving states.

## Sleep

In **Sleep** all of your work, settings and preferences are saved to memory before the system sleeps. When you are not using your computer for a certain length of time, which you specify in the operating system, it will enter **Sleep** to save power.

The PC wakes from **Sleep within seconds** and will return you to where you last left off (what was on your desktop) without reopening the application(s) and file(s) you last used.

If your mobile PC in **Sleep** is running on battery power the system will use only a minimum amount of power. After an extended period the system will save all the information to the hard disk and shut the computer down before the battery becomes depleted.

### Hibernate

**Hibernate** uses the least amount of power of all the power-saving states and saves all of your information on a part of the hard disk before it turns the system off. If a power failure occurs the system can restore your work from the hard disk; if a power failure occurs when work is saved only to memory, then the work will be lost. **Hibernate** will also return you to where you last left off within seconds. You should put your mobile PC into **Hibernate** if you will not use the computer for a period of time, and will not have the chance to charge the battery.

### Shut down

You should **Shut down** the computer if you plan to install new hardware (don't forget to remove the battery and follow all the safety instructions in **Chapter 6**), plan to be away from the computer for several days, or you do not need it to wake up and run a scheduled task. Returning to full operation from **Shut down** takes longer than from **Sleep** or **Hibernate**.

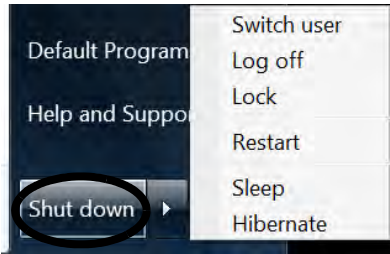

*Figure 3 - 3*  
**Start Menu Power**



### Password Protection

It is recommended that you enable a password on wake up in order to protect your data.

However you can disable this setting from the **Power Options** menu by clicking **Require a password on wakeup** in the left menu, and selecting the options (click **Change settings that are currently unavailable**).

*Figure 3 - 4*  
**Power Options**  
**Define Power**  
**Buttons**

## Configuring the Power Buttons

The power/sleep button (**Fn + F4** key combo) and closed lid may be set to send the computer in to a power-saving state. Click **Choose what the power buttons do** on the left menu in **Power Options** to bring up the menu.

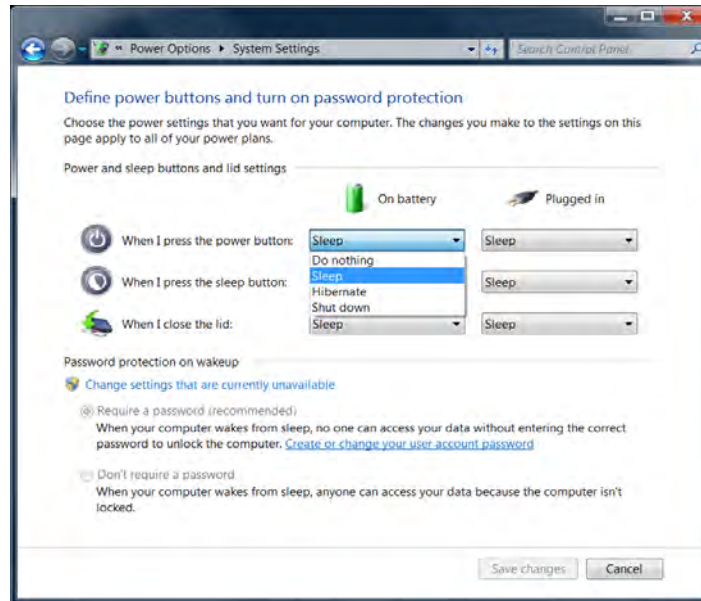

### Resuming Operation

You can resume operation from power-saving states by pressing the power button, or in some cases pressing the sleep button (**Fn + F4** key combo).

Power Status	Icon  Color	To Resume
Power Off	Off	Press the Power Button
Sleep	Blinking Green	Press the Power Button Press the Sleep Button (Fn + F4 Key Combo)
Hibernate	Off (battery) Orange (AC/DC adapter)	Press the Power Button
Display Turned Off	Green	Press a Key or Move the Mouse/Touchpad



**Power Button**

When the computer is on, you can use the power button as a Sleep/Hibernate/Shut Down hot key button when it is pressed for less than **4 seconds** (pressing and holding the power button for longer than this will force the computer to shut down).



**Closing the Lid**

If you have chosen to send the computer to **Sleep** when the lid is closed, raising the lid will wake the system up.

*Table 3 - 1 Resuming Operation*



**3.75G/HSPA Modules & System Wake Up**

Note that the 3.75G modules **DO NOT** support system wake up on 3.75G/HSPA modem activity.



### Taskbar Icon

If the taskbar icon does not appear then click the taskbar arrow and select **Customize**.

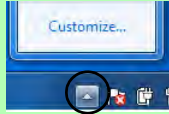



Select **Show icon and notifications** alongside the **Hotkey** icon and click **OK**. The  icon will now appear in the taskbar.

Figure 3 - 5  
Energy Star Menu

## Energy Star Power Saving

This system supports **Energy Star** power management features that place computers (CPU, hard drive, etc.) into a low-power sleep modes after a designated period of inactivity. If you want to enable Energy Star power saving then follow these instructions:

1. Right-click the taskbar icon  (see sidebar).
2. Select **Power Conservation Modes**. 
3. Select **Energy Star** to use the Energy Star power management and override other power saving settings.



### Conservation Modes

The default **Energy Star** setting will result in maximum power saving, but with the possible loss of some performance.

Setting the mode to **Balance** will give power saving matched with performance.

**Performance** will give optimum computer performance but with less power conservation.





# Battery Information

Follow these simple guidelines to get the best use out of your battery.

## Battery Power

Your computer's battery power is dependent upon many factors, including the programs you are running, and peripheral devices attached. You can set actions to be taken (e.g. Shut down, Hibernate etc.), and set critical and low battery levels from power plan **Change plan settings > Change advanced power settings** (see *Figure 3 - 2 on page 3 - 5*).

Click the battery icon  in the taskbar to see the current battery level and charge status.



**Low Battery Warning**

When the battery is critically low, immediately connect the AC/DC adapter to the computer or save your work, otherwise, the unsaved data will be lost when the power is depleted.

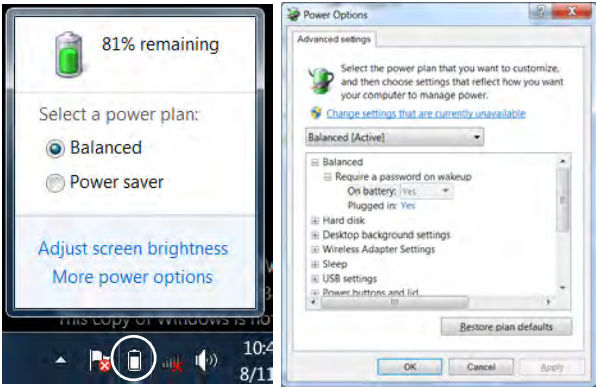

*Figure 3 - 6*  
**Battery Icon (Taskbar) & Battery Advanced Settings**



### Wireless Hot Keys

The computer's wireless function keys will not function properly if **Wireless** is turned **OFF** in the **Windows Mobility Center** control panel.

The wireless indicators  may show that the WLAN module is powered on, however if wireless is OFF in the Mobility Center, the module will not be powered on.

Make sure that Wireless is **ON** in the Mobility Center to ensure proper function key behavior.

*Figure 3 - 7*  
**Windows Mobility Center**

## Conserving Battery Power

- Use a **power plan** that conserves power (e.g **Power saver**), however note that this may have an affect on computer performance.
- Lower the brightness level of the LCD display. The system will decrease LCD brightness slightly to save power when it is not powered by the AC/DC adapter.
- Reduce the amount of time before the display is turned off.
- Close wireless, Bluetooth, modem or communication applications when they are not being used.
- Disconnect/remove any unnecessary external devices e.g. USB devices, ExpressCards etc.

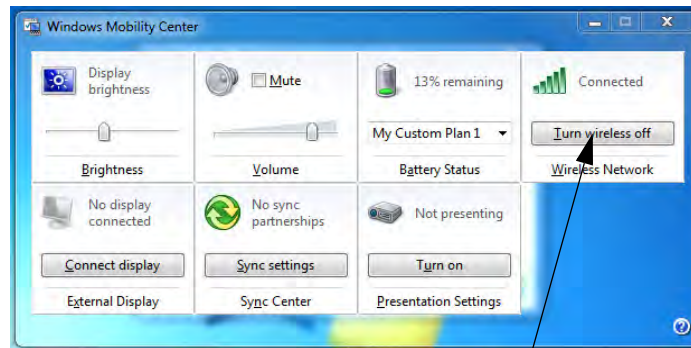

Make sure Wireless is ON to ensure proper function key behavior.



### Windows Mobility Center

The **Windows Mobility Center** control panel provides an easy point of access for information on battery status, power plans used and wireless device status etc.

## Battery Life

Battery life may be shortened through improper maintenance. **To optimize the life and improve its performance, fully discharge and recharge the battery at least once every 30 days.**

We recommend that you do not remove the battery yourself. If you do need to remove the battery for any reason (e.g. long term storage) see *“Removing the Battery” on page 6 - 3.*

## New Battery

Always completely discharge, then fully charge, a new battery (see *“Battery FAQ” on page 3 - 15* for instructions on how to do this).

## Recharging the Battery with the AC/DC Adapter

The battery pack automatically recharges when the AC/DC adapter is attached and plugged into an electrical outlet. If the computer is powered on, and in use, it will take several hours to fully recharge the battery. When the computer is turned off but plugged into an electrical outlet, battery charge time is less. (Refer to *“LED Indicators” on page 1 - 6* for information on the battery charge status, and to *“Energy Star Power Saving” on page 3 - 10* for more information on how to maintain and properly recharge the battery pack.)



### Caution

Danger of explosion if battery is incorrectly replaced.

Replace only with the same or equivalent type recommended by the manufacturer. Discard used battery according to the manufacturer's instructions.

### Proper handling of the Battery Pack

- DO NOT disassemble the battery pack under any circumstances
- DO NOT expose the battery to fire or high temperatures, it may explode
- DO NOT connect the metal terminals (+, -) to each other



### Damaged Battery Warning

Should you notice any physical defects (e.g. the battery is bent out of shape after being dropped), or any unusual smells emanating from the notebook battery, shut your computer down immediately and contact your service center. If the battery has been dropped we do not recommend using it any further, as even if the computer continues to work with a damaged battery in place, it may cause circuit damage, which may possibly result in fire. It is recommended that you replace your computer battery every two years.

## Battery FAQ

### How do I completely discharge the battery?

Use the computer with battery power until it shuts down due to a low battery. Don't turn off the computer even if a message indicates the battery is critically low, just let the computer use up all of the battery power and shut down on its own.

1. Save and close all files and applications.
2. **Create a power plan** for discharging the battery and set all the options to **Never**.

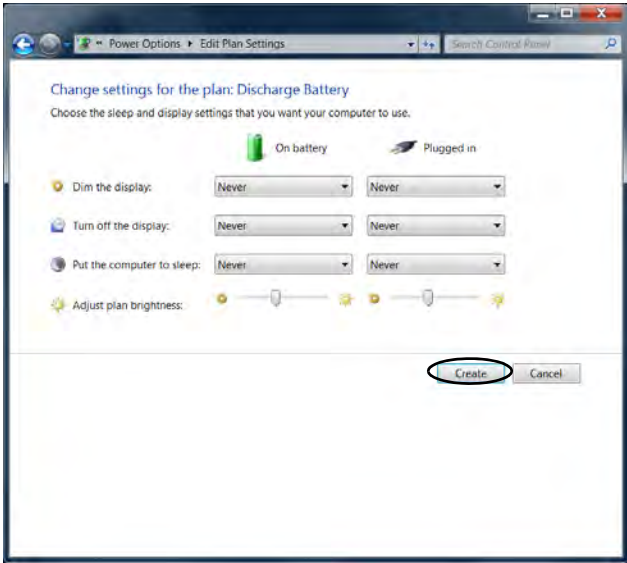
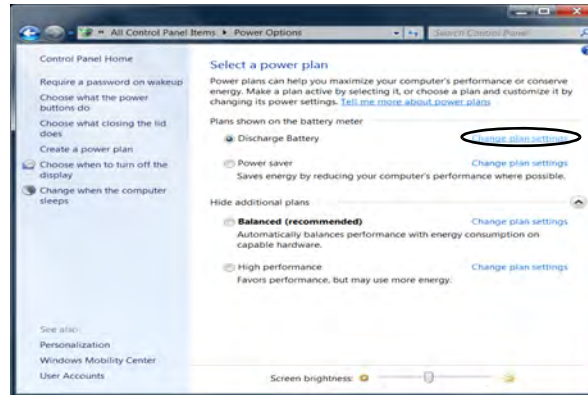

Figure 3 - 8  
Power Plan Create

## Power Management

3. Click **Change plan settings** (after creating it) and click **Change plan settings > Change advanced power settings**.



*Figure 3 - 9*  
**Change Plan  
Settings / Change  
Advanced Power  
Settings**

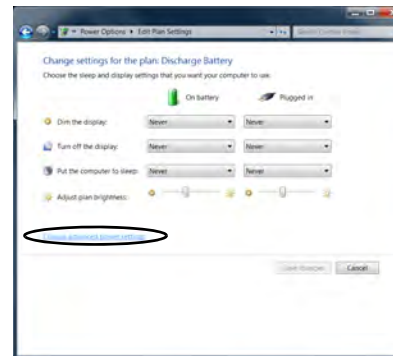

- 4. Scroll down to **Battery** and click **+** to expand the battery options.
- 5. Choose the options below (click **Yes** if a warning appears):

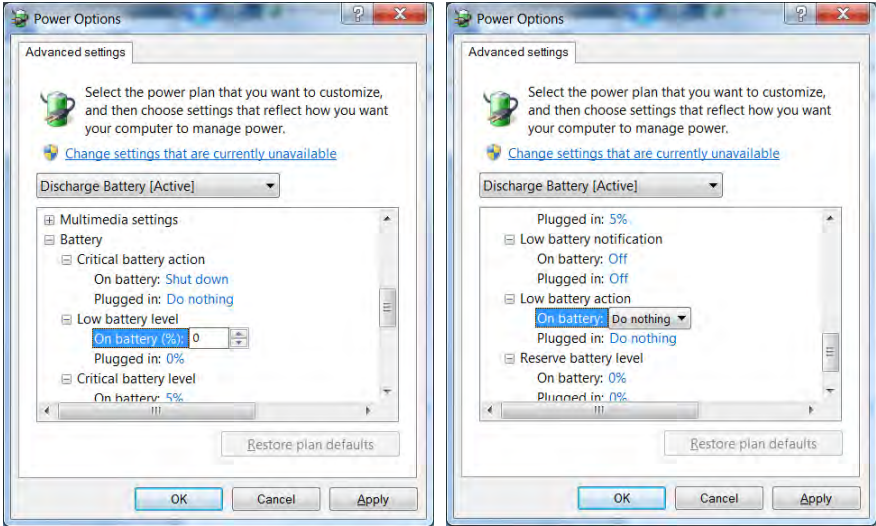

Figure 3 - 10  
Power Options  
Advanced Settings -  
Battery

- Low battery levels = 0%
- Critical battery Levels = 1%
- Low battery action = Do Nothing
- Critical battery action (On battery) = Shut Down
- Critical battery action (Plugged in) = Do Nothing

### **How do I fully charge the battery?**

When charging the battery, don't stop until the LED charging indicator light changes from orange to green.

### **How do I maintain the battery?**

Completely discharge and charge the battery at least once every 30 days or after about 20 partial discharges.



# Chapter 4: Drivers & Utilities

This chapter deals with installing the drivers and utilities essential to the operation or improvement of some of the computer's subsystems. The system takes advantage of some newer hardware components for which the latest versions of most available operating systems haven't built in drivers and utilities. Thus, some of the system components won't be auto-configured with an appropriate driver or utility during operating system installation. Instead, you need to manually install some system-required drivers and utilities.

4

## What to Install

The *Device Drivers & Utilities + User's Manual* disc contains the drivers and utilities necessary for the proper operation of the computer. *Table 4 - 1, on page 4 - 3* lists what you need to install and **it is very important that the drivers are installed in the order indicated.**

### Module Driver Installation

The procedures for installing drivers for the **Wireless LAN, 3.75G/HSPA, PC Camera and Combo Bluetooth & WLAN** modules are provided in *“Modules & Options” on page 7 - 1.*

Make sure any modules (e.g. WLAN, PC Camera, 3.75G/HSPA or Bluetooth) are **ON** before installing the appropriate driver.

# Driver Installation

Insert the *Device Drivers & Utilities + User's Manual* disc into the DVD drive and click **Install Drivers/Option Drivers** (button).

4

Follow the instructions to install the driver. Alternatively click **Start**, navigate (**Browse..**) to the executable file and then follow the manual setup instructions.



Figure 4 - 1 - Drivers Installer Screen 1

1. Check the driver installation order from **Table 4 - 1, on page 4 - 3** (the drivers must be installed in **this order**) which is the same as that listed in the **Drivers Installer** menu below.
2. Click to select the driver you wish to install, (you should note down the drivers as you install them).
3. Follow the instructions for each individual driver installation procedure as listed on the following pages.

Note: If you need to reinstall any driver, you should uninstall the driver first.



Figure 4 - 2 - Drivers Installer Screen 2

Driver for Windows 7	Page #
<i>Video</i>	<i>Page 4 - 5</i>
<i>LAN</i>	<i>Page 4 - 6</i>
<i>TouchPad</i>	<i>Page 4 - 6</i>
<i>CardReader</i>	<i>Page 4 - 6</i>
<i>Hot Key</i>	<i>Page 4 - 6</i>
<i>Audio</i>	<i>Page 4 - 6</i>
<i>AMD AHCI Driver</i>	<i>Page 4 - 7</i>
<i>Wireless LAN Module</i>	<i>Page 7 - 2</i>
<i>PC Camera Module</i>	<i>Page 7 - 8</i>
<i>3.75G/HSPA Module</i>	<i>Page 7 - 19</i>
<i>AMD AHCI Driver</i>	<i>Page 4 - 7</i> <i>Page 7 - 26</i>
<i>Bluetooth Module</i> (Driver required for combo module only)	<i>Page 7 - 28</i>

Table 4 - 1 - Driver Installation

**Manual Driver Installation**

Click *Browse CD/DVD* (button) in the *Drivers Installer* application and browse to the executable file in the appropriate driver folder.

**Windows Update**

After installing all the drivers make sure you enable **Windows Update** in order to get all the latest security updates etc. (all updates will include the latest **hotfixes** from Microsoft). See *“Windows Update” on page 4 - 7* for instructions.

### Updating/Reinstalling Individual Drivers

If you wish to update/reinstall individual drivers it may be necessary to uninstall the original driver. To do this go to the **Control Panel** in the *Windows OS* and double-click the **Programs and Features** icon (**Programs > Uninstall a program**). Click to select the driver (if it is not listed see below) and click **Uninstall**, and then follow the on screen prompts (it may be necessary to restart the computer). Reinstall the driver as outlined in this chapter.

If the driver is not listed in the **Programs and Features** menu:

1. Click **Start**, and click **Control Panel** (or point to **Settings** and click **Control Panel**).
2. Double-click **Device Manager (Hardware and Sound > Device Manager)**.
3. Double-click the **device** you wish to update/reinstall the driver for (you may need to click “+” to expand the selection).
4. Click **Driver** (tab) and click the **Update Driver** or **Uninstall** button and follow the on screen prompts.

### User Account Control

If a **User Account Control** prompt appears as part of the driver installation procedure, click **Continue** or **Allow**, and follow the installation procedure as directed.

### Windows Security Message

If you receive a *Windows* security message as part of the driver installation process. Just click “*Install this driver software anyway*” or “*Install*” to continue the installation procedure.

You will receive this message in cases where the driver has been released after the version of *Windows* you are currently using. All the drivers provided will have already received certification for *Windows*.

## New Hardware Found

If you see the message “**New Hardware Found**” during the installation procedure (**other than when outlined in the driver install procedure**), click **Cancel** to close the window, and follow the installation procedure.



### Driver Installation General Guidelines

The driver installation procedure outlined in this Chapter (and in **Chapter 7 Options & Modules**), are accurate at the time of going to press.

Drivers are always subject to upgrade and revision so the exact procedure for certain drivers may differ slightly. As a general guide follow the default on screen instructions for each driver (e.g. **Next > Next > Finish**) unless you are an advanced user. In many cases a restart is required to install the driver.

Make sure any modules (e.g. PC Camera, WLAN or 3.75G/HSPA) are **ON** before installing the appropriate driver.

## Driver Installation Procedure

Insert the *Device Drivers & Utilities + User's Manual* disc into the DVD drive and click **Install Drivers** (button).

### Video

1. Click **1.Install Video Driver > Yes**.
2. Click **Next > Install** (button).
3. Click the **Express** (or **Custom** if you prefer to manually configure the driver installation settings) button and click **Next**.
4. Click **Accept** (button) and click **Yes**.
5. Click **Finish > Yes** to restart the computer.

**Note:** After installing the video driver go to the **ATI Catalyst Control Center** to adjust the video settings to the highest resolution.

### LAN

1. Click **2.Install LAN Driver > Yes**.
2. Click **Install**.
3. Click **Finish**.

### TouchPad

1. Click **3.Install Touchpad Driver > Yes**.
2. Click **Next**.
3. Click the button to accept the license agreement and click **Next**.
4. Click **Finish > Restart Now** to restart the computer.

### CardReader

1. Click **4.Install Cardreader Driver > Yes**.
2. Click **Install > Finish**.

### Hot Key

1. Click **5.Install Hotkey Utility > Yes**.
2. Click **Next > Next**.
3. Click **Finish > Finish** to restart the computer.

### Audio

1. Click **6.Install Audio Driver > Yes**.
2. Click **Next**.
3. Click the button to agree to the license and click **Next**.
4. Click **Next > Next > Next**.
5. Click **Finish** to restart the computer.

Note that after installing the audio driver the system will not return to the **Drivers Installer** screen. To install any of the optional drivers listed overleaf, eject the *Device Drivers & Utilities + User's Manual* disc and then reinsert it (or double-click the disc icon in My Computer), and click **Option Drivers** (button) to access the optional driver menu.

(See Over)

## AMD AHCI Driver

If you have enabled **AHCI** mode in the BIOS (see *“SATA Mode Selection (Advanced Menu)” on page 5 - 9*), and have not installed the AHCI driver at system installation, then you should do so now as per the instructions below:

1. Insert the *Device Drivers & Utilities + User’s Manual disc* into the CD/DVD drive.
2. Click **Option Drivers** (button).
3. Click **4.Install AMD AHCI Driver > Yes**.
4. Click **Next > Install**.
5. Click **Finish > Finish** to restart the computer.
6. Click **OK** to reboot the system after the driver has been installed and the system restarted.

To uninstall the AMD AHCI driver see the instructions in *“Uninstalling the AMD AHCI Driver” on page 8 - 12*.



### Windows Update

After installing all the drivers make sure you enable **Windows Update** in order to get all the latest security updates etc. (all updates will include the latest **hotfixes** from Microsoft).

To enable **Windows Update** make sure you are connected to the internet:

1. Click **Start**, and click **Control Panel** (or point to **Settings** and click **Control Panel**).
2. Click **Windows Update** (System and Security).
3. Click **Check for updates** (button).
4. The computer will now check for updates (you need to be connected to the internet).
5. Click **Install now** (button) to begin checking for the updates.
6. Click **Install updates** (button) to install the updates.

### Windows Experience Index

After the drivers are installed follow this procedure to ensure an accurate rating from the *Windows Experience Index*:

1. Click **Start**, and click **Control Panel**.
2. Click **Performance Information and Tools** (**System and Security > System > Check the Windows Experience Index**).
3. Click “**Rate this computer**”.
4. The computer will take a few minutes to assess the system performance.
5. Close the control panel.

### Optional Drivers

See the pages indicated for the driver installation procedures for any modules included in your purchase option.

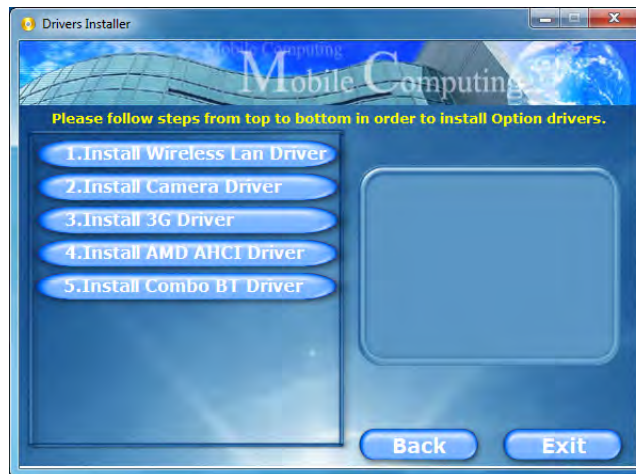

Figure 4 - 3 - Drivers Installer - Option Drivers Menu



## Wireless LAN Module

See the introduction in *“Wireless LAN Module” on page 7 - 2*, and check the installation procedure.

## PC Camera Module

See the introduction in *“PC Camera Module” on page 7 - 7*, and check the installation procedure.

## 3.75G/HSPA Module

See the introduction in *“3.75G/HSPA Module” on page 7 - 15*, and check the installation procedure for the appropriate module.

## Bluetooth Module

**A driver is only required for the Combination Wireless LAN & V3.0 Bluetooth.** See *“Bluetooth Combo Driver Installation” on page 7 - 28*.

The operating system is the default setting for **Bluetooth** control for the **standard V2.0 Bluetooth module** in *Windows 7* and does not require a driver. See *“Standard Bluetooth Configuration in Windows 7” on page 7 - 36* for instructions.



# Chapter 5: BIOS Utilities

## Overview

This chapter gives a brief introduction to the computer's built-in software:

**Diagnostics:** The **POST** (Power-On Self Test)

**Configuration:** The *Setup* utility

If your computer has never been set up, or you are making important changes to the system (e.g. hard disk setup), then you should review this chapter first and note the original settings found in *Setup*. Even if you are a beginner, keep a record of the settings you find and any changes you make. This information could be useful if your system ever needs servicing.

There is one general rule: *Don't make any changes unless you are sure of what you are doing*. Many of the settings are required by the system, and changing them could cause it to become unstable or worse. If you have any doubts, consult your service representative.



### BIOS Settings Warning

Incorrect settings can cause your system to malfunction. To correct mistakes, return to *Setup* and restore the **Setup Defaults** with <F9>.



### POST Screen

1. BIOS information
2. CPU type
3. Memory status
4. Enter **Setup** prompt appears only during **POST**

**Note:** The **POST** screen as pictured right is for guideline purposes only. The **POST** screen on your computer may appear slightly different. If you disable the **Boot-time Diagnostic Screen**, the **POST** screen will not appear.

Figure 5 - 1  
POST Screen

## The Power-On Self Test (POST)

Each time you turn on the computer, the system takes a few seconds to conduct a **POST**, including a quick test of the on-board RAM (memory).

As the **POST** proceeds, the computer will tell you if there is anything wrong. If there is a problem that prevents the system from booting, it will display a system summary and prompt you to run **Setup**.

If there are no problems, the **Setup** prompt will disappear and the system will load the operating system. Once that starts, you can't get into **Setup** without rebooting.

```

Phoenix TrustedCore(tm) NB
Copyright 1985-2006 Phoenix Technologies Ltd.
All Rights Reserved
BIOS Revision ***** 1
KBC/EC Firmware Revision *****
CPU0 = AMD Athlon(tm) X2 Du 2 Core QL-62

632K System RAM Passed 3
3038M Extended RAM Passed
1024 KB L2 Cache
System BIOS shadowed
Video BIOS shadowed
ATAPI CD-ROM: TSSTcorp DVDW TS-L633F
Fixed Disk 0: TOSHIBA MK3265GSX
Mouse initialized

Press <F2> to enter SETUP 4
  
```

## Failing the POST

Errors can be detected during the **POST**. There are two categories, “fatal” and “non-fatal”.

### Fatal Errors

These stop the boot process and usually indicate there is something seriously wrong with your system. Take the computer to your service representative or authorized service center as soon as possible.

### Non-Fatal Errors

This kind of error still allows you to boot. You will get a message identifying the problem (make a note of this message!) followed by the prompt:

- Press <F1> to resume
- <F2> to enter Setup

Press **F1** to see if the boot process can continue. It may work, without the correct configuration.

Press **F2** to run the **Setup** program and try to correct the problem. If you still get an error message after you change the setting, or if the “cure” seems even worse, call for help.

# The Setup Utility

The **Phoenix Setup** utility tells the system how to configure itself and manage basic features and subsystems (e.g. port configuration).

## Entering Setup

To enter *Setup*, turn on the computer and press **F2** during the **POST**. The prompt (*Press F2 to Enter Setup*) seen on page 5 - 2 is usually present for a few seconds after you turn on the system. If you get a “Keyboard Error”, (usually because you pressed **F2** too quickly) just press **F2** again.

If the computer is already on, reboot using the **Ctrl + Alt + Delete** combination and then hold down **F2** when prompted. The *Setup* main menu will appear.

## Setup Screens

The following pages contain additional advice on **portions** of the *Setup*.

Along the top of the screen is a menu bar with menu headings. When you select a heading, a new screen appears. Scroll through the features listed on each screen to make changes to *Setup*.

Instructions on how to navigate each screen are in the box along the bottom of the screen. If these tools are confusing, press **F1** to call up a **General Help** screen, and then use the arrow keys to scroll up or down the page.

The **Item Specific Help** on the right side of each screen explains the highlighted item and has useful messages about its options.

If you see an arrow ► next to an item, press **Enter** to go to a sub-menu on that subject. The sub-menu screen that appears has a similar layout, but the **Enter** key may execute a command.



### Setup Menus

The **Setup** menus shown in this section are for **reference** only. Your computer's menus will indicate the configuration appropriate for your model and options.

# Main Menu

Figure 5 - 2  
Main Menu

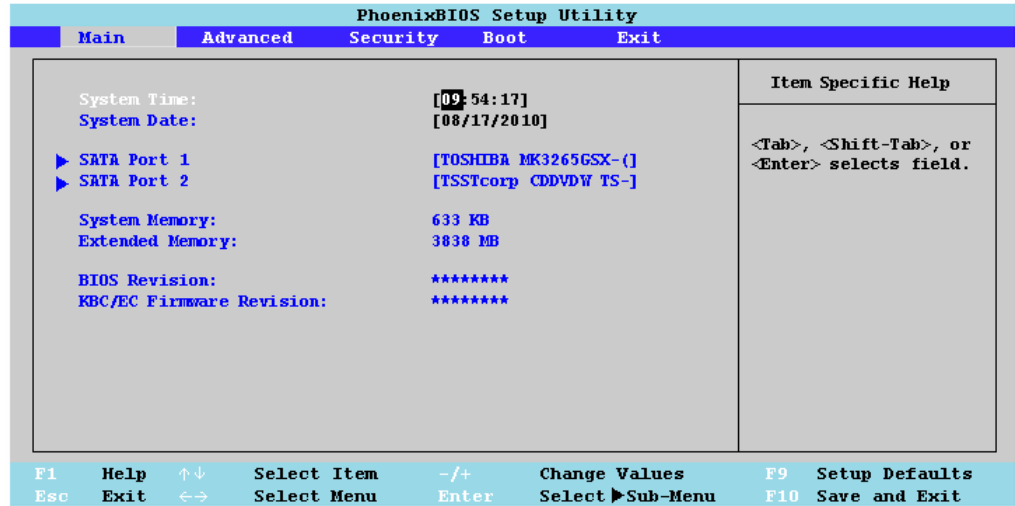

## System Time & Date (Main Menu)

The hour setting uses the 24-hour system (i.e., 00 = midnight; 13 = 1 pm). If you can change the date and time settings in your operating system, you will also change these settings. Some applications may also alter data files to reflect these changes.



### *SATA Port 1/2 (Main Menu)*

Pressing **Enter** opens the sub-menu to show the configuration of a optical Device/HDD on the computer's SATA Port 1/2. Use the **Auto** (Type:) setting to have the items configured automatically for you.

### *System/Extended Memory (Main Menu)*

This item contains information on the system memory, and is not user configurable. The system will auto detect the amount of memory installed.

### *BIOS Revision/KBC/EC Firmware Revision (Main Menu)*

This item contains information on the current BIOS and firmware versions.

## Advanced Menu

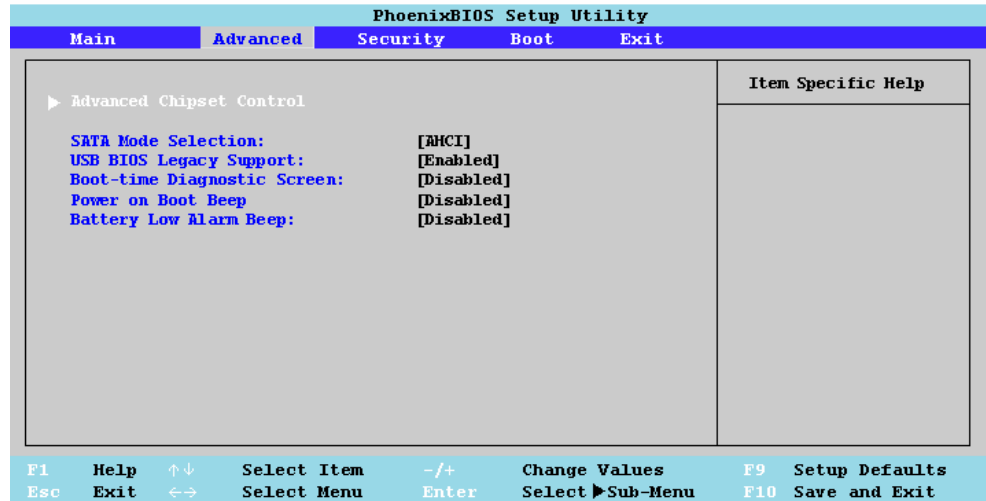

Figure 5 - 3  
Advanced Menu

### *Advanced Chipset Control (Advanced Menu)*

The sub-menu here allows you to enable/disable the **WLAN Power Setting** control. If enabled then the system will remember the last power status of the Wireless LAN module e.g. before a restart or shut down.

### *SATA Mode Selection (Advanced Menu)*

You can configure SATA (Serial ATA) control to operate in either **IDE** (native/compatible) or **AHCI** (Advanced Host Controller Interface) modes from this menu. The **SATA mode** should be set to **AHCI** mode for this system (unless you are sure your hard disk can only operate in **IDE** mode). If you are unsure of the mode your hard disk supports contact your service center. You will need to install the **AMD AHCI driver** after installing all the system drivers (see [“AMD AHCI Driver” on page 4 - 7](#) or [“AMD AHCI Driver” on page 7 - 26](#)).

### *USB BIOS Legacy Support (Advanced Menu)*

Use this menu item to enable/disable the support for Legacy Universal Serial Bus in non-USB aware operating systems.

### *Boot-time Diagnostic Screen (Advanced Menu)*

Use this menu item to enable/disable the Boot-time Diagnostic Screen (see [“The Power-On Self Test \(POST\)” on page 5 - 2](#)).

### *Power on Boot Beep (Advanced Menu)*

Use this menu item to enable/disable the beep as the computer starts up.

### *Battery Low Alarm Beep (Advanced Menu)*

Use this menu item to enable/disable the battery low alarm beep.

# Security Menu



## Security Menu

The changes you make here affect the access to the **Setup** utility itself, and also access to your machine as it boots up after you turn it on. These settings do not affect your machine or network passwords which will be set in your software OS.

5

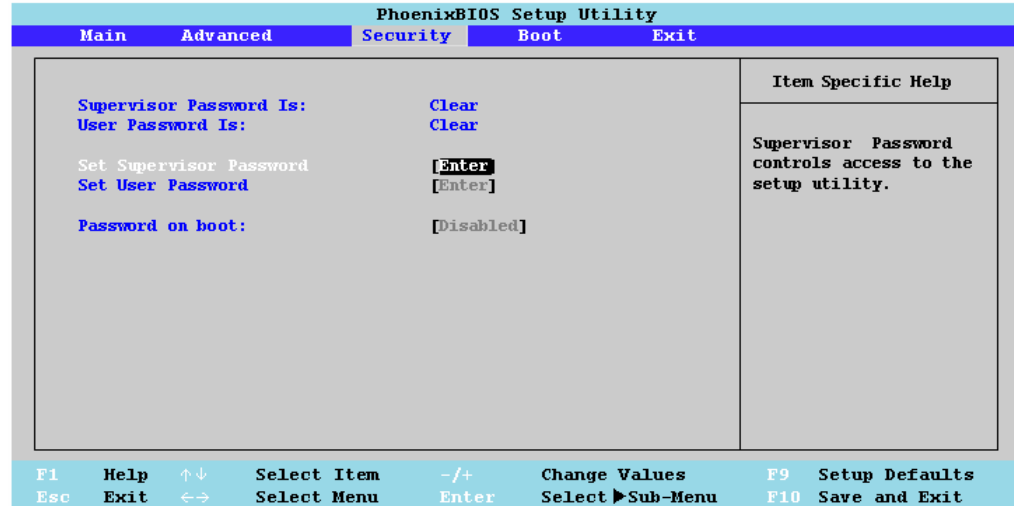

Figure 5 - 4 Security Menu

### Set Supervisor Password (Security Menu)

You can set a password for access to the **PhoenixBIOS Setup Utility**. This will not affect access to the computer OS, (only the **PhoenixBIOS Setup Utility**).

### *Set User Password (Security Menu)*

You can set a password for user mode access to the **PhoenixBIOS Setup Utility**. This will not affect access to the computer OS, (only the *Setup* utility) unless you choose to set a **Password on Boot** (see below). Many menu items in the **PhoenixBIOS Setup Utility** cannot be modified in user mode. You can only set the user password after you have set the supervisor password.

### *Password on boot: (Security Menu)*

Specify whether or not a password should be entered to boot the computer (**you may only set a password on boot if a supervisor password is enabled**). If “*Enabled*” is selected, only users who enter a correct password can boot the system (**see the warning in the sidebar**). The default setting is “*Disabled*”.

**Note:** To clear existing passwords press **Enter** and type the existing password, then press **Enter** for the new password (without typing any password entry) and **Enter** again to confirm the password clearance.



#### Password Warning

If you set a boot password (Password on boot is “Enabled”), **NEVER** forget your password.

The consequences of this could be serious. If you cannot remember your boot password you must contact your vendor and you may lose all of the information on your hard disk.

## Boot Menu

Figure 5 - 5  
Boot Menu

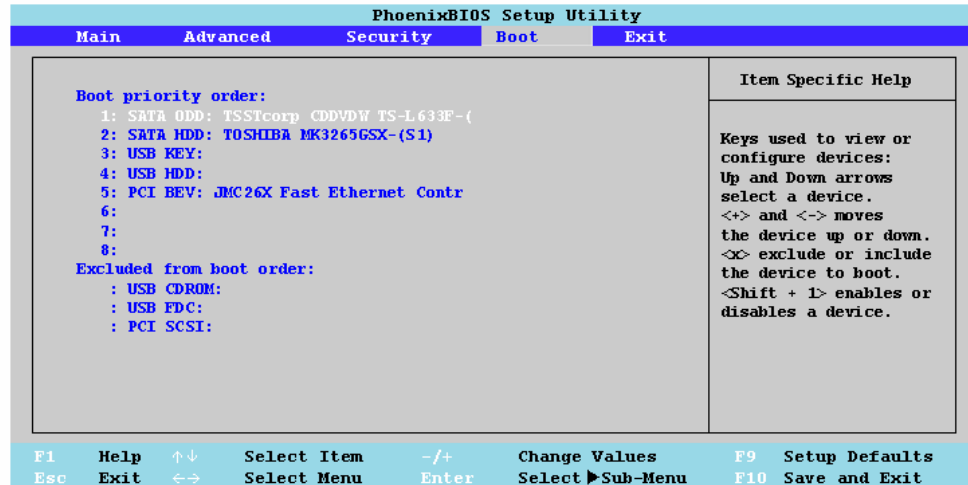

When you turn the computer on it will look for an operating system (e.g. *Windows 7*) from the devices listed in this menu, and **in this priority order**. If it cannot find the operating system on that device, it will try to load it from the next device in the order specified in the **Boot priority order**. Item specific help on the right is available to help you move devices up and down the order.

## Exit Menu

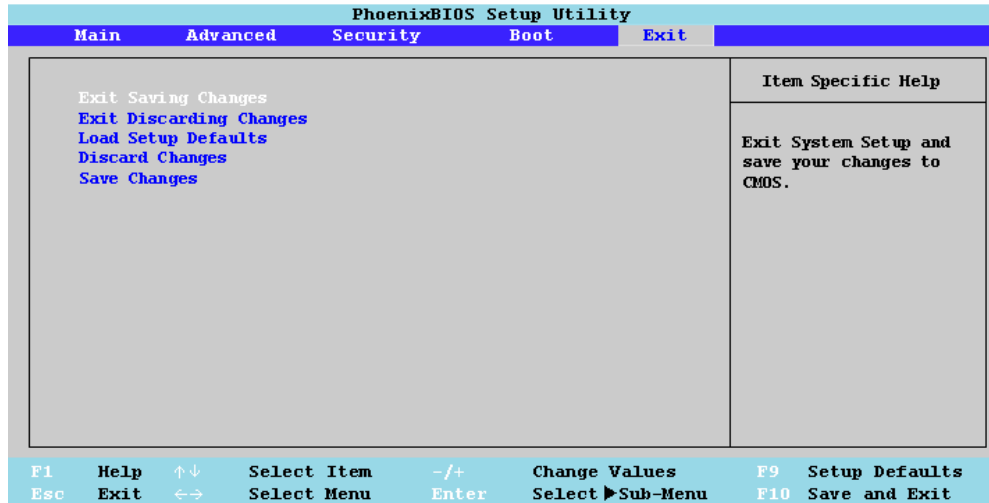

Figure 5 - 6  
Exit Menu

Choosing to *Discard Changes*, or *Exit Discarding Changes*, will wipe out any changes you have made to the *Setup*. You can also choose to restore the original *Setup* defaults that will return the *Setup* to its original state, and erase any previous changes you have made in a previous session.





# Chapter 6: Upgrading The Computer

## Overview

This chapter contains information on upgrading the computer. Follow the steps outlined to make the desired upgrades. If you have any trouble or problems you can contact your service representative for further help. Before you begin you will need:

- A small crosshead or Phillips screwdriver
- A small regular slotted (flathead) screwdriver
- An antistatic wrist strap

Before working with the internal components you will need to wear an antistatic wrist strap to ground yourself because static electricity may damage the components.

The chapter includes:

- Removing the Battery
- Upgrading the Hard Disk Drive
- Upgrading the Optical (CD/DVD) Device
- Upgrading the System Memory (RAM)

**Please make sure that you review each procedure before you perform it.**



### Warranty Warning

Please check with your service representative before undertaking any upgrade procedures to find out if this will VOID your warranty.

### Bottom Covers

Note that the bottom cover pictured in this chapter is for models without the 3.75G option. If your model includes the 3.75G module option then a small cover to enable you to access the module's USIM card will be included.



### Power Safety Warning

Before you undertake any upgrade procedures, make sure that you have turned off the power, and disconnected all peripherals and cables (including telephone lines). It is advisable to also remove your battery in order to prevent accidentally turning the machine on.

### When Not to Upgrade

These procedures involve opening the system's case, adding and sometimes replacing parts.

You should **not** perform any of these upgrades if:

- Your system is still under warranty or a service contract
- You don't have all the necessary equipment
- You're not in the correct environment
- You doubt your abilities

Under any of these conditions, contact your service representative to purchase or replace the component(s).



### Removal Warning

When removing any cover(s) and screw(s) for the purposes of device upgrade, remember to replace the cover(s) and screw(s) before turning the computer on.

### Upgrading the Processor

If you want to upgrade your computer by replacing the existing processor with a faster/new one you will need to contact your customer service representative. We recommend that you do not do this yourself, since if it is done incorrectly you may damage the processor or mainboard.

## Removing the Battery

If you are confident in undertaking upgrade procedures yourself, for safety reasons it is best to remove the battery.

1. Turn the computer **off**, and turn it over.
2. Slide the latch **1** in the direction of the arrow.
3. Slide the latch **2** in the direction of the arrow, and hold it in place.
4. Slide the battery out in the direction of the arrow **3**.



### Warranty Warning

Please check with your service representative before undertaking any upgrade procedures to find out if this will VOID your warranty.

*Figure 6 - 1*  
**Battery Removal**



### HDD System Warning

New HDD's are blank. Before you begin make sure:

- You have backed up any data you want to keep from your old HDD.
- You have all the discs required to install your operating system and programs.
- If you have access to the internet, download the latest application and hardware driver updates for the operating system you plan to install. Copy these to a removable medium.

## Upgrading the Hard Disk Drive

The hard disk drive can be taken out to accommodate other 2.5" serial (SATA) hard disk drives with a height of 9.5mm (h) (see *“Storage” on page C - 2*). Follow your operating system's installation instructions, and install all necessary drivers and utilities (see *“Driver Installation” on page 4 - 2*), when setting up a new hard disk.

1. Turn **off** the computer, and turn it over and remove the battery.
2. Locate the hard disk bay cover and loosen screws **1** & **2**.
3. Remove the hard disk bay cover **3**.

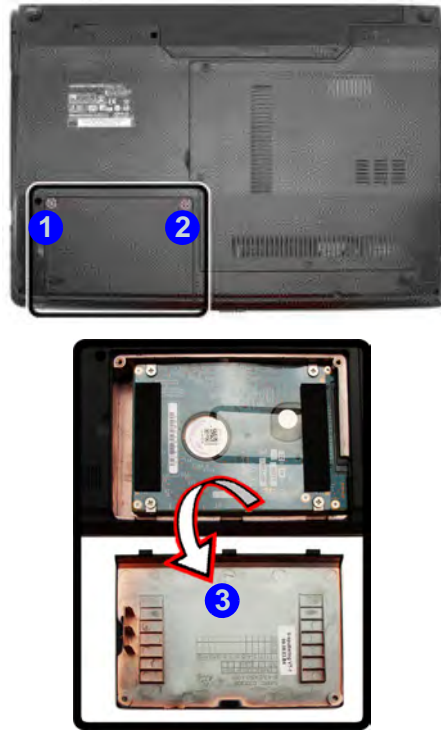

*Figure 6 - 2*  
Hard Disk Bay  
Cover Removal

## Upgrading The Computer



### Hard Disk Screws & Cover

The hard disks and covers pictured here may appear slightly different from your model design (these designs are subject to change and upgrade without notice). Pay careful attention to the screws (if included) and cover orientation.

4. Grip the tab and slide the hard disk in the direction of arrow 4.
5. Lift the hard disk out of the bay 5.
6. Remove the screw(s) 6 - 9 and the adhesive cover 10.
7. Reverse the process to install a new hard disk drive (do not forget to replace all the screws and covers).

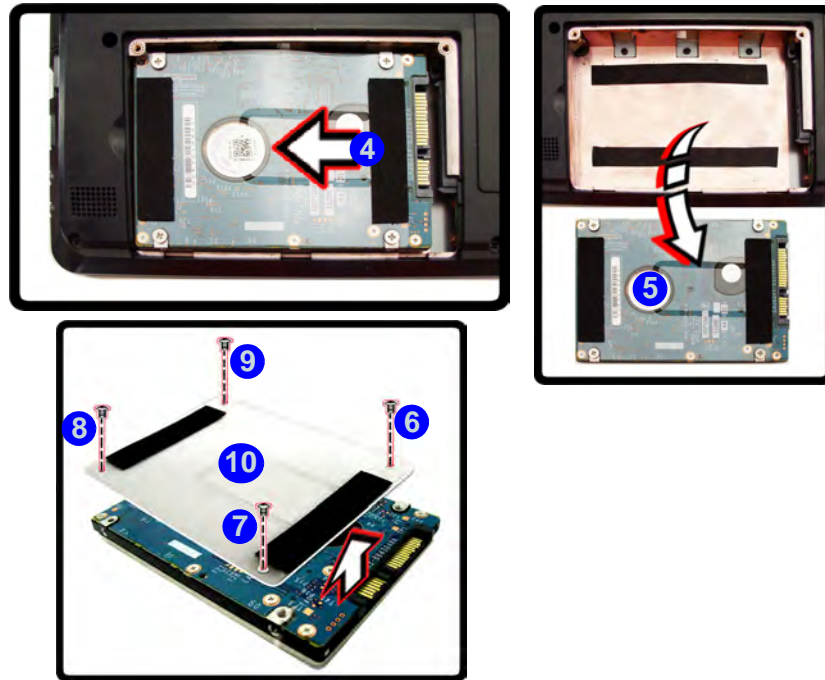

*Figure 6 - 3*  
Hard Disk Removal

## Upgrading the Optical (CD/DVD) Device

1. Turn **off** the computer, and turn it over and remove the battery.
2. Locate the component bay cover and remove screws **1** - **4**.
3. Carefully (**a fan and cable are attached to the under side of the cover**) lift up the bay cover.
4. Carefully disconnect the fan cable **5**, and remove the cover **6**.

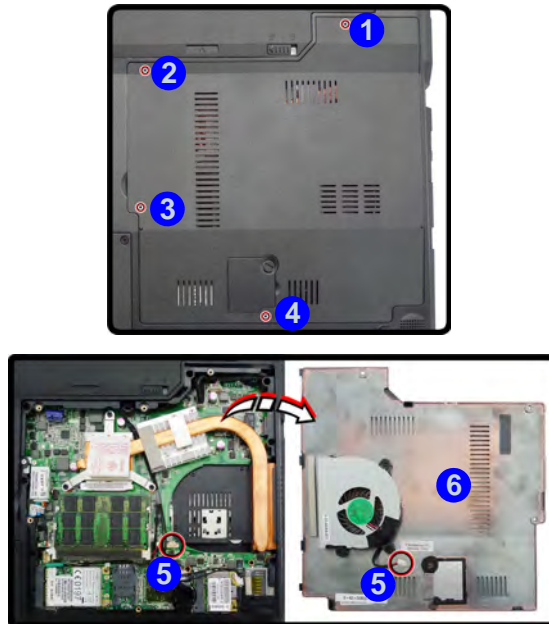

### Fan Cable & Cover

Make sure you reconnect the fan cable **5** before screwing down the bay cover. Note the information on replacing the RAM & CPU bay cover in *“Cover Pins”* on page 6 - 11.

*Figure 6 - 4*  
Removing the  
Component Bay  
Cover

## Upgrading The Computer

5. Remove the screw at point **7**, and use a screwdriver to carefully push out the optical device at point **8**.
6. Reverse the process to install the new device.

*Figure 6 - 5*  
Removing the  
Optical Device





## Upgrading the System Memory (RAM)

The computer has **two** memory sockets for 200 pin Small Outline Dual In-line (SO-DIMM) **DDRII (DDR2)** type memory modules (see *“Memory” on page C - 2* for details of supported module types).

1. Turn **off** the computer, and turn it over and remove the battery.
2. Locate the component bay cover and remove screws **1** - **4**.
3. Carefully (**a fan and cable are attached to the under side of the cover**) lift up the bay cover.
4. Carefully disconnect the fan cable **5**, and remove the cover **6**.

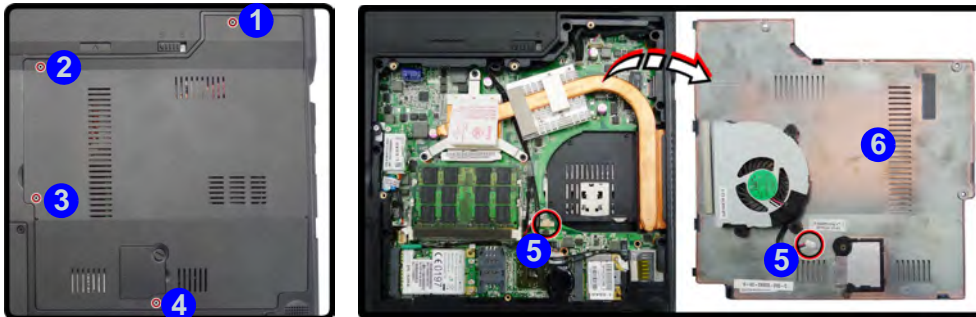

### Fan Cable & Cover

Make sure you reconnect the fan cable **5** before screwing down the bay cover. Note the information on replacing the RAM & CPU bay cover in *“Cover Pins” on page 6 - 11*.

*Figure 6 - 6*  
**Removing the**  
**Component Bay**  
**Cover**

## Upgrading The Computer

5. Gently pull the two release latches on the sides of the memory socket in the direction indicated by the arrows (7 & 8) in *Figure 6 - 7*.

*Figure 6 - 7*  
**RAM Module  
Release Latches**

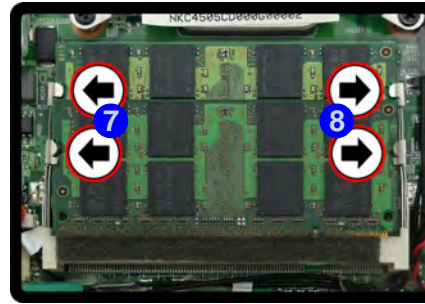

6. The RAM module will 9 pop-up, and you can remove it.

*Figure 6 - 8*  
**RAM Module  
Removal**



- Pull the latches to release the second module if necessary.
- Insert a new module holding it at about a 30° angle and fit the connectors firmly into the memory slot.
- The module's pin alignment will allow it to only fit one way. Make sure the module is seated as far into the slot as it will go. **DO NOT FORCE** the module; it should fit without much pressure.
- Press the module in and down towards the mainboard until the slot levers click into place to secure the module.
- Replace the bay cover (see sidebar) and screws (**make sure you reconnect the fan cable before screwing down the bay cover**).

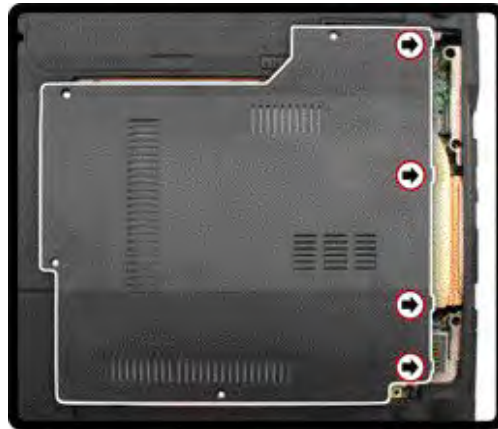

- Restart the computer to allow the BIOS to register the new memory configuration as it starts up.



### Cover Pins

**Note** that this computer model has **four** cover pins. These pins need to be aligned with slots in the case to insure a proper cover fit, before screwing down the bay cover.

*Figure 6 - 9*  
**Component Bay  
Cover Pins**



# Chapter 7: Modules & Options

## Overview

This chapter contains information on the following modules, which may come with your computer, depending on the configuration purchased. If you are unsure please contact your service representative.

- Wireless LAN Module
- PC Camera Module
- 3.75G/HSPA Module
- AMD AHCI Driver
- Bluetooth Module



### Important Notice

If your purchase option includes both **Wireless LAN** and **3.75G/HSPA** modules, then the appropriate antennas will be installed. Note that In order to comply with FCC RF exposure compliance requirements, the antenna must not be co-located or operate in conjunction with any other antenna or transmitter.

#### Important Notice - 3.75G/HSPA & Bluetooth/Wireless LAN Modules

In order to comply with FCC regulations you should NOT operate the 3.75G/HSPA module and the Bluetooth/Wireless LAN modules at the same time as this may disrupt radio frequency, and cause interference. When the 3.75G/HSPA module is powered on, make sure that the Bluetooth/Wireless LAN modules are powered off.



### Wireless Device Operation Aboard Aircraft

The use of any portable electronic transmission devices aboard aircraft is usually prohibited. Make sure the module(s) are **OFF** if you are using the computer aboard aircraft.



### Driver Installation & Module Power

Make sure any modules (e.g. WLAN, PC Camera, 3.75G/HSPA & Bluetooth modules) are **ON** before installing the appropriate driver.



### Wireless Device Operation Aboard Aircraft

The use of any portable electronic transmission devices aboard aircraft is usually prohibited. Make sure the module(s) are OFF if you are using the computer aboard aircraft.

Use the **Fn + F11** key combination to toggle power to the WLAN module, and check the indicator to see if the module is powered on or not (see [Table 1 - 4, on page 1 - 9](#) / [Table 1 - 2, on page 1 - 6](#)).

## Wireless LAN Module

If you have included a **802.11b/g/n WLAN module** in your purchase option, make sure that the Wireless LAN module is on before installing the driver.

Use the **Fn + F11** key combination (see *“Function/Hot Key Indicators” on page 1 - 9*) to **toggle power to the Wireless LAN module**. Make sure you install the drivers in the order indicated in [Table 4 - 1, on page 4 - 3](#).

### 802.11b/g/n Driver Installation

1. Make sure the module is powered on, then insert the *Device Drivers & Utilities + User’s Manual* disc into the CD/DVD drive.
2. Click **Option Drivers** (button).
3. Click **1.Install Wireless Lan Driver > Yes**.
4. Choose the language you prefer and click **Next**.
5. Click **Next > Install**.
6. Click **Finish** to restart the computer.

**Note:** The operating system is the default setting for Wireless LAN control in *Windows* (see overleaf).

## Connecting to a Wireless Network in Windows 7

Make sure the Wireless LAN module is turned on.

1. **Click** the taskbar wireless icon , and then double-click an access point to connect to or click to **Open Network and Sharing Center** if you do not see a network you want to connect to in the taskbar menu (a list of options will appear allowing setting changes, and creating a new network).

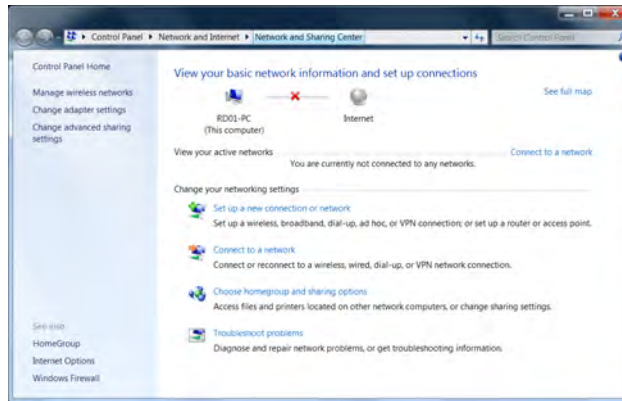

### Network and Sharing Center

You can also use the **Network and Sharing Center** control panel in Windows (**Network and Internet**) to connect to any available wireless networks.

*Figure 7 - 1*  
**Click Taskbar Icon Menu & Network and Sharing Center**



## Modules & Options

2. You may need to enter a security key for any access point to which you are trying to connect.
3. Click to select a network location (e.g. **Home, Work or Public**).
4. Click "**View or change settings in Network and Sharing Center**" to access further options for the connection.

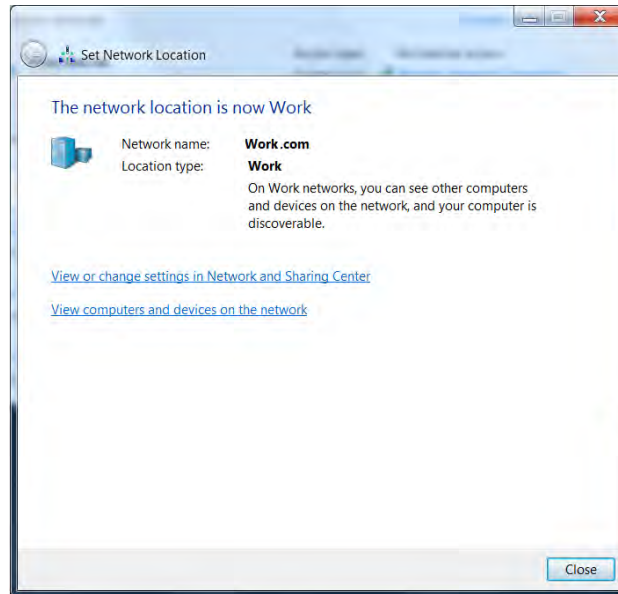
*Figure 7 - 2*  
**Network Location Set**





5. Click the taskbar icon  to see any currently connected networks.
6. To disconnect from the wireless network you can click the taskbar wireless icon , click the active connection and then click **Disconnect** (button).

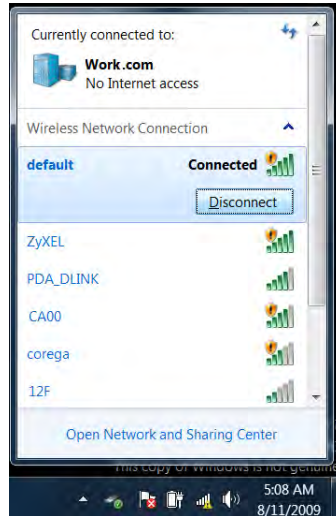

### Security Enabled Networks

You should try to make sure that any network you are connecting to is a secure network.

Connecting to unsecure networks may allow unauthorized access to your computer, documents, websites and files etc.

7

*Figure 7 - 3*  
**Click Taskbar Icon Menu - Disconnect**



### Wireless Hot Keys

The computer's wireless function keys will not function properly if **Wireless** is turned **OFF** in the **Windows Mobility Center** control panel.

The wireless indicators  may show that the WLAN module is powered on, however if wireless is OFF in the Mobility Center, the module will not be powered on.

Make sure that Wireless is **ON** in the Mobility Center to ensure proper function key behavior.

*Figure 7 - 4*  
**Windows Mobility Center**

## Windows Mobility Center

The **Windows Mobility Center** control panel provides an easy point of access for information on battery status, power plans used and wireless device status etc.

To access the Windows Mobility Center:

1. Click **Start**, and click **Control Panel** (or point to **Settings** and click **Control Panel**).
2. Double-click **Windows Mobility Center (Mobile PC)**.
3. Click the button to **Turn wireless off/on**, or click the icon  to access the network menu.

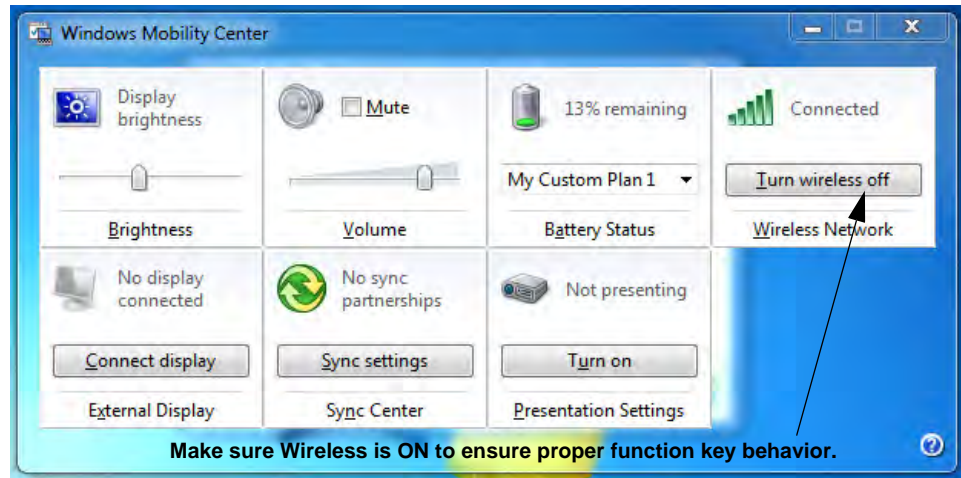

## PC Camera Module

Before installing the **PC Camera** driver, make sure that the optional PC Camera is on. Use the **Fn + F10** key combination (see “*Function/Hot Key Indicators*” on *page 1 - 9*) to toggle power to the **PC Camera module**. Make sure you install the drivers in the order indicated in *Table 4 - 1, on page 4 - 3*.

There are a number of different camera modules available with this computer model series. You will have the appropriate application installed for your camera. **Make sure you access the application via the desktop shortcut.**



### Latest PC Camera Driver Information

Check the *Device Drivers & Utilities + User's Manual disc*, and any accompanying insert pages, for the latest updated information on the PC Camera driver, which may override the information provided here.



### PC Camera Screen Refresh

The PC Camera module supports a frame rate of 12 fps. If you find that the screen refresh rate is subject to lag or stuttering, then **reduce the window size**, or adjust the **Output Size** and/or **Color Space Compression**.

To reduce **Output Size** and/or **Color Space Compression** run the camera application, click **Options** and select **Video Capture Pin**. Adjust the settings from the appropriate pull-down menu.

### PC Camera Driver Installation

1. Use the **Fn + F10** key combination to turn the camera module on.
2. Insert the *Device Drivers & Utilities + User's Manual* disc into the CD/DVD drive.
3. Click **Option Drivers** (button).
4. Click **2.Install Camera Driver > Yes**.
5. Click **Next > Next > Install > Finish** to restart the computer.  
**OR**  
Click **Next > Finish** to restart the computer.  
**OR**  
Click **Next > Install > Finish** to restart the computer.  
**OR**  
Click **Next > Install > Finish > Finish** to restart the computer.
6. Run the camera application program from the desktop shortcut (if the hardware is turned off use the **Fn + F10** key combination to turn it on again).

## PC Camera Audio Setup

If you wish to capture video & **audio** with your camera, it is necessary to setup the audio recording options in *Windows*.

1. Click **Start**, and click **Control Panel** (or point to **Settings** and click **Control Panel**).
2. Click **Sound**  (**Hardware and Sound**).
3. Click **Recording** (tab).
4. Right-click **Microphone** (VIA High Definition Audio) and make sure the item is not disabled.
5. Double-click **Microphone** (or select **Properties** from the right-click menu).
6. Click **Levels** (tab), and adjust the **Microphone** and **Microphone Boost** sliders to the level required.
7. Click **OK** and close the control panels.
8. Run the camera application program from the desktop shortcut.
9. Go to the **Devices** menu heading and select **Microphone (VIA....)** (it should have a tick alongside it).
10. Go to the **Capture** menu heading and select **Capture Audio** (it should have a tick alongside it).

## Modules & Options

Figure 7 - 5  
Audio Setup for PC  
Camera

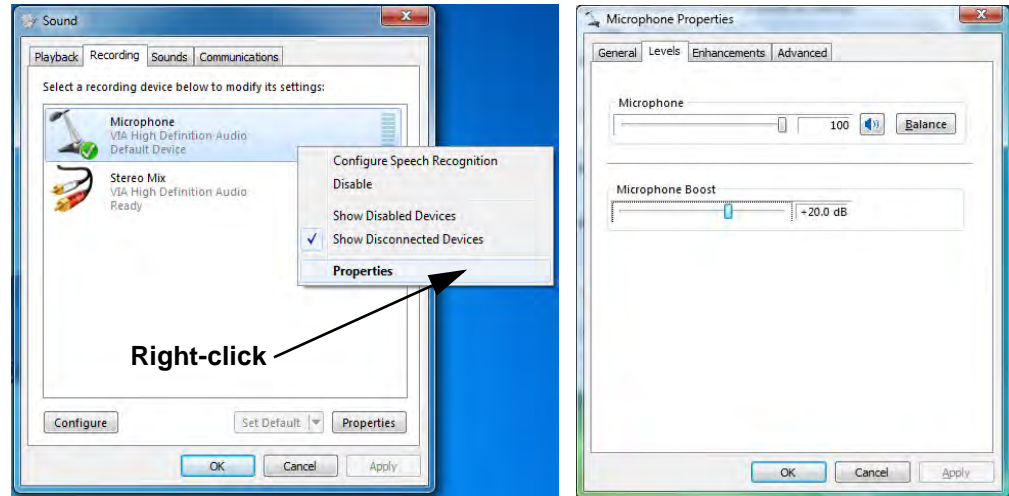

7

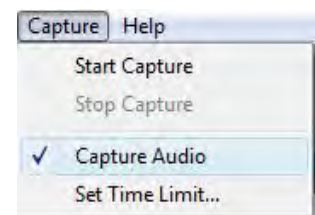
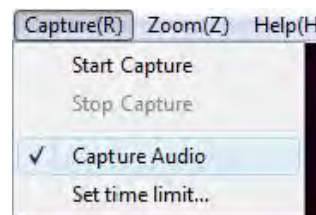
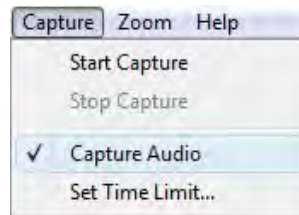

## Camera Application

The camera application is a video viewer for general purpose video viewing and testing, and for capturing video files to .avi format.

1. Run the camera application from the desktop shortcut (it is recommended that you **set the capture file** before the capture process - **see Set Capture File below**).
2. Go to the **Capture** menu heading (if you wish to capture audio check **“PC Camera Audio Setup” on page 7 - 9**) and select **Start Capture**.
3. Click **OK/Yes** (the file location will be displayed in the pop-up box) to start capturing the video, and press **Esc** to stop the capture (you can view the file using the **Windows Media Player**).

## Set Capture File

Prior to capturing video files you may select the **Set Capture File...** option in the **File** menu, and set the file name and location before capture (this will help avoid accidentally overwriting files). Set the name and location then click **Open/Save**, then set the **“Capture file size:”** and click **OK**. You can then start the capture process as above.

Note the important information in **“Reducing Video File Size” on page 7 - 12** in order to save file space, and help prevent system problems.



### Pre-Allocating File Space

You may pre-allocate the file size (**File > Allocate File Space**) for the capture file in the camera application.

Pre-allocating space on the hard disk can improve the capture quality (particularly of large capture files), by reducing the amount of work the hard disk has to do in finding space for the video data as it is being captured.

See also **“Reducing Video File Size” on page 7 - 12**.

### Reducing Video File Size

Note that capturing high resolution video files requires a substantial amount of disk space for each file. After recording video, check the video file size (right-click the file and select **Properties**) and the remaining free space on your hard disk (go to **My Computer**, right-click the hard disk, and select **Properties**). If necessary you can remove the recorded video file to a removable medium e.g. CD, DVD or USB Flash drive.

Note that the *Windows* system requires a minimum of **15GB** of free space on the **C: drive** system partition. In order to prevent system problems it is recommended that you save the captured video file to a location other than the **C: drive** (see *“Set Capture File” on page 7 - 11*), limit the file size of the captured video (see *“Pre-Allocating File Space” on page 7 - 11*) or reduce video resolution (see below).

### To Reduce Video Resolution Output Size:

1. Run the camera application program from the desktop shortcut.
2. Go to **Options** and scroll down to select **Video Capture Pin....**
3. Click the **Output Size** drop box and select a lower resolution size in order to reduce the captured file size.
4. Click **OK**.



## Eliminating Screen Flicker

If you find that the video screen in the camera program is flickering, you can try to adjust the setting in the **Video Capture Filter** options.

1. Run the camera application from the desktop shortcut.
2. Go to **Options** and scroll down to select **Video Capture Filter....**
3. Click either **50Hz** or **60Hz** under **Anti Flicker/Frequency/Powerline Frequency**.

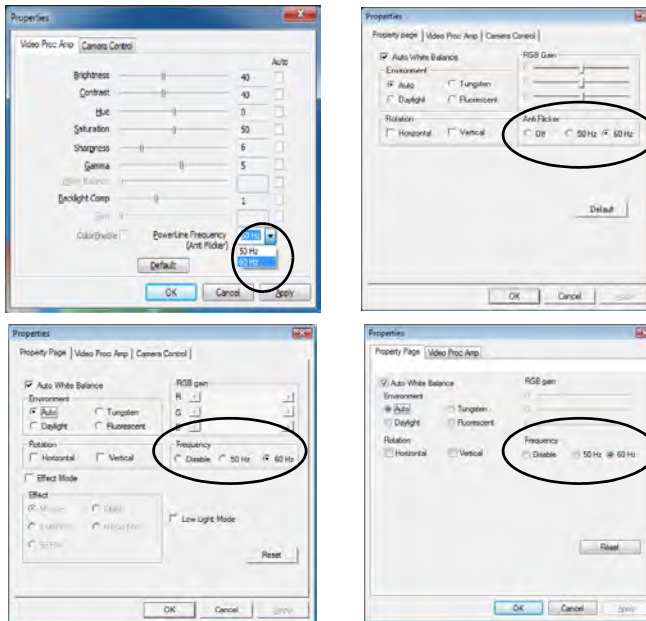

### Latest PC Camera Driver Information

Check the *Device Drivers & Utilities + User's Manual disc*, and any accompanying insert pages, for the latest updated information on the PC Camera driver, which may override the information provided here, including the figures pictured.

Figure 7 - 6  
Video Capture Filter

### Zoom (not applicable to all camera modules)

The camera program allows you to zoom the camera in and out (**note the zoom function is not available in all camera model applications**).

1. Run the camera application from the desktop shortcut.
2. Go to **Zoom** and select **Zoom Out/Zoom In**.

*Figure 7 - 7*  
**Zoom/Setting**



### Taking Still Pictures

The WebCam program allows you to take still pictures.

1. Run the camera application from the desktop shortcut.
2. Go to **Options** and select **Take Picture/Snapshot**.
3. The picture (in JPEG format) will be placed in the **Snapshot** folder  on the desktop.



#### Snapshot Folder

The Snapshot folder's default location is on the desktop. Do not move this folder or an error may appear when you try to take a still picture.

If you accidentally delete or move the folder, you can create a new Snapshot folder on the desktop in order to capture the files.

## 3.75G/HSPA Module

If you have included an **optional 3.75G/HSPA** (High Speed Packet Access) module (see “*Communication*” on page **C - 3** for specification details) in your purchase option, you will have the appropriate application (**Mobile Partner**) provided for your particular module. Follow the instructions on page **7 - 16** to install the USIM card (which will be provided by your service provider), and then install the application.



### Important Notice - 3.75G/HSPA & Bluetooth/Wireless LAN Modules

In order to comply with FCC regulations you should NOT operate the 3.75G/HSPA module and the Bluetooth/Wireless LAN modules at the same time as this may disrupt radio frequency, and cause interference. When the 3.75G/HSPA module is powered on, make sure that the Bluetooth/Wireless LAN modules are powered off.

## Modules & Options

*Figure 7 - 8*  
**USIM Card Cover  
Removal**



### **Power Safety Warning**

Before you undertake any installation procedures, make sure that you have turned off the power, and disconnected all peripherals and cables (including telephone lines). It is advisable to also remove your battery in order to prevent accidentally turning the machine on.

1. Turn **off** the computer, and turn it over and **remove the battery** (see page [6 - 3](#)).
2. Locate the 3.75G USIM card cover and loosen screw **1**, and then remove the USIM card cover **2**.

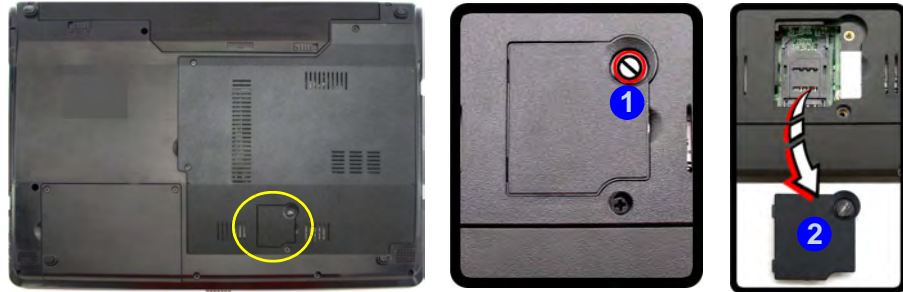

3. Insert the USIM card as you would into your mobile phone.
4. Slide the SIMLOCK towards the hinge in order to release the lock and lift it up.
5. Insert the USIM card as illustrated in ([Figure 7 - 9](#)) and close the SIMLOCK.



*Figure 7 - 9*  
**Insert the USIM Card**

- Lock the SIMLOCK by pushing it in the direction of the arrow in *Figure 7 - 10* until it clicks into the lock position.





*Figure 7 - 10*  
**SIMLOCK Lock**



### **3.75G/HSPA Modules & System Wake Up**

Note that the 3.75G modules **DO NOT** support system wake up on 3.75G/HSPA modem activity.



**Before installing the application, make sure that the 3.75G/HSPA module is ON** (installing the driver with the module off will not allow the software to detect the module hardware correctly). Use the **Fn +  key combination** (see [Table 1 - 4, on page 1 - 9](#)) **to toggle power to the 3.75G/HSPA module**. When the 3.75G/HSPA module is powered on, the indicator  will briefly be displayed. Make sure you install the drivers in the order indicated in [Table 4 - 1, on page 4 - 3](#). **Note that exiting the application does NOT turn off the 3.75G/HSPA module.**

- **Mobile Partner** - See [“Mobile Partner Application Installation” on page 7 - 19](#) for driver installation information and [“Mobile Partner Application” on page 7 - 20](#) for instructions on using the **Mobile Partner** application.

## Mobile Partner

With the **3.75G/HSPA** module and USIM card (supplied by your service provider) installed you may then install the **Mobile Partner** application. The **Mobile Partner** application allows you to directly access your HSPA internet service from the computer.

### Mobile Partner Application Installation

1. Enable power to the module by pressing the **Fn** +  key combination (give the module about 10 seconds to power on - the on screen icon  will indicate the module's power status).
2. If a **Found New Hardware** window appears, click **Cancel** (click **Cancel** for all **Found New Hardware** windows that appear).
3. Insert the **Device Drivers & Utilities + User's Manual disc** into your external optical device drive.
4. Click **Option Drivers** (button).
5. Click **3.Install 3G Driver > Yes**, and then click **Next**.
6. Choose the language you prefer and click **OK > Next**.
7. Click **I Agree** (button) to accept the license agreement.
8. Click **Next > Install**.
9. Click **Finish**.
10. Access the **Mobile Partner** application from the **Start** menu (**Start > Programs/All Programs > Mobile Partner**), or by double-clicking the **Mobile Partner** icon on the desktop.



### Wireless Device Operation Aboard Aircraft

The use of any portable electronic transmission devices aboard aircraft is usually prohibited. Make sure the module(s) are OFF if you are using the computer aboard aircraft.

Use the **Fn** +  key combination to toggle power to the 3.75G/HSPA module, and check the indicator to see if the module is powered on or not (see [Table 1 - 4, on page 1 - 9](#) [Table 1 - 2, on page 1 - 6](#)).



### Mobile Partner Help



To get help on **Mobile Partner** configuration and settings, click the **Help** menu and select **Online Help** or press **F1**.



## Mobile Partner Application

You will need to contact your service provider to obtain the exact details of how exactly to configure the settings on this page.

## Profile Management

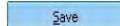

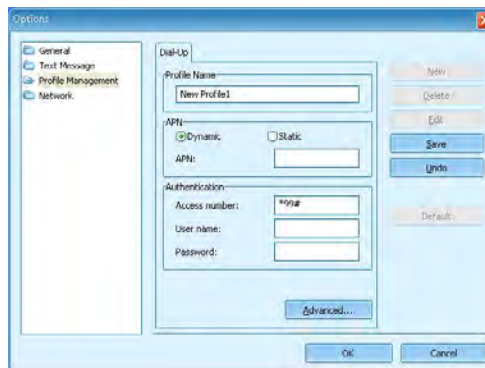
1. Power on the **3.75G/HSPA** module using the **Fn +**  key combination.
2. Access the **Mobile Partner** application from the **Start** menu (**Start > Programs/ All Programs > Mobile Partner**), or by double-clicking the **Mobile Partner** icon on the desktop .
3. If you have not created a profile, click **Tools** and select **Options**, and then click **Profile Management**.
4. Click **New**  and input the appropriate information for **Profile Name**, **APN** and **Authentication** etc. as supplied by your service provider.
5. Click **Save**  to save the profile.



*Figure 7 - 11*  
**Profile Management**



### Connecting to the Service Provider

1. Power on the **3.75G/HSPA** module using the **Fn +**  key combination.
2. Access the **Mobile Partner** application from the **Start** menu (**Start > Programs/ All Programs > Mobile Partner**), or by double-clicking the **Mobile Partner** icon on the desktop .
3. The software will run and you can select the **Profile Name** from the menu.
4. Click **Connect**  to begin the connection process.

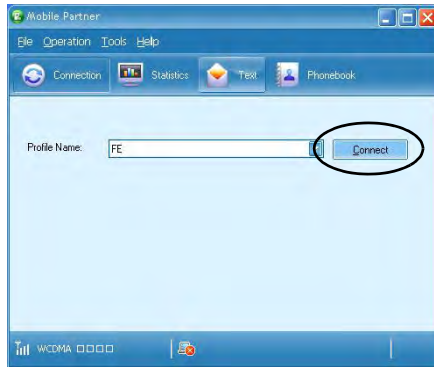

Figure 7 - 12  
Connect

5. The Mobile Partner application will then display the connection information.

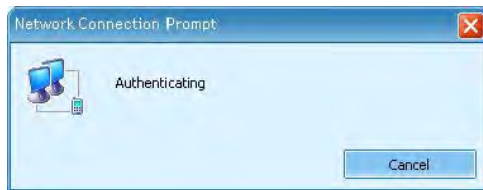



Figure 7 - 13  
Network  
Connection Prompt

## Modules & Options

- When the connection is successful you can move the cursor over the network icon in the taskbar to display the connection information.

*Figure 7 - 14*  
**Connected  
Taskbar  
Notification**



- You can then access the internet, download e-mail etc. as per any internet connection.
- While you are connected the indicators in the Mobile Partner window will display uploading and downloading icons and a network icon in the taskbar .



- To disconnect click the **Disconnect**  icon, or right click the taskbar icon and select **Disconnect**.

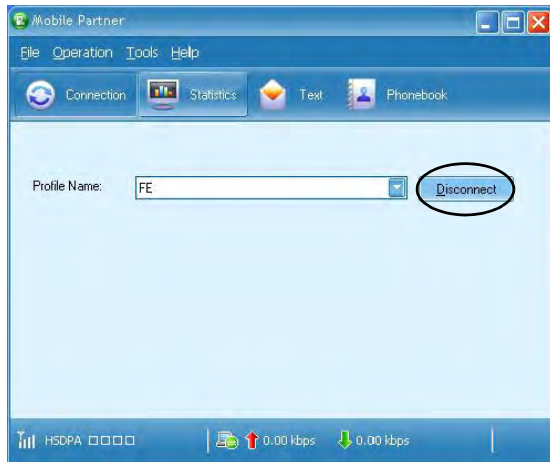



Figure 7 - 15  
Disconnect

- The program will disconnect from the service provider.
- The module will still be on, and you will need to press the **Fn +**  key combination to turn it off.

## Modules & Options



12. If you click the **Mobile Partner** close icon  a message will be displayed asking you to click **OK** to confirm the program exit and to **terminate the connection**.

Figure 7 - 16  
Exit Prompt



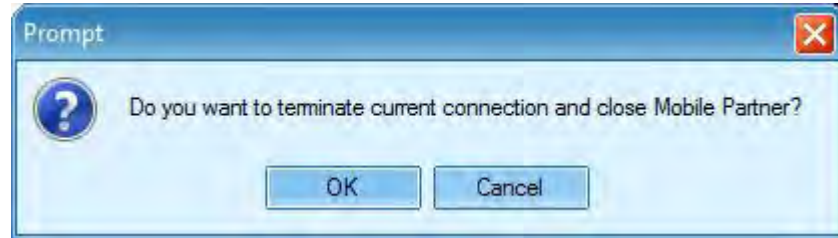

13. Exiting the program terminates the connection, but DOES NOT turn off the 3.75G/HSPA module, and you will need to press the **Fn + ** key combination to turn off the module (pay careful attention to this aboard aircraft - see *[“Wireless Device Operation Aboard Aircraft” on page 7 - 19](#)*).
14. If the module is on and the computer enters a power-saving state, then the power status of the module on resuming from the power-saving state will be as below:
  - If the 3.75G/HSPA module is on and the computer is **Shut Down or Restarted**; the module will be **off** when the computer starts up.
  - If the 3.75G/HSPA module is on and the computer enters **Sleep or Hibernate**; the module will be **off** when the computer resumes from sleep.



## Text Messaging Service

In addition to standard internet services you may also send and receive SMS text messages using the **Mobile Partner** program, if your service supports SMS.

### Reading SMS Messages

1. An icon  will blink at the bottom of the **Mobile Partner** interface to notify you of any new messages received.
2. Click the **Text** icon  in the **Mobile Partner** Interface.
3. Select the **Local > Inbox** or **SIM/USIM Card** folder and select any message to read it.
4. Right-click the message and choose an option to reply, forward or delete the message.

### Creating and Sending SMS Messages

1. Click the **Text** icon  in the **Mobile Partner** Interface.
2. Click the **New** button .
3. Enter the recipient's number in the **Send To...** field or click the **Send To...** button to select an entry from the phone book, and click **OK**.
4. Type in the message details.
5. Click the **Send** button, **Save** button to send the message later or **Close > Yes** to save in the **Draft** folder.

For more details on SMS click the **Help** menu and select **Online Help** or press **F1** and select **SMS**.

### AMD AHCI Driver

If you have enabled **AHCI** mode in the BIOS (see *“SATA Mode Selection (Advanced Menu)” on page 5 - 9*), and have not installed the AHCI driver at system installation, then you should do so now as per the instructions below:

1. Insert the *Device Drivers & Utilities + User’s Manual disc* into the CD/DVD drive.
2. Click **Option Drivers** (button).
3. Click **4.Install AMD AHCI Driver > Yes**.
4. Click **Next > Install**.
5. Click **Finish > Finish** to restart the computer.
6. Click **OK** to reboot the system after the driver has been installed and the system restarted.
7. To uninstall the AMD AHCI driver see the instructions in *“Uninstalling the AMD AHCI Driver” on page 8 - 12*.

## Bluetooth Module

There are two Bluetooth module options available for this computer. If your purchase option includes the **Combination Wireless LAN & V3.0 Bluetooth module** then install the driver as instructed overleaf (see *“Bluetooth & WLAN Combo Settings” on page 7 - 29* for configuration instructions).

If your purchase option includes a **standard V2.1 Bluetooth module**, then the operating system’s **Bluetooth Devices** control panel is used to configure the Bluetooth settings in *Windows 7*, and therefore does not require a driver (see *“Standard Bluetooth Configuration in Windows 7” on page 7 - 36*).

Use the **Fn + F12** key combination to toggle power to the Bluetooth module (see *“Function Keys & Visual Indicators” on page 1 - 9*). When the Bluetooth module is powered on the indicator  will briefly be displayed.



### Bluetooth Data Transfer

Note that the transfer of data between the computer and a Bluetooth enabled device is supported in **one direction only (simultaneous data transfer is not supported)**. Therefore if you are copying a file from your computer to a Bluetooth enabled device, you will not be able to copy a file from the Bluetooth enabled device to your computer until the file transfer process from the computer has been completed.



### Wireless Device Operation Aboard Aircraft

The use of any portable electronic transmission devices aboard aircraft is usually prohibited. Make sure the module(s) are OFF if you are using the computer aboard aircraft.

Use the **Fn + F12** key combination to toggle power to the Bluetooth module, and check the LED indicator to see if the module is powered on or not (see *Table 1 - 2, on page 1 - 9/ Table 1 - 1, on page 1 - 7*).



### High Speed Bluetooth Data Transfer

The **Combination Wireless LAN & V3.0 Bluetooth module** supports high speed (V3.0) data transfer. However to achieve such transfer speeds, **both devices must support high speed data transfer.**

Check your Bluetooth compatible device's documentation to confirm it supports high speed data transfer.

## Bluetooth Combo Driver Installation

*Note this driver is required only for the combo Bluetooth and WLAN module only.*

1. Make sure the module is powered on, then insert the *Device Drivers & Utilities + User's Manual* disc into the CD/DVD drive.
2. Click **Option Drivers** (button).
3. Click **5.Install Combo BT Driver > Yes.**
4. Choose the language you prefer and click **OK.**
5. Click **Next.**
6. Click the button to accept the license and click **Next.**
7. Click **Next >** (*select if you want to create an icon to appear on the desktop*)  
**Next > Install.**
8. Click **Finish.**
9. The **My Bluetooth** icon  will appear on the desktop and the **Bluetooth** item will be installed in the **Programs/All Programs** menu.
10. See "*Bluetooth Networking Setup*" on page 7 - 32 for information on Bluetooth networking.



## Bluetooth & WLAN Combo Settings

*This information applies to the combo Bluetooth and WLAN module only.*

1. Make sure the Bluetooth module is powered on.
2. Double-click the **My Bluetooth** application on the desktop (or access it from the **Programs/All Programs** menu).
3. Click **My Bluetooth Settings** (menu heading).

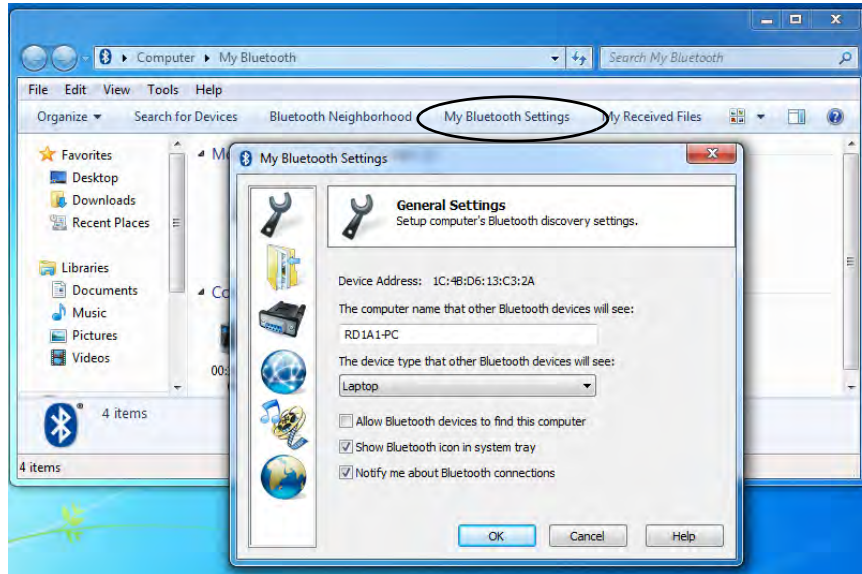

### Bluetooth Module & Resuming From Sleep Mode

The Bluetooth module's default state will be off after resuming from the **Sleep** power-saving state. Use the key combination (**Fn + F12**) to power on the Bluetooth module after the computer resumes from Sleep.

Figure 7 - 17  
My Bluetooth Settings

## Modules & Options

4. Click **General Settings**  to change the computer **name that other Bluetooth devices will see**, and click the tickbox to **Allow Bluetooth devices to find this computer**
5. Click **OK** to confirm the settings.

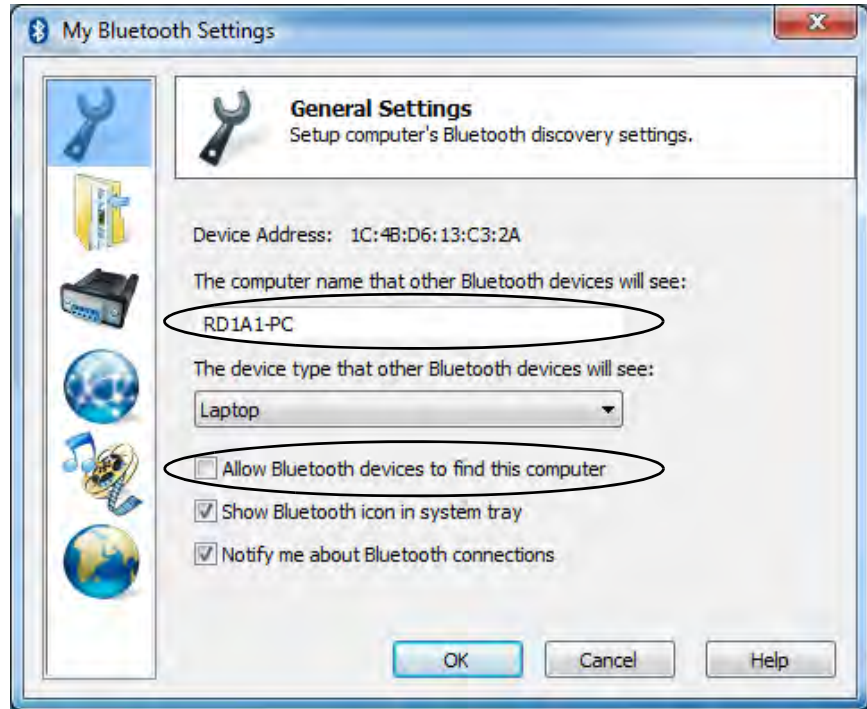

7  
*Figure 7 - 18*  
**General Settings**

6. Click **File Transfer Settings**  to **Enable sharing of my files with other Bluetooth devices**.
7. Click **OK** to confirm the settings.

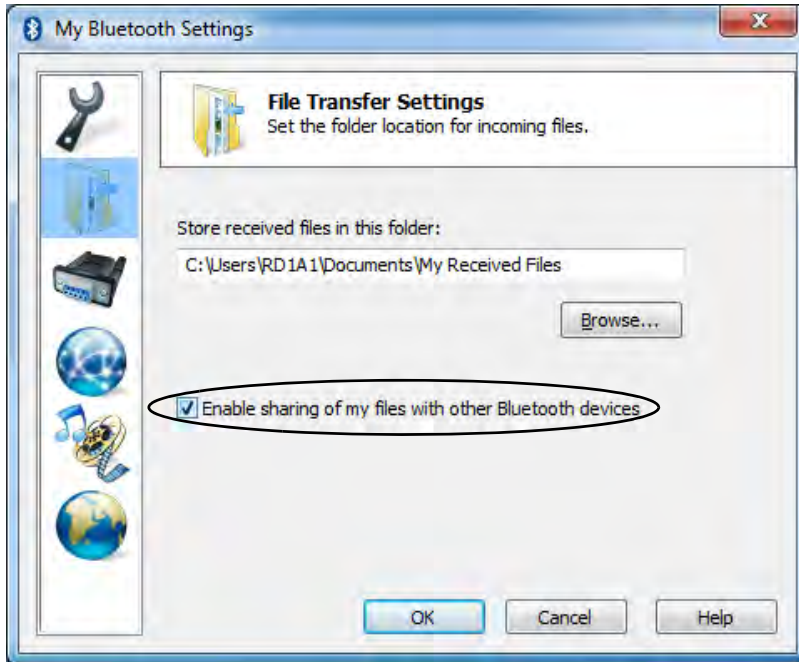
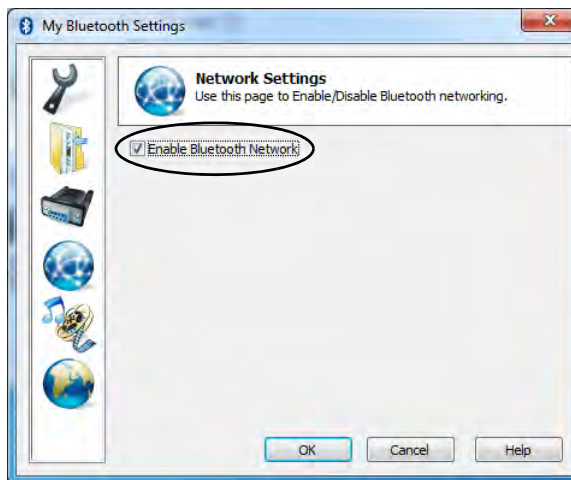

*Figure 7 - 19*  
**File Transfer Settings**

### Bluetooth Networking Setup

*This information applies to the combo Bluetooth and WLAN module only.*

1. Make sure the Bluetooth module is powered on.
2. Double-click the **My Bluetooth** application on the desktop (or access it from the **Programs/All Programs** menu).
3. Click **My Bluetooth Settings** (see [Figure 7 - 17 on page 7 - 29](#)).



*Figure 7 - 20*  
**Network Settings**

4. Click **Network Settings** (make sure the Bluetooth module is powered on).
5. Click **Enable Bluetooth Network** and click **OK**.
6. A message will appear in the taskbar to confirm that the network driver has been installed.

## Bluetooth & WLAN Combo Module Configuration

*This information applies to the combo Bluetooth and WLAN module only.*

### Setup your Bluetooth Device so the Computer Can Find it

1. Turn your Bluetooth device (e.g. PDA, mobile phone etc.) on.
2. Make the device discoverable (to do this check your device documentation).

### To Turn the Bluetooth Module On

1. Press the **Fn + F12** key combination to power on the Bluetooth module.

### To Add a Bluetooth Device

1. Double-click the **My Bluetooth** application on the desktop (or access it from the **Programs/All Programs** menu).
2. Double-click the device you want to pair with the computer (if no devices appear press **F5** or click the **Refresh** button to search for devices).

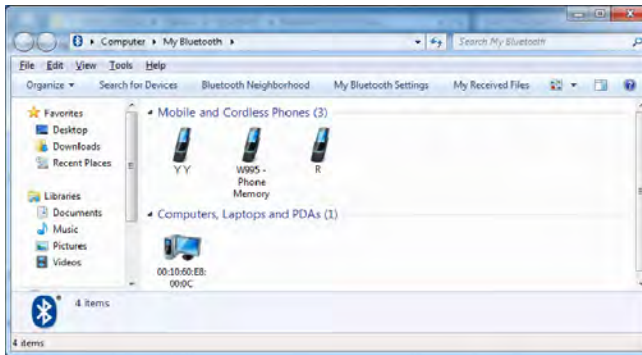



Figure 7 - 21  
My Bluetooth  
Devices



**Bluetooth Module & Resuming From Sleep Mode**

The Bluetooth module's default state will be off after resuming from the **Sleep** power-saving state. Use the key combination (**Fn + F12**) to power on the Bluetooth module after the computer resumes from Sleep.

3. You will then be presented with a menu of options to select from.



7  
*Figure 7 - 22*  
**Bluetooth Device  
Options**

4. Click the appropriate button to connect to the device.

5. You may need to allow the connection from your device, and you will then need to provide a passcode from the device.
6. You can then enter the passcode on the computer and click **OK** to establish the connection.

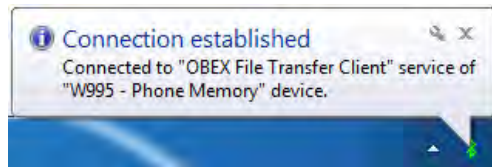
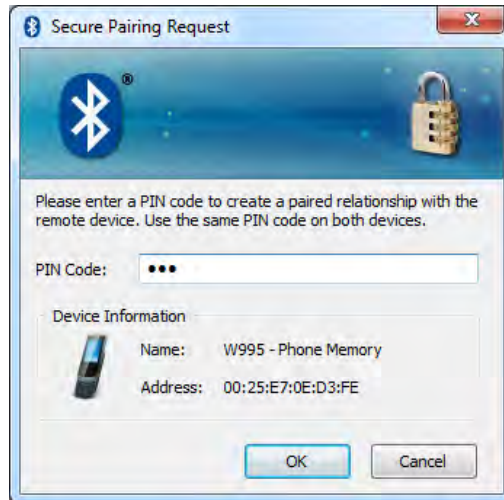

*Figure 7 - 23*  
**Bluetooth Pairing  
Code & Connection  
Established**





### Add a Device

Click **Start**, and click **Control Panel** and then click **Devices and Printers (Hardware and Sound)**. Click **Add a device** to search for any available Bluetooth devices.

### Bluetooth Module & Resuming From Sleep Mode



The Bluetooth module's default state will be off after resuming from the **Sleep** power-saving state. Use the key combination (**Fn + F12**) to power on the Bluetooth module after the computer resumes from Sleep.

## Standard Bluetooth Configuration in Windows 7

### Setup your Bluetooth Device so the Computer Can Find it

1. Turn your Bluetooth device (e.g. PDA, mobile phone etc.) on.
2. Make the device discoverable (to do this check your device documentation).

### To Turn the Bluetooth Module On

1. Press the **Fn + F12** key combination to power on the Bluetooth module.
2. A Bluetooth icon  will appear in the taskbar.
3. You can then do any of the following to access the **Bluetooth Devices** control panel.
  - **Double-click** the taskbar icon  to access the **Bluetooth Devices** control panel.
  - **Click/Right-click** the taskbar icon  and choose an option from the menu.

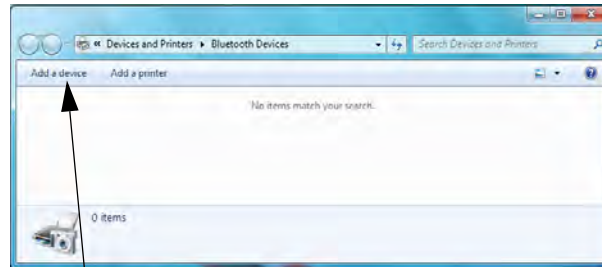

Add a device

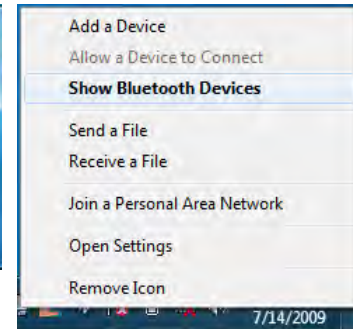

Right-Click Taskbar Icon 

Figure 7 - 24

### Bluetooth Devices & Click Icon Menu



### To Add a Bluetooth Device

1. Access the **Bluetooth Devices** control panel and click **Add a device**.
2. Double-click the device you want to pair with the computer.

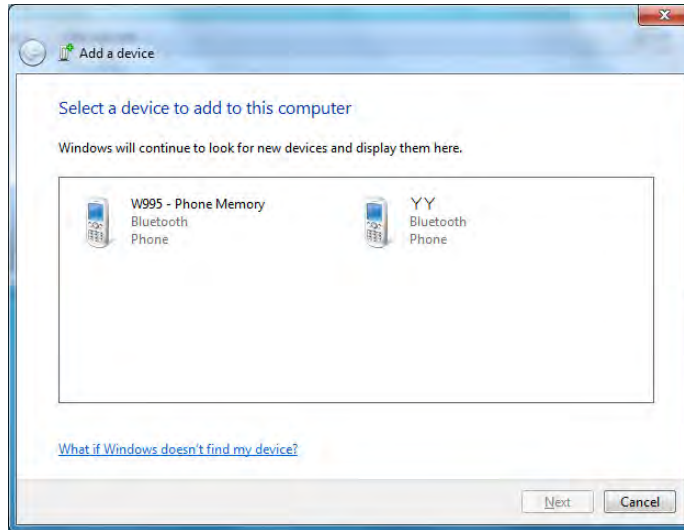

3. On first connection the computer will provide you with a pairing code to be entered onto the device.



#### Pairing Options

If a device has been previously connected then the pairing option menu will appear when you attempt subsequent connections. You can choose to have the computer create a pairing code for you, use the device's existing pairing code or you can pair certain devices without using a code.

7

Figure 7 - 25  
Add a Device

4. Enter the code into your Bluetooth enabled device and follow any on-screen instructions to complete the pairing.

*Figure 7 - 26*  
**Pairing Code Example**

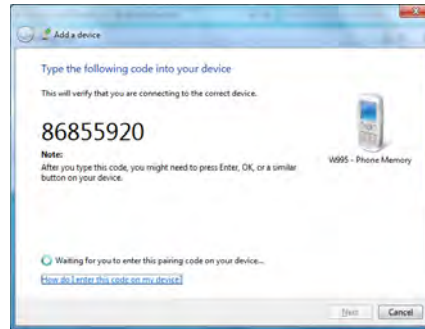

### Pairing Codes

The example outlined here shows a connection to a mobile device. Other devices e.g. computers, may have a slightly different connection procedure, and may require you to confirm a pairing code is correct on both devices. Follow the on-screen instructions to complete the pairing.

5. **Windows** will check to see if any drivers are required to complete the pairing.
6. Follow any on-screen instructions on the computer if device drivers are required to be installed.
7. Click **Close**.

*Figure 7 - 27*  
**Pairing Complete & Bluetooth Device Enabled**

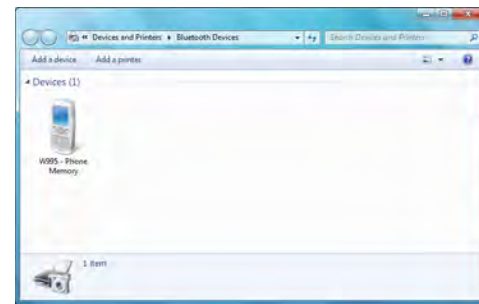
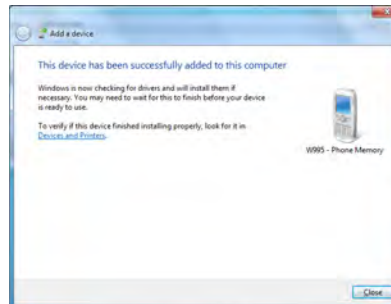

## To Change Settings for the Bluetooth Device

1. Click the taskbar icon and select **Show Bluetooth Devices**.
2. Right-click on the device you want to change and click **Properties** to:
  - Change the **name** of the device (click **Bluetooth**, type a new name and click **OK**).
  - Enable/Disable a **service** (click **Services**, clear/tick the check box next to the service and click **OK**).

## To Make your Computer Discoverable to Bluetooth Devices

1. Click the taskbar icon and select **Open Settings**.
2. Click **Options**, and make sure that **Allow Bluetooth devices to find this computer** check box (**Discovery**) has a tick inside it.
3. Make sure that the **Alert me when a new Bluetooth device wants to connect** check box (**Connections**) has a tick inside it, if you want to be notified when a Bluetooth device wants to connect.

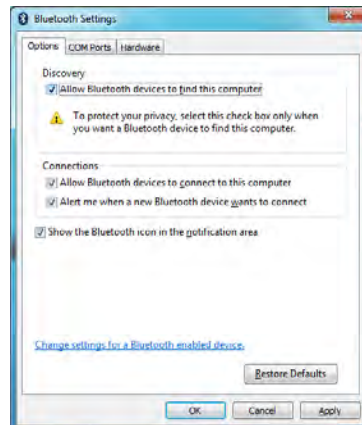

### Bluetooth Help

To get help on Bluetooth configuration and settings, select **Help and Support** from the **Start** menu. Type Bluetooth in the **Search Help** box, and select an item from the returned search results to get more information.

Figure 7 - 28  
Bluetooth Settings -  
Options



# Chapter 8: Troubleshooting

## Overview

Should you have any problems with your computer, before consulting your service representative, you may want to try to solve the problem yourself. This chapter lists some common problems and their possible solutions. This can't anticipate every problem, but you should check here before you panic. If you don't find the answer in these pages, make sure you have followed the instructions carefully and observed the safety precautions in the preface. If all else fails, talk to your service representative. You should also make a record of what happened and what remedies you tried.

Of course, if something goes wrong, it will happen at the most inconvenient time possible, so you should preview this section just in case. If, after you've tried everything, and the system still won't cooperate, try turning it off for a few minutes and then rebooting. You will lose any unsaved data, but it may start working again. Then call your service representative.

# Basic Hints and Tips

Many of the following may seem obvious but they are often the solution to a problem when your computer appears not to be working.

- **Power** - Is the computer actually plugged into a working electrical outlet? If plugged into a **power strip**, make sure it is actually working. Check the **LED Power & Communication Indicators** (see *“LED Indicators” on page 1 - 6*) to see the computer’s power status.
- **Connections** - Check all the **cables** to make sure that there are no **loose connections** anywhere.
- **Power Savings** - Make sure that the system is not in **Hibernate** or **Sleep** mode by pressing the keys configured in your *Power Options* (see *“Power-Saving States” on page 3 - 6*), the **Fn + F4** key combination, or power button to wake-up the system.
- **Brightness** - Check the brightness of the screen by pressing the **Fn + F8 and F9** keys to adjust the brightness.
- **Display Choice** - Press **Fn + F7** to make sure the system is not set to “external only” display.
- **Boot Drive** - Make sure there are no **optical media and/or USB storage devices** in any connected drive (this is a common cause of the message *“Invalid system disk - Replace the disk, and then press any key”* / *“Remove disks or other media. Press any key to restart”*).

## Backup and General Maintenance

- Always **backup** your important data, and keep copies of your OS and programs safe, but close to hand. Don't forget to note the **serial numbers** if you are storing them out of their original cases, e.g. in a CD wallet.
- Run **maintenance programs** on your hard disk and OS as often as you can. You may schedule these programs to run at times when you are not using your computer. You can use those that are provided free with your OS, or buy the more powerful dedicated programs to do so.
- Write down your passwords and keep them safe (away from your computer). This is especially important if you choose to use a **Supervisor** password for the BIOS (see *“The Power-On Self Test (POST)” on page 5 - 2*).
- Keep copies of vital **settings files** such as network, dialup settings, mail settings etc.(even if just brief notes).



### Warranty

The CPU is not a user serviceable part. Opening this compartment, or accessing the CPU in any way, may violate your warranty.

# Viruses

- Install an **Anti-Virus** program and keep the **definitions file** (the file which tells your program which viruses to look for) up to date. New computer viruses are discovered daily, and some of them may seriously harm your computer and cause you to lose data. **Anti-Virus** programs are commercially available and the **definitions file updates** are usually downloadable directly from the internet.
- Be careful when opening e-mail from sources you don't know. **Viruses** are often triggered from within **e-mail attachments** so take care when opening any attached file. You can configure most **Anti-Virus** programs to check all **e-mail attachments**. **Note:** You should also beware of files from people you know as the virus may have infected an **address book** and been automatically forwarded without the person's knowledge.
- Keep a "**Bootable CD-ROM/DVD-ROM/USB storage device**" (this CD/DVD/USB device provides basic information which allows you to startup your computer) handy. You may refer to your OS's documentation for instructions on how to make one, and many **Anti-Virus** programs will also provide such a disk (or at least instructions on how to make one).



## Upgrading and Adding New Hardware/Software

- Do not be tempted to make changes to your **Windows Registry** unless you are very sure of what you are doing, otherwise you will risk severely damaging your system.
- Don't open your computer or undertake any repair or upgrade work if you are not comfortable with what you are doing.
- Read the **documentation**. We can assume, since you are reading this that you are looking at the computer's manual, but what about any new peripheral devices you have just purchased? Many problems are caused by the installation of new hardware and/or software. Always refer to the documentation of any new hardware and/or software, and pay particular attention to files entitled "**READ ME**" or "**READ ME FIRST**".
- When installing a new device always make sure the device is powered on, and in many cases you will need to restart the computer. Always check that all the cables are correctly connected.
- Make sure you have installed the **drivers** for any new hardware you have installed (latest **driver files** are usually available to download from vendor's websites).

## Troubleshooting



- Thoroughly check any **recent changes** you made to your system as these changes may affect one or more system components, or software programs. If possible, go back and undo the change you just made and see if the problem still occurs.
- Don't over complicate things. The less you have to deal with then the easier the source of the problem may be found; **Example** - if your computer has many devices plugged into its ports, and a number of programs running, then it will be difficult to determine the cause of a problem. Try disconnecting all of the devices and restarting the computer with all the peripheral devices unplugged. A process of elimination (adding and removing devices and restarting where necessary) will often find the source of a problem, although this may be time consuming.

## Problems and Possible Solutions



Problem	Possible Cause - Solution
<p>You turned on the <b>power</b> but it doesn't work.</p>	<p><i>Battery missing / incorrectly installed.</i> Check the battery bay, make sure the battery is present and seated properly (the design of the battery only allows it to go in one way). Make sure there's nothing interfering with the battery contacts.</p>
<p>The battery <b>LED power</b> indicator , is blinking orange.</p>	<p><i>Low Battery.</i> Plug in the DC power source. If the computer doesn't start up immediately, turn it off then on again.</p>
<p>You are <b>losing battery power</b> too quickly.</p>	<p><i>The system is using too much power.</i> If your OS has a <i>Power Options</i> scheme (see "<a href="#">Power Plans</a>" on page 3 - 4) check its settings. You may also be using a USB device/external device that is drawing a lot of power.</p>
<p>Actual <b>battery operating time</b> is shorter than expected.</p>	<p><i>The battery has not been fully discharged before being recharged.</i> Make sure the battery is fully discharged and recharge it completely before reusing (see "<a href="#">Energy Star Power Saving</a>" on page 3 - 10).</p> <p><i>Power Options have been disabled.</i> Go to the <b>Control Panel</b> in <i>Windows</i> and re-enable the options.</p> <p><i>A peripheral device/USB device is consuming a lot of power.</i> Turn off/remove the unused device to save power.</p>

## Troubleshooting

Problem	Possible Cause - Solution
<p>The computer feels <b>too hot</b>.</p>	<p>Make sure the computer is properly ventilated and the Vent/Fan intakes are not blocked. If this doesn't cool it down, put the system into <b>Hibernate</b> mode or turn it off for an hour. Make sure the computer isn't sitting on a thermal surface (see <a href="#">“Overheating” on page 1 - 12</a>). Make sure you're using the correct adapter.</p> <p>Make sure that your notebook is completely powered off before putting it into a travel bag (or any such container). Putting a notebook which is powered on in a travel bag may cause the Vent/Fan intakes to be blocked.</p>
<p><b>Nothing appears</b> on screen.</p>	<p><i>The system is in a power saving mode.</i> Toggle the sleep/resume key combination, <b>Fn + F4</b> (see <a href="#">“Configuring the Power Buttons” on page 3 - 8</a>).</p> <p><i>The screen controls need to be adjusted.</i> Toggle the screen control key combinations <b>Fn + F8/F9</b>. If you're connected to an external monitor, make sure it's plugged in and turned on. You should also check the monitor's own brightness and contrast controls.</p> <p><i>The computer is set for a different display.</i> Toggle the screen display key combination, <b>Fn + F7</b>. If an external monitor is connected, turn it on.</p> <p><i>The <b>screen saver</b> is activated.</i> Press any key or touch the <b>TouchPad</b>.</p>
<p>No image appears on the <b>external monitor</b> I have plugged in and powered on.</p>	<p><i>You haven't installed the video driver and configured it appropriately from the <b>Control Panel</b>.</i> See <a href="#">Appendix B</a> for instructions on installing and configuring the video driver.</p>

Problem	Possible Cause - Solution
You forget the <b>boot password</b> .	<i>If you forget the password, you may have to discharge the battery of the CMOS. Contact your service representative for help.</i>
 <p><b>Password Warning</b></p> <p>If you choose to set a boot password, <b>NEVER</b> forget your password. The consequences of this could be serious. If you cannot remember your boot password you must contact your vendor and you may lose all of the information on your hard disk.</p>	
The sound cannot be heard or the <b>volume is very low</b> .	<i>The volume might be set too low. Check the volume control in the <b>Volume Control Panel</b> in the Windows taskbar, or use the key combination <b>Fn + F5</b> and <b>F6</b> (see <b>“Function/Hot Key Indicators” on page 1 - 9</b>) to adjust.</i>
The CD/DVD <b>cannot be read</b> .	<i>The CD/DVD is dirty. Clean it with a CD/DVD cleaner kit.</i>
The CD/DVD <b>tray will not open</b> when there is a disc in the tray.	<i>The CD/DVD is not correctly placed in the tray. Gently try to remove the disc using the eject hole (see <b>“Loading Discs” on page 2 - 3</b>).</i>
The <b>DVD regional codes</b> can no longer be changed.	<i>The code has been changed the maximum <b>5</b> times. See <b>“DVD Regional Codes” on page 2 - 5</b>.</i>
<b>Unwelcome numbers</b> appear when typing.	<i>If the LED  is lit, then Num Lock is turned <b>ON</b>. (see <b>“LED Indicators” on page 1 - 6</b>).</i>

## Troubleshooting

Problem	Possible Cause - Solution
 <h3>Other Keyboards</h3> <p>If your keyboard is damaged or you just want to make a change, you can use any standard USB keyboard. The system will detect and enable it automatically. However special functions/hot keys unique to the system's regular keyboard may not work.</p>	
The <b>system freezes</b> or the screen goes dark.	<i>The system's power saving features have timed-out.</i> Use the AC/DC adapter, press the sleep ( <b>Fn + F4</b> ) key combination, or press the power button if no LEDs are lit.
The system never goes into a <b>power saving mode</b> .	Power Options features are not enabled. Go to the <b>Windows</b> Power Options menu and enable the features you prefer (see " <b>Power-Saving States</b> " on <a href="#">page 3 - 6</a> ). Make sure you have enabled <b>Hibernate</b> mode from the control panel.
The <b>Wireless LAN/Bluetooth/3.75G/HSPA</b> modules cannot be detected.	<i>The modules are off.</i> Check the LED indicator  and/or function key indicator to see if the WLAN/Bluetooth/3.75G/HSPA module is on or off (see " <b>LED Indicators</b> " on <a href="#">page 1 - 6</a> ). If the LED indicator is off, then press the <b>Fn + F11 (WLAN)</b> , <b>Fn + F12 (Bluetooth)</b> or <b>Fn +  (3.75G/HSPA)</b> key combination(s) in order to enable the modules (see <a href="#">Table 1 - 4, on page 1 - 9</a> ).

Problem	Possible Cause - Solution
The <b>PC Camera</b> module cannot be detected.	<i>The module is off.</i> Press the <b>Fn + F10</b> key combination in order to enable the module (see <b>“Function/Hot Key Indicators” on page 1 - 9</b> ). Run the <b>BisonCap</b> program to view the camera picture.
The <b>Wireless LAN/Bluetooth/ PC Camera/3.75G/HSPA</b> modules cannot be configured.	The driver(s) for the module(s) have not been installed. Make sure you have installed the driver for the appropriate module (see the instructions for the appropriate module in <b>“Modules &amp; Options” on page 7 - 1</b> ).
A file cannot be copied to/from a connected <b>Bluetooth</b> device.	<i>The transfer of data between the computer and a Bluetooth enabled device is supported in one direction only (simultaneous data transfer is not supported).</i> If you are copying a file from your computer to a Bluetooth enabled device, you will not be able to copy a file from the Bluetooth enabled device to your computer until the file transfer process from the computer has been completed
The <b>Bluetooth</b> module is <b>off</b> after resuming from Sleep.	<i>The Bluetooth module’s default state will be off after resuming from the Sleep power-saving state.</i> Use the key combination ( <b>Fn + F12</b> ) to power on the Bluetooth module after the computer resumes from Sleep.
The <b>Wireless LAN indicators</b>  show that the WLAN module is powered on, however the module does not connect.	<i>The WLAN module is turned off in the <b>Windows Mobility Center</b>.</i> The computer’s wireless function keys will not function properly if <b>Wireless</b> is turned <b>OFF</b> in the <b>Windows Mobility Center</b> control panel. Make sure that Wireless is <b>ON</b> in the Mobility Center to ensure proper function key behavior (see <b>“Windows Mobility Center” on page 7 - 6</b> ).

### Uninstalling the AMD AHCI Driver

Uninstalling the AMD AHCI driver is a two part process. Follow the instructions below if you need to uninstall the driver for any reason.

1. Go to the **Windows** control panel.
2. Click **Device Manager (Hardware and Sound > Devices and Printers)**.
3. Click the arrow next to **IDE ATA/ATAPI controllers** to open the sub-menu.
4. Double-click **AMD SATA controller**.
5. Click **Driver** (tab) and click **Uninstall**.
6. Click to select “**Delete the driver software for this device.**” and click **OK**.

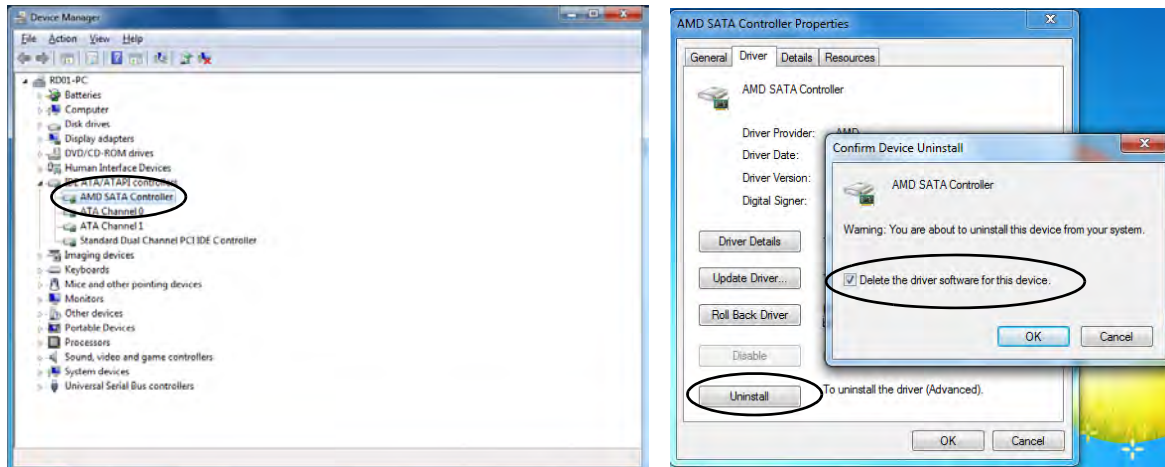

Figure 8 - 1 - Device Manager - Uninstall AMD SATA Controller



7. Click **Yes** to restart the computer.
8. Click **Restart Now** to restart the computer again.
9. After the computer has restarted return to the **Windows** control panel.
10. Click **Programs and Features (Programs)**.
11. Click **AMDSata** and click **Uninstall > Yes**.
12. Click **Finish** and close the control panel.

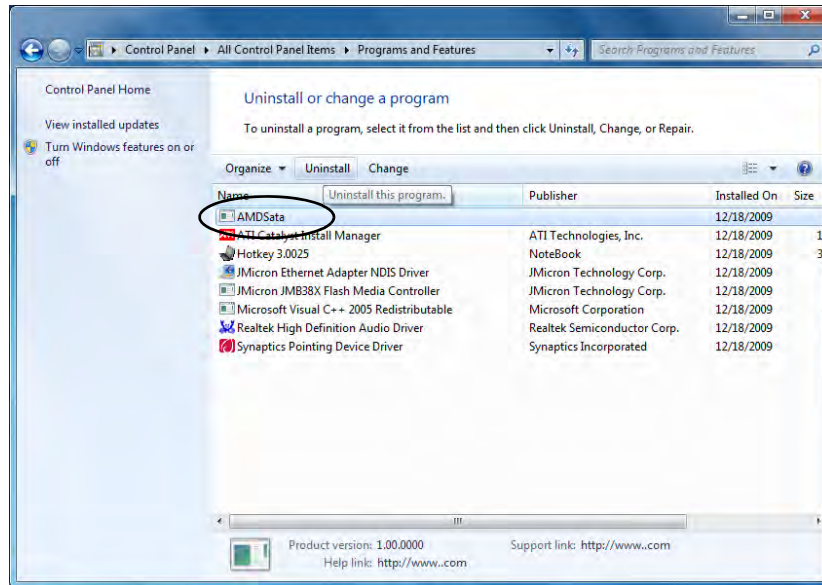

Figure 8 - 2 - Uninstall AMDSata (Programs and Features)

# Bluetooth Connection Problems

If you are experiencing problems connecting to some Bluetooth devices (in particular certain mobile phones and headsets) it may be necessary to download and install the **Windows Mobile Device Center** software (for *Windows Vista* and *Windows 7*). Go to the Microsoft website and search for the **Microsoft Windows Device Center Driver for Windows Vista (64-bit or 32-bit) and Windows 7 (64-bit or 32-bit)**, and then download the driver.

1. Install the **Microsoft Windows Device Center Driver** as appropriate for your operating system.
2. **Windows Vista** will automatically configure the driver for you, however **Windows 7** requires further configuration.
3. Make sure the Bluetooth device is powered on.
4. Go to the **Windows 7** control panel and double-click **Device Manager (Hardware and Sound > Devices and Printers)**.
5. **Bluetooth Peripheral Device(s)** will be listed under **Other Devices** (note this will only be listed if you have connected, or tried to connect to, a Bluetooth device previously).

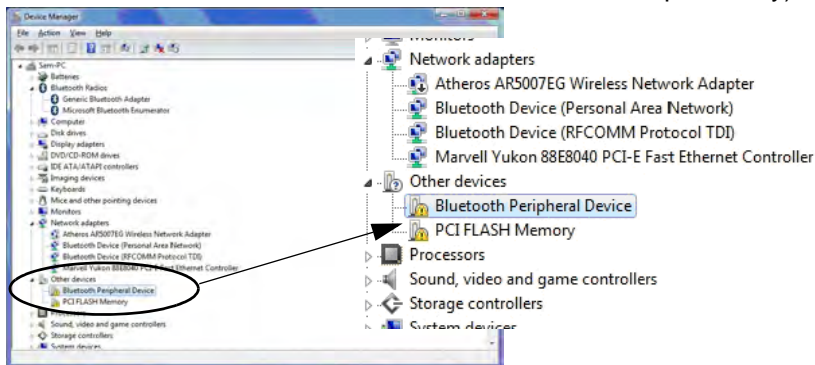

Figure 8 - 3 - Device Manager

### Bluetooth Peripheral Devices

You will need to repeat the procedure listed here for all **Bluetooth Peripheral Devices** listed under **Other Devices** i.e. until there are no more **Bluetooth Peripheral Devices** listed under this menu heading.

6. Right-click **Bluetooth Peripheral Device** and click on **Update Driver Software**.
7. Click **Browse my computer for driver software**.
8. Click **Let Me pick from a list of device drivers on my computer**.

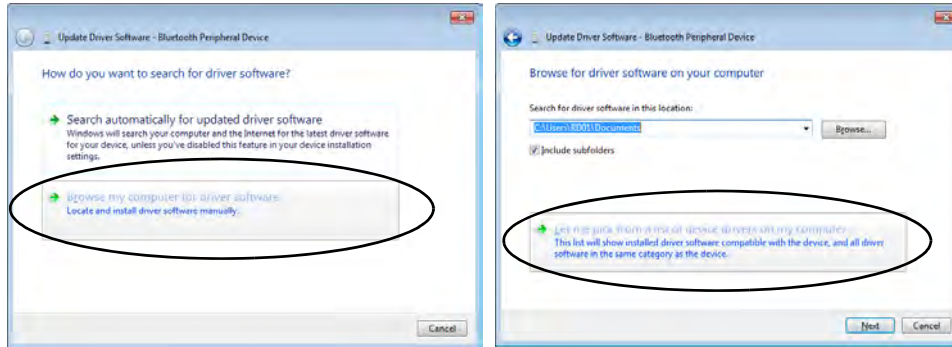

Figure 8 - 4 - Browse my computer.../Let me pick from...

9. Select **Bluetooth Radios** from the list.

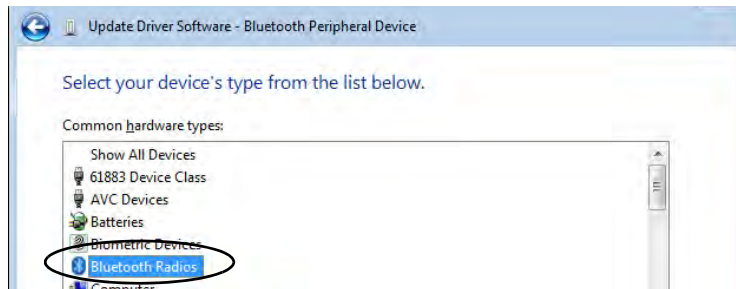

Figure 8 - 5 - Select Bluetooth Radios

## Troubleshooting

10. A list of drivers will appear with **Manufacturer** on one side and **Model** in the other.
11. Choose **Microsoft Corporation** (make sure you choose the full name **Microsoft Corporation** and do not choose **Microsoft** - Note that you must have installed the **Microsoft Windows Device Center Driver for Microsoft Corporation** to appear in the list).
12. Select **Windows Mobile-based device support** from the **Model** list.

8

Make sure you select  
**Microsoft Corporation**

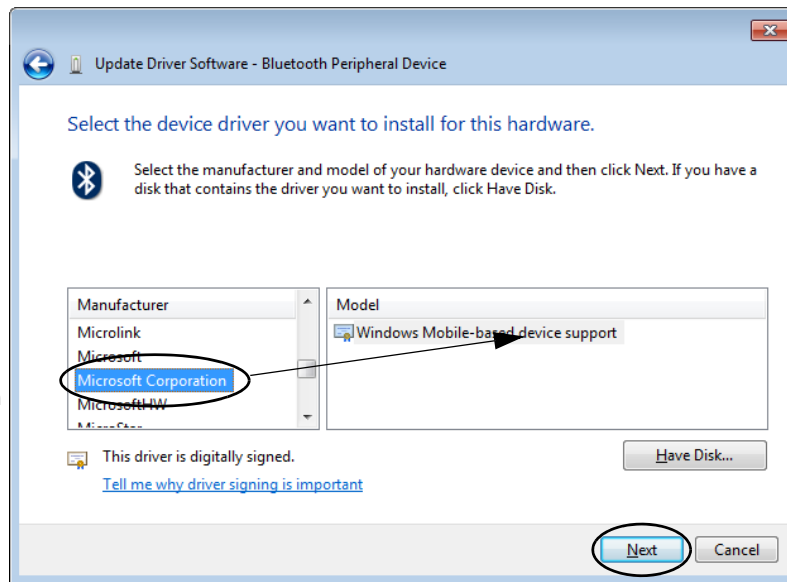
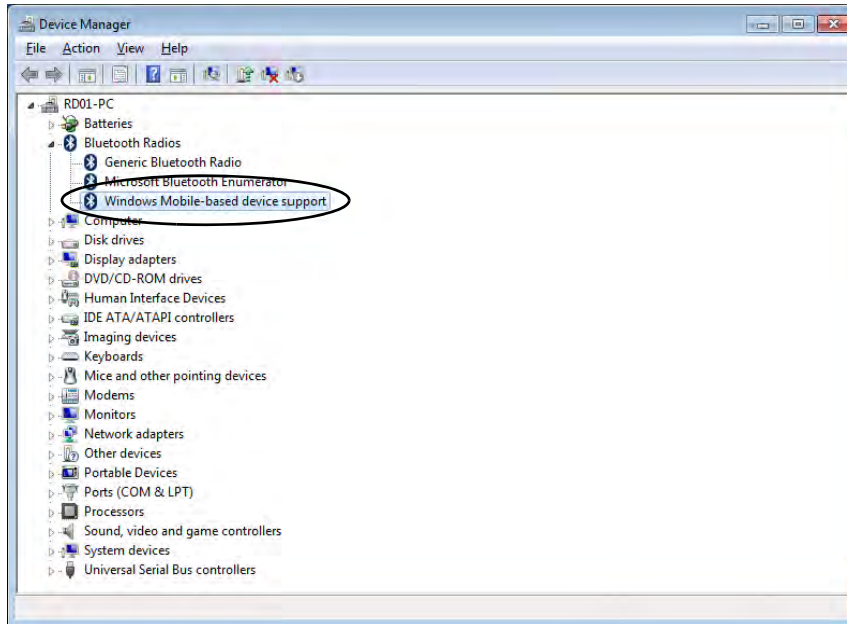

Figure 8 - 6 - Select Device Driver

13. Click **Next > Yes** and the driver will install.
14. Click **Close** to complete the installation.

15. The **Device Manager** should now display the **Windows Mobile-based device support** under **Bluetooth Radios**.
16. You will need to repeat the process for any other **Bluetooth Peripheral Devices** listed under **Other Devices**.



*Figure 8 - 7 - Device Manager - Bluetooth Radio*

# Wake On LAN Setup

Wake On LAN is an Ethernet computer networking standard that allows a computer to be turned on or woken up by a network message. If you need to have your computer **Wake On LAN** you will need to enable **Computer Management** settings as follows.

1. Go the **Windows** control panel and double-click **Administrative Tools (System and Security)**.
2. Double-click **Computer Management**.
3. Click **Device Manager** under **System Tools**, and click the arrow to the left of **Network adapters**.
4. Double-click **jMicron PCIExpress Fast Ethernet Adapter**, and click **Power Management** (tab).
5. Click to enable (place a check in the checkbox) "**Allow this device to wake the computer**".

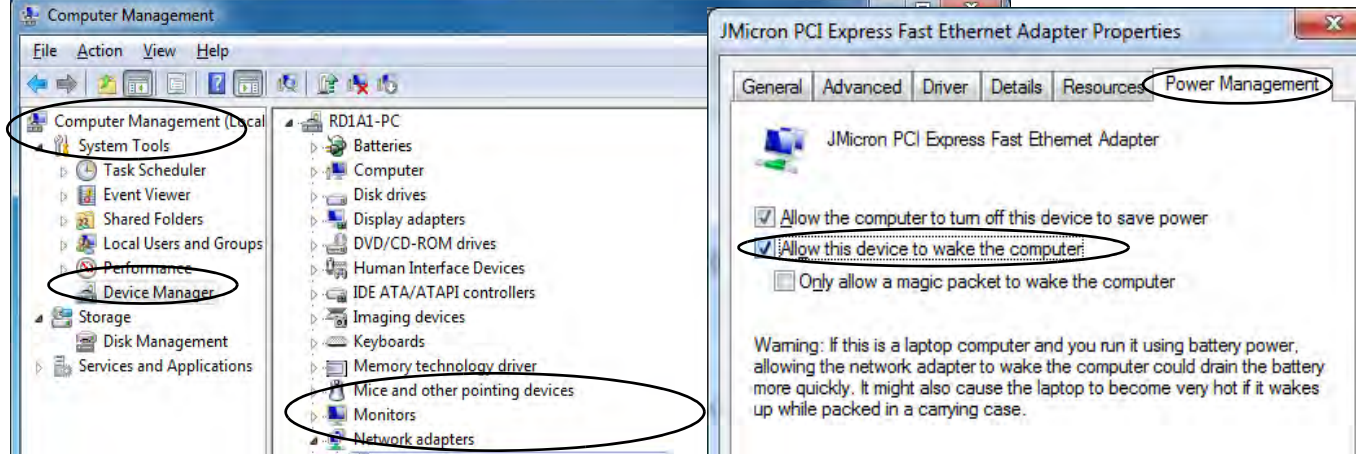

Figure 8 - 8- Network Adapter Wake On LAN (Power Management)

6. Click **Advanced** (tab).
7. Scroll down to the bottom of the **Property** menu and select “**Wakeup from Shutdown**”.
8. Click to select **Enabled** from the drop-down **Value** menu.
9. Click **OK** to close the menu.
10. Close the **Computer Management** control panel.

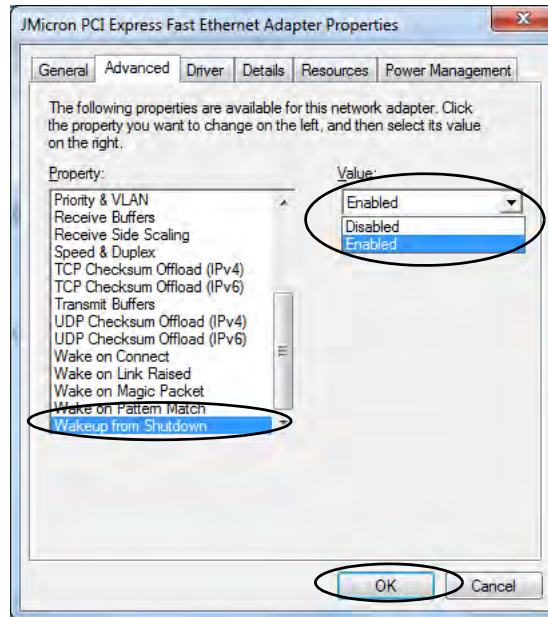

Figure 8 - 9- Network Adapter Wake On LAN (Advanced)









# Appendix A: Interface (Ports & Jacks)



## Overview

The following chapter will give a quick description of the interface (ports & jacks) which allow your computer to communicate with external devices, connect to the internet etc.

# Notebook Ports and Jacks

Item	Description
Card Reader Port	The card reader allows you to use some of the latest digital storage cards. Push the card into the slot and it will appear as a removable device.
DC-In Jack 	Plug the supplied AC/DC adapter into this jack to power your computer.
External Monitor (VGA) Port 	This port allows you to connect an external monitor, or Flat Panel Display, to get dual video or simultaneous display on the LCD and external monitor/FPD.
HDMI-Out Port <b>HDMI</b>	The HDMI-Out ( <b>High-Definition Multimedia Interface</b> ) is an audio/video connector interface for transmitting uncompressed digital streams. This allows you to connect an external monitor, TV or Flat Panel Display etc. as a display device by means of a HDMI cable. <b>Note that HDMI carries both audio and video signals.</b>
Headphone-Out Jack 	Headphones or speakers may be connected through this jack. <b>Note:</b> Set your system's volume to a reduced level before connecting to this jack.
Microphone-In Jack 	Plug an external microphone in to this jack to record on your computer.

A

Item	Description
RJ-45 LAN Jack 	This port supports LAN (Network) functions. <b>Note:</b> Broadband (e.g. ADSL) modems usually connect to the LAN port.
Security Lock Slot 	To prevent possible theft, a Kensington-type lock can be attached to this slot. Locks can be purchased at any computer store.
USB 2.0/1.1 Ports 	These USB 2.0 compatible ports (USB 2.0 is fully USB 1.1 compliant) are for low-speed peripherals such as keyboards, mice or scanners, and for high-speed peripherals such as external HDDs, digital video cameras or high-speed scanners etc. Devices can be plugged into the computer, and unplugged from the computer, without the need to turn the system off (if the power rating of your USB device is 500mA or above, make sure you use the power supply which comes with the device).

## Interface (Ports & Jacks)

A

# Appendix B: ATI Video Driver Controls

The basic settings for configuring the LCD are outlined in “*Video Features*” on [page 1 - 13](#).

## ATI Video Driver Installation

Make sure you install the drivers in the order indicated in [Table 4 - 1, on page 4 - 3](#). Insert the *Device Drivers & Utilities + User’s Manual* disc and click **Install Drivers** (button).

1. Click **1.Install Video Driver > Yes**.
2. Click **Next > Install** (button).
3. Click the **Express** (or **Custom** if you prefer to manually configure the driver installation settings) button and click **Next**.
4. Click **Accept** (button) and click **Yes**.
5. Click **Finish > Yes** to restart the computer.

**Note:** After installing the video driver go to the **Display/Display Settings** control panel to adjust the video settings to the highest resolution.



### Video Card Options

Note that card types, specifications and drivers are subject to continual updates and changes. Check with your service center for the latest details on video cards supported.



### ATI Taskbar Icon

The **ATI Catalyst Control Center** can be accessed as above or by double-clicking the icon  in the taskbar (or by right-clicking the icon and selecting **Catalyst Control Center**).

If you don't see the ATI icon in the taskbar, click **Options > Preferences** (tab) in the **ATI Catalyst® Control Center**, and select **Enable System Tray Menu** (see [Figure 1 - 8 on page 1 - 14](#)).

Right-click the ATI icon  to bring up the taskbar menu.

*Figure B - 1*

### ATI Catalyst Control Center Basic Settings

## ATI Catalyst® Control Center

Adjust the video settings from the **ATI Catalyst® Control Center**.

1. Open the **ATI Catalyst Control Center** (see page [1 - 13](#)).
2. Click **Advanced** (button).
3. A wizard will help you set up the display options, or you can click **Advanced** (button) to go to the **ATI Catalyst Control Center** (you can change the options from the **Basic** menu or the **View** menu in the ATI Catalyst Control Center).
4. Note that the **Advanced** options are featured in this chapter (if you choose **Basic** the on-screen Wizard will help you configure your display options)

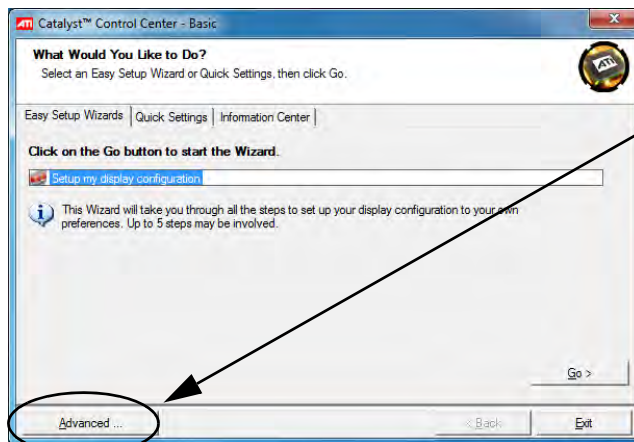

Click **Advanced** Button to go to the **ATI Catalyst Control Center**. You can change the options from **Advanced** to **Basic** by clicking the appropriate button.

Note that the control panels pictured in the following pages are from the **Advanced** settings.

The **ATI Catalyst® Control Center** provides additional video configuration controls and tools which allow quick access to features such as display options, 3D Settings, color and Help menus etc. Adjust settings from the **Graphics** and **Options** menus at the top of the control panel.

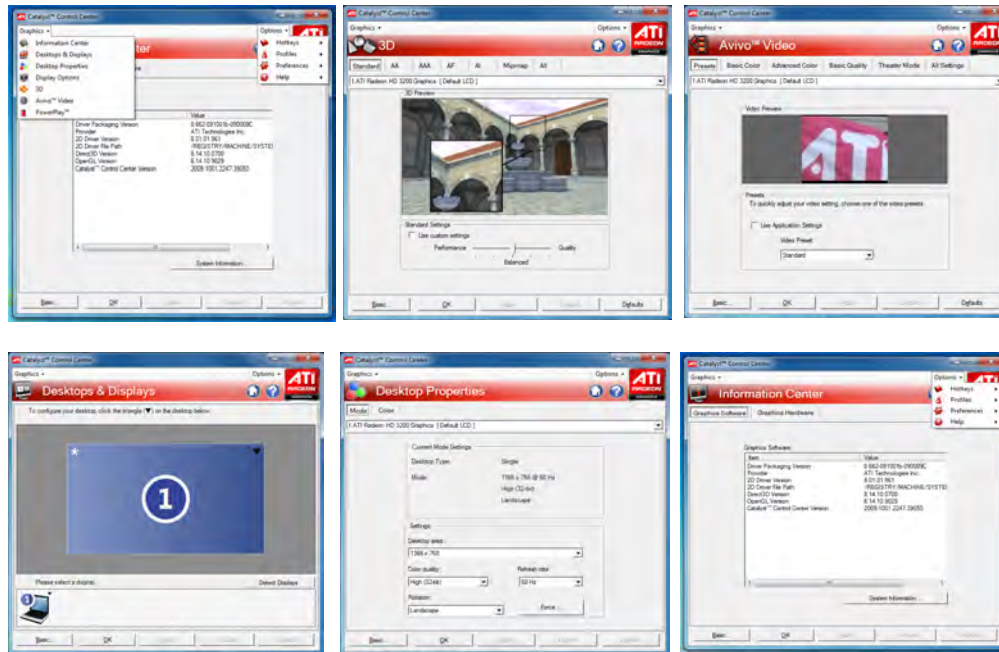

  
**Help Menus**

Click the **Help** icon  and select an option from the drop down menu. Press **F1** to bring up **Help** for any currently selected page.

*Figure B - 2*  
**ATI Catalyst Control Center Advanced Settings**

**B**



### Function Keys

You can use the **Fn + F7** key combination to toggle through the display options:

- Notebook Only
- External Display Only
- Notebook + External Display

Give the displays enough time to refresh.

### Other Applications

If you are using a third party application to play DVDs etc. you will need to consult the application's documentation to see the appropriate audio configuration (the application must support digital to analog translation).

## Attaching Other Displays

Besides the built-in LCD, you can also use an external monitor/flat panel display as your display device. The following are the display options:

- The built-in LCD.
- An external monitor connected to the external monitor port/HDMI-Out port.
- A flat panel display connected to the external monitor port/HDMI-Out port.

### HDMI Notes

- Connect a device with HDMI support to the HDMI-Out port **BEFORE** attempting to play audio/video sources through the device.

### HDMI Video Configuration

1. Connect an HDMI cable from the HDMI-Out port to your external display.
2. Configure your external display as per the instructions provided on the following pages.
3. Set up your external display (TV or LCD) for HDMI input (see your display device manual).
4. You can now play video/audio sources through your external display.

See *“HDMI Audio Configuration” on page B - 14* for more information on the audio settings for HDMI.



## Display Modes

### Single

Only one of your displays is used.

### Duplicate

Duplicate simply shows an exact copy of the Main display desktop on the other display(s). This mode will drive multiple displays with exactly the same content, resolution, refresh rates and color quality etc.

### Extend

Extend treats both connected displays as **separate** devices, and they act as a virtual desktop resulting in a large workspace. When a display is Extended, you can drag any icons or windows across to the other display desktop. It is therefore possible to have one program visible in one of the displays, and a different program visible in the other display.

## ATI Video Driver Controls



### Detect Displays

Click **Detect Displays** (button) to automatically update the attached display information.

## Configuring an External Display using the ATI CCC

You can use the **ATI Catalyst Control Center** to configure any attached displays.

1. Attach your external display to the external monitor port/HDMI-Out port and turn it on.
2. Open the **ATI Catalyst Control Center**.
3. Select **Desktops & Displays** from the **Graphics** menu in the top left of the screen.
4. Attached displays will appear in the lower part of the screen (click **Detect Displays** to find any attached displays that do not automatically appear).
5. Right-click the attached display icon to bring up the options.
6. Select an option from the menu, and click **Yes** to accept the settings.
7. Click **OK** to save the changes.

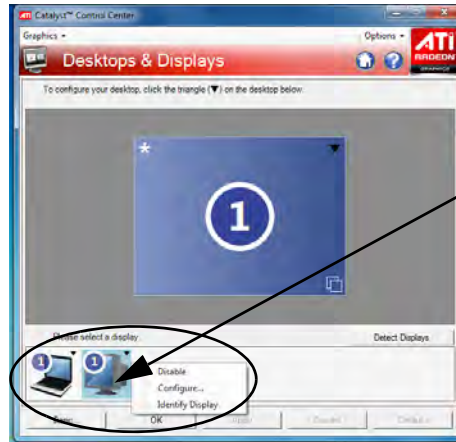

Attached displays will appear here.

*Figure B - 3*  
**Desktops &  
Displays**

**B**

## ATI CCC - Switching Display Modes

1. Attach your external display to the external monitor port/HDMI-Out port and turn it on.
2. Open the **ATI Catalyst Control Center**.
3. Select **Desktops & Displays** from the **Graphics** menu in the top left of the screen.
4. Attached displays will appear in the lower part of the screen (click **Detect Displays** to find any attached displays that do not automatically appear).
5. Right-click the attached external display icon and select **Disable**.
6. Click **Yes** to accept the settings.
7. After the external display has been disabled right-click the attached external display icon again.

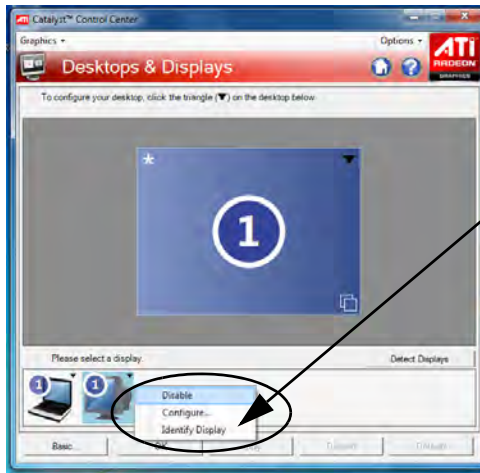

Right-click and  
select Disable.

*Figure B - 4*  
**Desktops &  
Displays (Disable)**

## ATI Video Driver Controls

8. Select Duplicate or Extend from the menu.
9. Click **Yes** to accept the settings.
10. If you need to change the display mode then disable the external display and configure as outlined here.

*Figure B - 5*  
**Desktops &  
Displays  
(Extend Mode)**

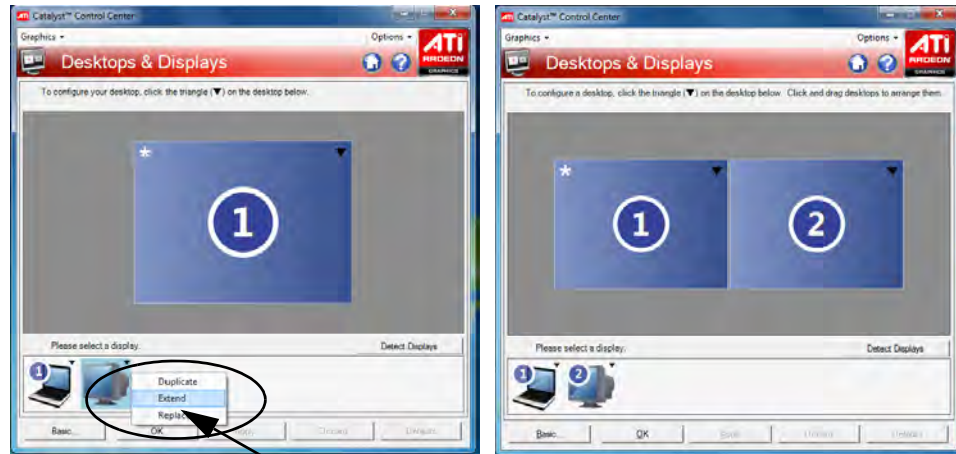

Right-click and select either Duplicate or Extend.

## Configuring an External Display in Win 7

1. Attach your external display to the external monitor port/HDMI-Out port and turn it on.
2. Go to the **Screen resolution** control panel (see “*Video Features*” on page 1 - 13).
3. Click the **Detect** button.
4. The computer will then detect any attached displays.

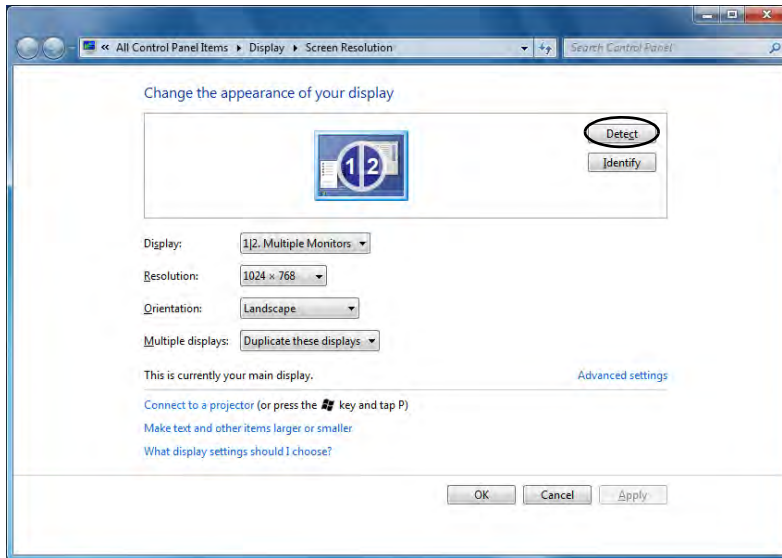

*Figure B - 6 -  
Screen Resolution  
Multiple Displays  
(Win 7)*

5. You can configure the displays from the **Multiple Displays** menu.

6. Click **Apply** to save any setting changes.

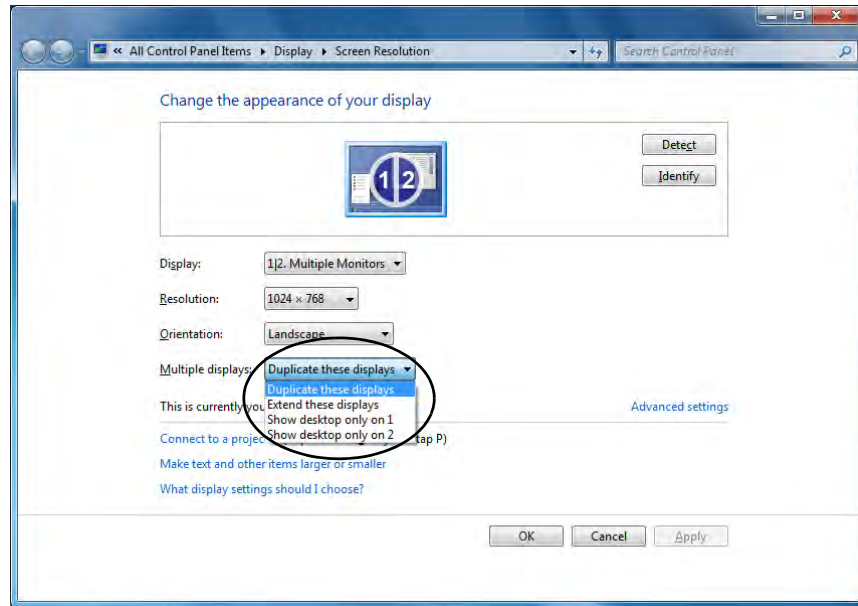



*Figure B - 7 -*  
**Screen Resolution**  
**Multiple Display**  
**Options**  
**(Win 7)**

- Duplicate these displays - Shows an exact copy of the main display desktop on the other display(s)
- Extend these displays - Treats both connected displays as **separate** devices
- Show desktop only on 1/2 - Only one of your displays is used.

## Using the Windows Logo Key + P Key Combination to Switch Displays

You can also use the  + **P** key combination to quickly change display configuration and modes (this is particularly useful when attaching a projector) in *Windows 7*.

1. Attach your external display to the external monitor port and turn it on.
2. Press the  + **P** key combination.
3. An on-screen menu will pop up.
4. Use the cursor keys (or  + **P**) to select the appropriate configuration from the menu, and press Enter to confirm the selection.



*Figure B - 8*  
 + P Display  
Configuration  
Selection  
(Win 7)

## Theater Mode

Theater Mode enables you to display video playback in full screen on a secondary monitor. Theater Mode can be configured from the **Avivo™ Video > Theater Mode** tab in the **Graphics Settings** Tree View pane.

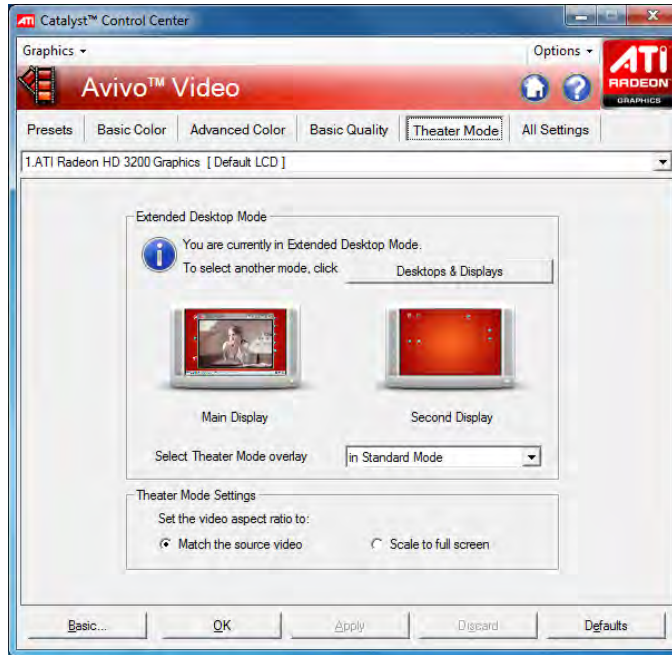
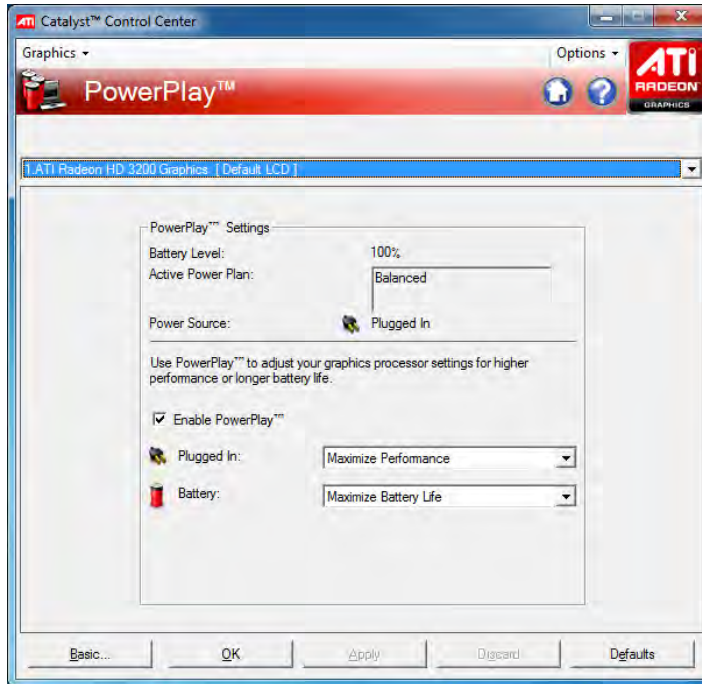

*Figure B - 9*  
**Theater Mode**



## PowerPlay™

PowerPlay™ in the ATI CCC allows you to set your graphics processor settings for higher performance or longer battery life.



*Figure B - 10*  
**PowerPlay™**

# HDMI Audio Configuration

HDMI (High-Definition Multimedia Interface) carries both **audio** and video signals. Configure the audio output as per the instructions below.

1. Connect a device with HDMI support to the HDMI-Out port.
2. Click **Start**, and click **Control Panel** (or point to **Settings** and click **Control Panel**).
3. Click **Sound** (Hardware and Sound), and click **Playback** (tab).
4. Click to select the connected HDMI device and click **Set Default** (or right-click the icon and select **Set as Default Device**).

*Figure B - 11*  
**Sound - HDMI Device (Set Default)**

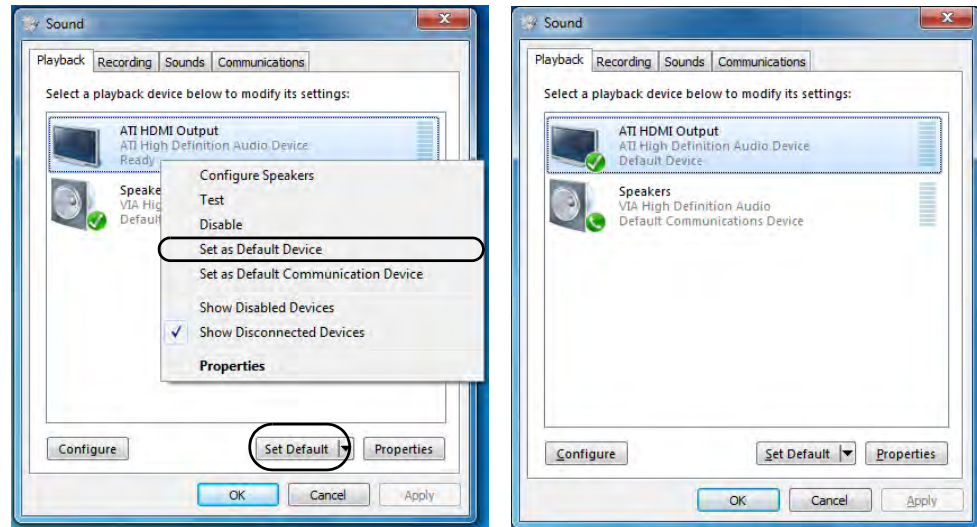

5. Double-click the connected HDMI device (or right-click and select **Properties**) to adjust the HDMI settings from the control panel tabs.
6. Click **OK** to close the control panel (see notes overleaf).

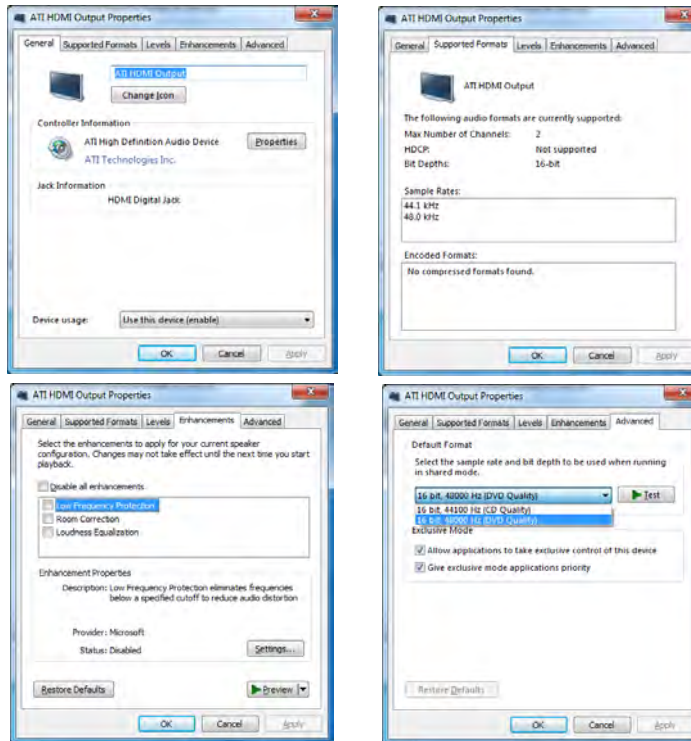

*Figure B - 12*  
**HDMI Device Properties**



### Other Applications

If you are using a third party application to play DVDs etc. from any attached DVD device, you will need to consult the application's documentation to see the appropriate audio configuration (the application must support digital to analog translation).

### HDMI Notes

- Connect a device with HDMI support to the HDMI-Out port **BEFORE** attempting to play audio/video sources through the device.
- To play audio sources through your external display's (TV or LCD) speakers you will need to go to the audio configuration control panel on the display and configure the audio input accordingly (see your display device manual).

### HDMI Video Configuration

1. Connect an HDMI cable from the HDMI-Out port to your external display.
2. Configure your external display as per the instructions in *“Attaching Other Displays” on page B - 4*.
3. Set up your external display (TV or LCD) for HDMI input (see your display device manual).
4. You can now play video/audio sources through your external display.

# Appendix C: Specifications



## Latest Specification Information

The specifications listed in this Appendix are correct at the time of going to press. Certain items (particularly processor types/speeds and CD/DVD device types) may be changed, updated or delayed due to the manufacturer's release schedule. Check with your service center for details.

## Specifications

Processor	Display	Storage
<p><b>AMD® Athlon™ x2 Dual Core Processor:</b>  <b>QL62 (2.0GHz)</b>                      65nm (65 Nanometer) Process Technology, 1MB L2 Cache &amp; 667MHz FSB - TDP 35W - (638-pin) Micro--PGA Package - Socket-S1G2</p> <p><b>AMD® Athlon™ Single Core Processor:</b>  <b>QI46 (2.1GHz)</b>                      65nm (65 Nanometer) Process Technology, 512KB L2 Cache &amp; 667MHz FSB - TDP 25W - (638-pin) Micro--PGA Package - Socket-S1G2</p> <p><b>AMD® Mobile Sempron™ Processor:</b>  <b>SI40 (2.0GHz)</b>                      65nm (65 Nanometer) Process Technology, 512KB L2 Cache &amp; 667MHz FSB - TDP 25W - (638-pin) Micro--PGA Package - Socket-S1G2</p>	<p>14.0" (35.56cm) 16:9 HD (1366 * 768) TFT LCD</p> <p><b>Memory</b></p> <p>Two 200 Pin SO-DIMM Sockets Supporting <b>DDRII (DDR2)</b> 800MHz (Real Frequency depends on the FSB of Processor)                      Memory Expandable up to <b>4GB</b> (using 1GB/2GB SO-DIMM Modules)</p> <p><b>Video</b></p> <p><b><u>ATI® Radeon HD3200 On Board Video:</u></b>                      High Preference 3D/2D Graphic Accelerator                      Shared Memory Architecture of up to 512MB                      Supports Microsoft DirectX® 10</p> <p><b>BIOS</b></p> <p>One 8Mb SPI Flash ROM                      Phoenix™ BIOS</p>	<p>One Changeable 12.7mm(h) Super Multi Optical Device Drive (CD/DVD) with SATA Interface                      One Changeable 2.5" 9.5 mm (h) HDD with SATA (Serial) Interface</p> <p><b>Audio</b></p> <p>High Definition Audio                      Direct Sound 3D™ Compatible                      Built-In Microphone                      2 * Built-In Speakers</p> <p><b>Keyboard &amp; Pointing Device</b></p> <p>Isolated WinKey Keyboard                      Built-in TouchPad with Multi-Gesture Functionality</p>
Core Logic		
ATI® RS780MN + SB710		

Interface	Slots	Communication
<p>Three USB 2.0 Ports            One External Monitor Port            One HDMI-Out Port            One Headphone-Out Jack            One Microphone-In Jack            One RJ-45 LAN Jack            One DC-In Jack</p>	<p><b><u>Two Mini-Card Slots with PCIe (Slot 1) &amp; USB (Slot 2) interface:</u></b></p> <p>Slot 1 for Half Mini-Card WLAN Module            Slot 2 for 3.75G Mini-Card Module  <b>(Factory Option)</b></p>	<p><b><u>3.75G Module:</u></b>            UMTS/HSPDA-based 3.75G Module with USB Mini-Card Interface <b>(Factory Option)</b>            Quad-band GSM/GPRS (850 MHz, 900 MHz, 1800 MHz, 1900 MHz)            UMTS WCDMA FDD (2100 MHz)  <b>Note that UMTS modes CAN NOT be used in North America</b></p>
Card Reader	Communication	Power Management
<p>Embedded Multi-In-1 Card Reader</p> <ul style="list-style-type: none"> <li>- MMC / RSMCC</li> <li>- SD / Mini SD</li> <li>- MS / MS Pro / MS Duo</li> </ul> <p><b>Note:</b> Some of these cards require PC adapters that are usually supplied with the cards.</p>	<p>Built-In 10Mb/100Mb Base-TX Ethernet LAN</p> <p>3rd Party WLAN 802.11b/g/n Half Mini-Card Module with PCIe Interface<b>(Option)</b></p> <p>300K Pixel PC Camera Module with USB interface <b>(Factory Option)</b></p> <p>1.3M Pixel PC Camera Module with USB interface <b>(Factory Option)</b></p> <p>Bluetooth 2.1 + EDR (Enhanced Data Rate) Module <b>(Factory Option)</b></p> <p><b>Combo WLAN (802.11b/g/n) and Bluetooth v3.0</b> Half Mini-Card Module with PCIe Interface <b>(Factory Option)</b></p>	<p>Supports Wake on LAN            Supports Wake on USB</p>
		Power
		<p>Full Range AC/DC Adapter            AC input 100 - 240V, 50 - 60Hz,            DC Output 19V, 3.42A or 18.5V, 3.5A <b>(65 Watts)</b></p> <p>Removable 6 Cell Smart Lithium Ion Battery Pack 48.84WH</p> <p>2nd Battery 6 Cell Smart Lithium Ion Battery Pack 62.16WH <b>(Option)</b></p>



## Specifications

Security	
Security (Kensington® Type) Lock Slot BIOS Password	
Operating System	
Windows® 7	
Environmental Spec	
Temperature	
Operating:	5°C - 35°C
Non-Operating:	-20°C - 60°C
Relative Humidity	
Operating:	20% - 80%
Non-Operating:	10% - 90%
Dimensions & Weight	
340mm (w) * 238mm (d) * 13.9 - 31.8mm (h) 2.2 kg with 6 Cell Battery Pack	