

## About this User's Manual

This user's manual is designed to let you easily find the information you need to get the most from your notebook.

- Introduces you to the features of your notebook.
- Gives you the useful details on using your notebook.
- Tells you how to look after your notebook, whether at home or traveling.
- Talks about Express Card peripherals and how to use them.
- Goes into more detail about power management and explains how to conserve power while on the move.
- Introduces you to BIOS, the nervous system of your notebook, and how to change its fundamental settings.

There is no need to read the manual from the beginning to end. Simply find your way to the section that interests you using the table of contents, or browse through the manual.

You will come across the following icons in this manual:



Helpful pointers and tricks to get more from your notebook



To help you note and avoid possible damage to your notebook's hardware or software, or loss of your work





Points out possible damage to property, personal injury or death

Information in this document is subject to change without notice.

© Compal Electronics, Inc. 2009. All rights reserved.

Trademarks used in this document: Microsoft and Windows are registered trademarks of Microsoft Corporation.

Other trademarks and trade names may be used in this document to refer to either the entities claiming the marks and names or their products

About this User's Manual .....	1
Safety Instructions .....	a
Specifications.....	i
Chapter 1 Introducing Your Notebook.....	①
<b>1.1 Front Side</b> .....	<b>1-1</b>
1.1.1 Camera.....	1-2
1.1.2 WOW Video Button.....	1-2
1.1.3 WOW Audio Button .....	1-2
1.1.4 Smart Key Button .....	1-2
1.1.5 Num Lock (Blue) .....	1-2
1.1.6 Caps Lock (Blue) .....	1-2
1.1.7 Power Buttons.....	1-2
1.1.8 Power USB Button.....	1-2
1.1.9 Fingerprint.....	1-3
1.1.10 TP Disable (Blue) .....	1-3
1.1.11 Power LED (Blue) .....	1-3
1.1.12 Battery LED (Blue/Amber) (  ) .....	1-3
1.1.13 HDD accessing state Blue LED (  ) .....	1-3
1.1.14 Bluetooth/Wireless Switch LED .....	1-3
<b>1.2 Right Side</b> .....	<b>1-5</b>
1.2.1 Power USB Port .....	1-5
1.2.2 RF in.....	1-6
1.2.3 Optical Disc Drive.....	1-6
1.2.4 AC Adapter Connector .....	1-6
<b>1.3 Left Side</b> .....	<b>1-7</b>
1.3.1 Kensington Lock .....	1-7
1.3.2 Power USB Port .....	1-8
1.3.3 LAN Jack.....	1-8
1.3.4 HDMI Port .....	1-8
<b>1.4 Bottom Side</b> .....	<b>1-9</b>
1.4.1 Battery Pack .....	1-10
1.4.2 Battery Release Latch.....	1-10
Chapter 2 Operating Your Notebook (Windows 7) .....	②
<b>2.1 Turning Your Notebook On and Off</b> .....	<b>2-1</b>
2.1.1 Turning Your Notebook On.....	2-2
2.1.2 Turning Your Notebook Off .....	2-2

2.1.3 Logging Off.....	2-2
2.1.4 Adding User Accounts.....	2-3
2.1.5 Sleep Mode.....	2-3
<b>2.2 Tips for Using Windows .....</b>	<b>2-4</b>
2.2.1 Microsoft Windows 7 Help.....	2-5
2.2.2 Windows Desktop.....	2-6
2.2.3 Start Button.....	2-7
2.2.4 Taskbar .....	2-7
2.2.5 Notification Area (System Tray).....	2-8
2.2.6 Recycle Bin .....	2-8
2.2.7 Control Panel .....	2-8
2.2.8 Computer.....	2-9
<b>2.3 Keyboard and Touch Pad .....</b>	<b>2-10</b>
2.3.1 Numeric Keypad .....	2-11
2.3.2 Keyboard Shortcuts .....	2-11
2.3.3 Windows Logo Key Functions.....	2-12
2.3.4 Sticky Keys.....	2-13
2.3.5 Touch Pad Area .....	2-15
2.3.6 Customizing the Touch Pad .....	2-15
<b>2.4 Personalizing Your Desktop.....</b>	<b>2-16</b>
2.4.1 Choosing a Wallpaper.....	2-17
2.4.2 Choosing a Screen Saver .....	2-17
2.4.3 Choosing a Desktop Theme.....	2-17
2.4.4 Creating a Shortcut on the Desktop.....	2-17
<b>2.5 Display.....</b>	<b>2-18</b>
2.5.1 Adjusting the Brightness.....	2-19
2.5.2 Using an External Monitor .....	2-19
2.5.3 Setting the Display Resolution.....	2-19
<b>2.6 Networks .....</b>	<b>2-20</b>
<b>2.7 Managing Programs .....</b>	<b>2-21</b>
2.7.1 Running Programs.....	2-22
2.7.2 Adding Software .....	2-22
2.7.3 Removing Software .....	2-23
<b>2.8 Managing Files.....</b>	<b>2-24</b>
2.8.1 Updating Antivirus Software.....	2-25
2.8.2 Backing Up Files .....	2-25
2.8.3 Finding Files.....	2-25

---

2.8.4 Copying a File on the Hard Drive .....	2-25
2.8.5 Renaming Files .....	2-25
2.8.6 Deleting Files .....	2-26
2.8.7 Emptying the Recycle Bin .....	2-26
2.8.8 Retrieving Files From the Recycle Bin .....	2-26
<b>2.9 Playing Movies .....</b>	<b>2-27</b>
2.9.1 Adjusting the Volume .....	2-28
2.9.2 Adjusting the Picture .....	2-28
<b>Chapter 3 Innovative Product Feature .....</b>	<b>③</b>
<b>3.1 Easy Logon .....</b>	<b>3-5</b>
3.1.1 Program DJ .....	3-5
<b>3.2 Power Control .....</b>	<b>3-7</b>
3.2.1 Green Charger .....	3-7
<b>3.3 Joyful Experience .....</b>	<b>3-9</b>
3.3.1 WOW Audio .....	3-9
3.3.2 WOW Video .....	3-10
<b>3.4 Depth Security Control .....</b>	<b>3-12</b>
3.4.1 Entrance Guard .....	3-12
3.4.2 Smart Watchdog .....	3-17
3.4.3 Safety Guard .....	3-19
<b>3.5 User Friendly .....</b>	<b>3-23</b>
3.5.1 Wireless Switch .....	3-23
<b>3.6 Project communication .....</b>	<b>3-24</b>
3.6.1 EzRemote .....	3-24
3.6.2 EzTube .....	3-28
<b>Chapter 4 Caring for Your Notebook .....</b>	<b>④</b>
<b>4.1 Caring for Your Notebook .....</b>	<b>4-1</b>
4.1.1 Cleaning Your Notebook and Keyboard .....	4-2
4.1.2 Cleaning the Display .....	4-2
4.1.3 Cleaning the Touch Pad .....	4-2
4.1.4 Cleaning the CD/DVD Drive .....	4-2
4.1.5 Precautions .....	4-3
<b>4.2 Traveling .....</b>	<b>4-4</b>
4.2.1 Identifying Your Notebook .....	4-5
4.2.2 Packing Your Notebook .....	4-5

4.2.3 Travel Tips .....	4-5
4.2.4 If Your Notebook is Lost or Stolen .....	4-6
<b>Chapter 5 Peripherals .....</b>	<b>⑤</b>
5.1 Adding and Removing SD/MMC/MS Cards .....	5-1
5.2 Memory Modules .....	5-2
<b>Chapter 6 The Power System (Windows 7) .....</b>	<b>⑥</b>
6.1 Power Management .....	6-1
6.1.1 Managing Your Notebook's Power .....	6-2
6.1.2 Power Management Modes .....	6-2
6.1.3 Power Options Properties .....	6-3
6.1.4 Speed Step .....	6-4
<b>6.2 Battery .....</b>	<b>6-6</b>
6.2.1 Battery Performance .....	6-7
6.2.2 Checking the Battery Charge .....	6-7
6.2.3 Power Meter .....	6-7
6.2.4 Low-Battery Warning .....	6-7
6.2.5 Charging the Battery .....	6-8
6.2.6 Low-Battery Warning .....	6-8
6.2.7 Removing the Battery .....	6-8
6.2.8 Installing a Battery .....	6-9
6.2.9 Storing a Battery .....	6-9
6.2.10 Working With Extra Battery Packs .....	6-9
6.2.11 Maximizing Battery Life .....	6-9
<b>Chapter 7 The BIOS Setup Program .....</b>	<b>⑦</b>
7.1 Introduction .....	7-1
7.2 Navigating through the BIOS Setup Program .....	7-2
7.2.1 Accessing the BIOS Setup Program .....	7-4
7.2.2 Launching Submenus .....	7-5
7.2.3 Saving Changes and Exiting the Setup Program .....	7-5
<b>7.3 The Main Menu .....</b>	<b>7-6</b>
<b>7.4 The Security Menu .....</b>	<b>7-8</b>
<b>7.5 The Boot Menu .....</b>	<b>7-10</b>
<b>7.6 The Exit Menu .....</b>	<b>7-11</b>



## Safety Instructions

Use the following safety guidelines to help protect yourself and your notebook.

### ***General Warnings***

- Do not operate your portable computer for an extended period of time with the base resting directly on your body. With extended operation, heat can potentially build up in the base. Allowing sustained contact with the skin could cause discomfort or, eventually, a burn.
- Do not attempt to service the computer yourself. Always follow installation instructions closely.
- To avoid personal injury from electric shock or fire:
  - Completely power down the computer when replacing memory modules, cleaning the computer, its components, or chassis, or performing operations requiring similar steps. To do this, first turn the power off at the power switch, remove the battery, and then disconnect the AC adapter from the electrical outlet or from any other type of external power source, such as an external battery.
  - Do not operate the computer near water, for example, near a bathtub, kitchen sink or laundry tub, in a wet basement, by a swimming pool, or in the rain.
  - Do not connect or disconnect any cables or perform maintenance or reconfiguration of this product during an electrical storm.
  - Avoid using the wired modem or LAN during an electrical storm, as a remote risk of electric shock from lightning exists.
  - Do not push objects into the air vents or openings of your notebook or accessories. Doing so can short out interior components and may cause fire or electric shock.
  - When installing memory modules, ground you by touching a grounded conductive surface, such as a device with a grounded plug. Avoid touching the pins and leads on the memory module or internal circuitry of the computer.
- When setting up the computer for work, place it on a level surface.
- Handle components with care. Hold a component such as a memory module by its edges, not its pins.
- If the battery pack leaks and the fluid enter your eyes, do not rub them. Instead, rinse your eyes with clean running water and immediately seek medical attention. Otherwise, eye injury may be resulted.

- If acid leaking from the battery pack contacts your skin or clothing, immediately wash it away with running water. Otherwise, skin inflammation may occur.
- Operate the computer at the recommended temperature range of +5°C to +35°C (+41°F to +95°F). Store it at a temperature of -20°C to +60°C (+4°F to +140°F).
- Your notebook shipped with the plastic dummies installed in PCMCIA or Express Card. Dummies protect unused slots from dust, metal object, or other particles. Save the dummy for use when no PCMCIA or Express Card is installed in the slot.

### ***Power Cord & Adapter Warnings***

- See the installation instructions before connecting to the power supply.
- Use only the power cord indicated in this manual.
- Power cord sets for use in other countries must meet the requirements of that country. Use the appropriate AC adapter and power cord for your locale.
- If you use an extension cord with your AC adapter, ensure that the total ampere rating of the products plugged into the extension cord does not exceed the ampere rating of the extension cable.
- When using your power cord, make sure to position it around objects so it will not be cut or punctured.
- When you disconnect a cable, pull on its connector by its strain relief loop, not on the cable itself. As you pull out the connector, keep it evenly aligned to avoid bending any connector pins. Also, before you connect a cable make sure both connectors are correctly oriented and aligned.
- Be sure that nothing rests on your AC adapter's power cable and that the cable is not located where it can be tripped over or stepped on.
- Use only the AC adapters that are approved for use with this computer. Use of another type of adapter may risk fire or explosion.
- Before you connect the computer to a power source, ensure that the voltage rating of the AC adapter matches that of the available power source.
  - 115 V/60 Hz in most of North and South America and some Far Eastern countries such as South Korea and Taiwan.
  - 100 V/50 Hz in eastern Japan and 100 V/60Hz in western Japan.
  - 230 V/50 Hz in most of Europe, the Middle East, and the Far East.
  - If you use an extension cable with your AC adapter, ensure that the total ampere rating of the products plugged in to the extension cable does not exceed the ampere rating of the extension cable.
- Place the AC adapter in a ventilated area, such as a desktop or on the floor, when you use it to run the computer or to charge the battery. Do not cover the AC



adapter with papers or other items that will affect its cooling; also, do not use the AC adapter while it is inside a carrying case.

- Disconnect power cords and cables by grasping the connector, not by pulling on the cable itself. As you pull out the connector, keep it evenly aligned to avoid bending any connector pins. Before you connect a cable, please make sure both connectors are correctly aligned.
- To remove power from the computer, turn it off, remove the battery, and disconnect the AC adapter from the electrical outlet.

### ***Battery Pack Warnings***

- Do not carry a battery in your pocket, purse, or other container where metal objects (such as car keys) could short-circuit the battery terminals. The resulting excessive current flow can cause extremely high temperatures and may result in damage from burns.
- Danger of explosion may occur if battery is incorrectly replaced. Replace only with the same or equivalent type battery recommended by the manufacturer.
- Do not dispose of batteries in a fire. They may explode. Check with local authorities for disposal instructions.
- Do not use or leave the battery pack near a heat source. Heat can melt the insulation and damage other safety features, possibly leading it to leak acid, overheat, emit smoke, burst and/or ignite.
- Do not immerse the battery pack in water or allow it to get wet. Its protective features can be damaged. Abnormal chemical reactions may occur, possibly leading it to leak acid, overheat, emit smoke, burst and/or ignite.
- Do not crush, disassemble, puncture, or incinerate the short external contacts of a battery pack.
- Do not connect the positive (+) and negative (-) terminals with a metal object such as a wire. Short-circuiting may occur, leading the battery pack to leak acid, overheat, emit smoke, burst and/or ignite.
- Do not use an apparently deformed or damaged battery pack, which may leak acid, overheat, emit smoke, burst and/or ignite.
- If the battery pack leaks, gives off a bad odor, generates heat, becomes discolored or deformed, or in any way appears abnormal during use, recharging or storage, immediately remove it from the computer or charger and stop using it.

### ***Battery Pack Disposal***

- Dispose of the lithium ion battery packs at approved disposal sites only. To locate an appropriate site, contact the solid waste disposal officials where you live or look for a rechargeable battery recycling website that lists disposal locations near you.
- Do not dispose of battery packs in a fire, throw them in a trash receptacle, put them in a recycling bin not intended for their disposal, or otherwise discard them in a manner that may result in their being hazardous to the environment.

### ***Important Safety Instructions***

Read these instructions carefully and save them for future reference.

1. Follow all warnings and instructions given to you for this product.
2. Unplug this product from the wall outlet before cleaning. Do not use liquid cleaners or aerosol cleaners. Use a damp cloth for cleaning.
3. Do not use this product near water.
4. Do not place this product on an unstable cart, stand, or table.
5. Slots and openings on the back or bottom are provided for ventilation. To ensure reliable operation of the product and to protect it from overheating, do not block or cover these openings. Avoid placing the product on a bed, sofa, rug, or similar surface to prevent from blocking these openings. This product should never be placed near or over a radiator or a heat register, or in an enclosure unless proper ventilation is provided.
6. This product should be operated from the type of power indicated on the marking label. If you are not sure the type of power available, consult your dealer or local power company.
7. Do not allow anything to rest on the power cord. Do not locate this product where people will step on the cord.
8. If an extension cord is used with this product, make sure that the total ampere rating of the equipment plugged into the extension cord does not exceed the extension cord ampere rating. Also, make sure that the total rating of all products plugged into the wall outlet does not exceed the fuse rating.
9. Never push objects of any kind into this product through its cabinet slots as they may touch dangerous voltage points or short-out parts that could result in a fire or electric shock. Never spill any kind of liquid on the product.
10. Do not attempt to service this product by yourself. As opening or removing covers, you will be exposed to the dangerous voltages or other risks. Refer all servicing to qualified service personnel.
11. Unplug this product from the wall outlet and refer servicing to qualified service personnel under the following conditions:
  - a. When the power cord or plug is damaged or frayed.
  - b. As liquid is spilled into the product.
  - c. The product is exposed to rain or water.
  - d. If the product does not operate normally when the operating instructions are followed, adjust only those controls that are covered by the operating instructions. Improper adjustment of other controls may result in damage and will often require extensive work by a qualified technician to restore the product to normal condition.

### **Canadian Notice (Canada Only)**

This digital apparatus does not exceed the Class B limits for radio noise emissions from digital apparatus as set out in the Radio Interference Regulation of the Canadian Department of Communications.

This Class B digital apparatus complies with Canadian ICES-003.

Cet appareil numérique de la classe B est conforme à la norme NMB-003 du Canada.

### **Norwegian Notice (Norway Only)**

For Class I equipment: In Norway, it intend to be connected to CABLE DISTRIBUTION SYSTEMS, the screen of a coax cable is required to be galvanic isolated from the protective earth. The Norwegian text is that "Må kun tilkoples kabel-TV nett via galvanisk isolator."

### **CE Notice (European Union)**

#### **EU Declaration of Conformity**

The product conforms to the following standards:

Supplementary Information: "The product complies with the requirements of the Low Voltage Directive 73/23/EEC and the EMC Directive 89/336/EEC and/or the R&TTE Directive 1999/05/EEC."



This product is carrying the CE-Mark in accordance with the related European Directives.

### **BSMI Notice (Taiwan Only)**

Most Compal computer products are classified by the Bureau of Standards, Meteorology and Inspection (BSMI) as Class B information technology equipment (ITE).



R 31199

This (marked on the product) indicates the product complies with the BSMI standard.

### **BSMI 通告 (僅限於台灣地區)**

如果您在電腦的底部，側面或背面板上找到一個



標誌，則適用於以下部份

的相關規定：

此設備經測試證明符合BSMI(經濟部標準檢驗局)之乙類數位裝置的限定規定。這些限制的目的是為了在住宅區安裝時，能防止有害的干擾，提供合理的保護。此設備會產生，使用並散發射頻能量；如果未遵照製造廠商的指導手冊來安裝和使用，可能會干擾無線電通訊。但是，這並不保證在個別的安裝中不會產生干擾。您可以透過關閉和開啓此設備來判斷它是否會對廣播和電視收訊造成干擾；如果確實如此，我們建議您嘗試以下列一種或多種方法來排除干擾：

- 重新調整天線的接收方向或重新放置接收天線。
- 增加設備與接收器的距離。
- 將設備連接至不同的插座，使設備與接收器連接在不同的電路上。
- 請向經銷商或有經驗的無線電/電視技術人員查詢，以獲得幫助。

### **Safety of TV Tuner**

Note to CATV System Installer - This reminder is provided to call the CATV systems installer's attention to Section 820-93 of the National Electric Code which provide guidelines for proper grounding and, in particular, specify that the Coaxial cable shield be connected to the grounding system of the building as close to the point of cable entry as practical.



## Specifications

### CPU

- Intel Clarksfield (1.73G/1.6G 45nm 45W)

### Chipset

- Intel Ixex-Peak (PM55)

### Memory

- Clarksfield Support DDR-3 1066/1333MHz
- 1GB/2GB/4GB modules
- Easy upgrade from bottom side for two SODIMM, Max.8GB

### Display

- 15.6" 16:9 W W/LED HD Glare 1366x768
- 15.6"W W/LED Full HD 1920\*1080
- LED Backlight

### Hard Disk Drive (HDD)

- 9.5mm, 2.5" SATA HDD (5400rpm/7200rpm )

### Optical Disc Drive (ODD)

- Fixed 12.7mm height (SATA)
- DVD Super-Multi (DVD-RAM/-R/-RW/+R/+RW), 8X write
- CD-R/CD-RW/DVD-RAM/-R/-RW/+R/+RW writable
- Support Double Layer Recording is required
- High Definition Disc
- Blue-ray Combo DVD

### Graphics Chip

- ATI Madison 128 bits, DDR3 64Mx16\*8 (1G)

### Audio

- HD Audio
- 2 x Speakers, Microphone-in and headphone-out
- 2 x Internal Microphone support

### Communication

- LAN: 10/100, 1000 LAN
- Wireless LAN: 802.11 a/b/g/n via Mini-Card (option)
- Bluetooth: with USB2.0 interface (option)

### Keyboard

- 86/87 keys support with 101/102 key emulation without stick-point
- Windows key, Application key
- Standard pitch, 2.5+/-0.2 mm travel length

- Multi-Language support

### **Pointing Device**

- Touchpad with up/down scroll zone and two buttons

### **Flash card reader**

- 3-in-1 Card Reader (SD, MMC, MS), don't support XD card

### **I/O Ports**

- USB 2.0 x 4, Power USB x 4, HDMI x 1
- RGB: VGA port x 1
- Microphone-in x 1, Headphone-out x 1, CIR, DC-in jack
- Kensington lock x 1
- 3-in-1 Flash Card Reader (SD/MMC/MS) x 1
- Internal microphone x 2
- TV Tuner RF Antenna (Option)

### **Camera**

- 2.0M Pixel CMOS Camera w/ USB2.0 interface

### **TV tuner**

- Analog/Digital TV in Mini Card (option)
- Remote controller

### **System Status Indicators**

- 2 K/B indicators: Caps Lock, and Num Lock
- 1 Power Button LED
- 1 LED for IDE HDD activity
- 1 LED for System status (Power On / Suspend) (Blue)
- 1 LED for Battery status (Charging / Full / L1 / L2)
- 1 LED for Blue tooth/Wireless Card
- 1 LED for TP Button Disable (Blue/Enabled)
- 1 LED for Power USB (Blue)
- 1 LED for WoW Audio (Blue)
- 1 LED for WoW Video (Blue)
- 1 LED for Smart Key (Blue)

### **Control buttons**

- Power button (support software off, 4 sec) x 1
- Magnetic lid switch control for system standby/wakeup
- One Switch to On/Off Wireless Device for wireless control
- Control buttons for Power USB (Workable in system off mode)
- Touchpad Disable Button / Touch Pad Button



## User keys

- 1x button for Program DJ to Launch AP
- 2x buttons for WoW AV to change mode
  - Wow Video -- 5 modes
  - Wow Audio -- 5 modes

## AC Adapter

- Universal AC adapter. (90W with 19V DC/3 pin 240V AC cable)

## Battery

- 6-cell Li-On, 18650 type, 4800/5200mAh.
- Life Cycle: 70% Design Capacity after 300 Cycles in 25degreeC

## Software

- Insyde BIOS
- Suspend to DRAM/HDD
- Security: Power-On Password, Supervisor Password
  - HDD password
  - USB memory Boot support
- Support SMBIOS 2.4, PCI2.2
- Support PXE
- Wake on LAN from S3
- Wake on LAN from S4 /S5 in AC mode

## OS

- Windows 7 Ultimate (64bit)
- Ready for Windows 7 Premium (64bit)/Windows 7 Ultimate (32bit)

## Mini Card

- Two mini-card (WLAN x1, TV-Tuner x1 ) (Option)

## Security

- BIOS Password / Fingerprint / Kensington lock
- Trusted Platform Module: TPM 1.2

## Regulatory

- EMI: FCC-B, CE,C-Tick, BSMI
- Safety: Compliant to UL/CSA, TUV, and CB
- Energy Star /WHQL LOGO

## Environment

- Temperature: Operating: 5 - 35°C / Storage: -20 - 65°C
- Humidity: 10 - 90% without condensation.
- Altitude: Operating sea level up to 10,000 ft
- Storage sea level up to 40,000 ft

**Chapter 1**  
**Introducing Your Notebook**

## 1.1 Front Side

The following picture shows the front side of your notebook.

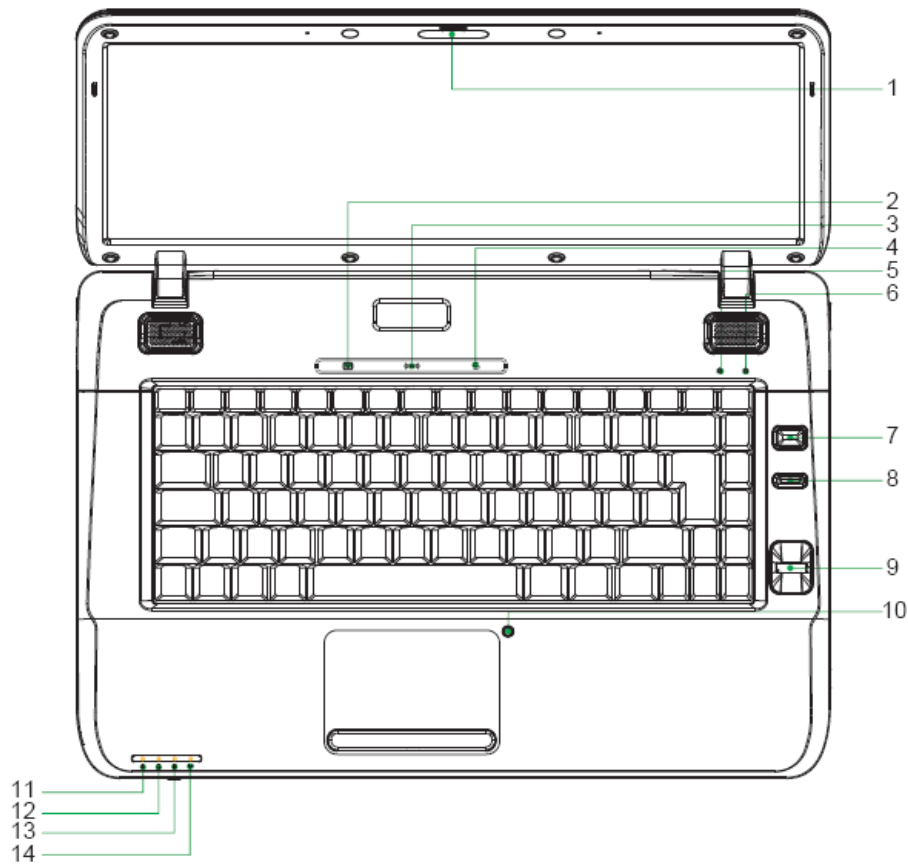

1	Camera	8	Power USB Button(Blue)
2	WoW Video(Blue)	9	Fingerprint
3	WoW Audio(Blue)	10	T/P Disable Button(Blue)
4	Smart Key(Blue)	11	Power(Blue)
5	Num Lock(Blue)	12	Battery(Blue/Amber)
6	Caps Lock(Blue)	13	HDD(Blue)
7	Power Button(Blue)	14	Bluetooth(Blue)/Wireless(Amber) LED

### 1.1.1 Camera

2.0M pixel CMOS via USB 2.0 interface

### 1.1.2 WOW Video Button

WOW Video is a setting assortment for Video conditions preset in color Defines.

### 1.1.3 WOW Audio Button

WOW Audio is a setting assortment for audio conditions preset in Tone, Bass, Balance and Volume.

### 1.1.4 Smart Key Button

Easy to launch Compal Innovative Products by Program DJ utility.

### 1.1.5 Num Lock (Blue)

Number Lock LED (Blue): Number Lock State of Keyboard.

### 1.1.6 Caps Lock (Blue)

Caps lock LED (Blue): Caps Lock State of Keyboard

NOTE: In normal mode (Cursor and Num function are disable), when users press Hot Key, the Cursor LED will be on. When users press Hot Key, the Cursor LED will be off.

### 1.1.7 Power Buttons



Press to turn your notebook on. For more on power settings,

See **6.1 Power Management**



Windows Vista, which comes preinstalled, goes into the shutdown sequence automatically if you press the power button while on.

In Windows Vista, you can configure this in Control Panel > System and Maintenance or Hardware and Sound > Power Options > Change plan settings > Change advanced power settings.

### 1.1.8 Power USB Button



The laptop is equipped with a power USB function, which allows you to increase the power output when charging an external USB device, such as a mobile phone or PDA.

You can charge external USB devices with power cable connected when the laptop is powered off, but this button must be pressed in order to do so.

### 1.1.9 Fingerprint

The fingerprint allows you to enroll the computer with registered fingerprint. This recognition device helps to prevent unauthorized access by others.

### 1.1.10 TP Disable (Blue)

To let you disable your touchpad to prevent input errors when typing on your laptop, you may press the Touch Pad disable button to toggle the touchpad on and off.

LED on while “touchpad enabled”

LED off while “touchpad disabled”

### 1.1.11 Power LED (Blue)

Power LED and Suspend LED indicate the systems power states by user combinations

### 1.1.12 Battery LED (Blue/Amber) ( )

Battery states LED is one dual-color LED indicator both of Blue and Amber color.

### 1.1.13 HDD accessing state Blue LED ( )

Reflect the activities of Blue LED.

Note: LED is controlled directly by hardware.

### 1.1.14 Bluetooth/Wireless Switch LED

1: kill switch On:

When users press Fn+F2, AP will be showed. At this time, User can turn on/off which Wireless LAN and Bluetooth.

2: kill switch Off:

In this status, show device OFF. When users press Fn+F2, AP will be show user that can not turn on the Wireless LAN and Bluetooth.

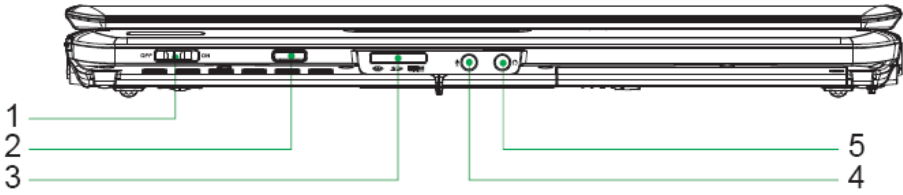

1	Wireless Kill switch
2	CIR
3	3-1 Card Reader
4	Microphone Jack(Pink)
5	Earphone Jack(Lime)

## 1.2 Right Side

The following picture shows the right side of your notebook.

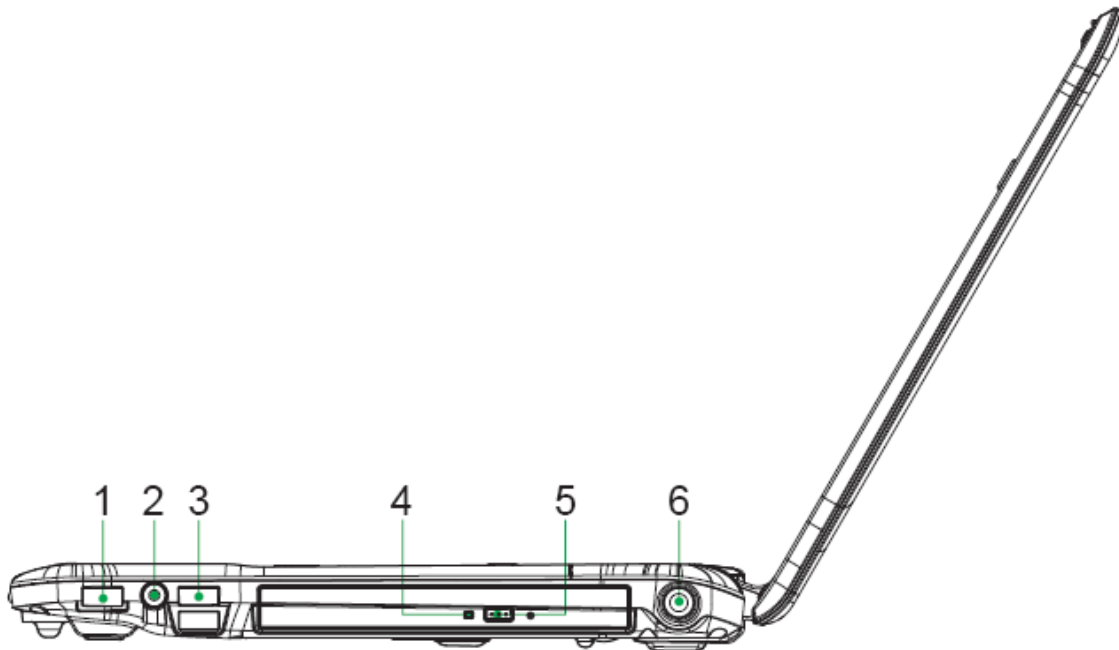

1	Power USB
2	RF in
3	Power USB x2
4	ODD LED
5	ODD Button
6	DC in

### 1.2.1 Power USB Port



When you press Power USB button under off mode, you can charge external USB devices with power cable connected.



USB is a peripheral expansion standard that supports data-transfer rates up to 480 Mbps. USB peripherals has a single standard for cables and connectors. You can install and remove USB devices while the computer is on. This is called “hot swapping”.

### 1.2.2 RF in

Use this port to connect an antenna set.

### 1.2.3 Optical Disc Drive

The optical disc drive provides a means for you to import/export data into/from your notebook. Depending on the configuration of your notebook, you may either be able to record or play CDs/DVDs /BDs.

### 1.2.4 AC Adapter Connector

- Use this connector to attach the AC adapter to your notebook. You can
- connect an AC adapter when your notebook is switched on or off.

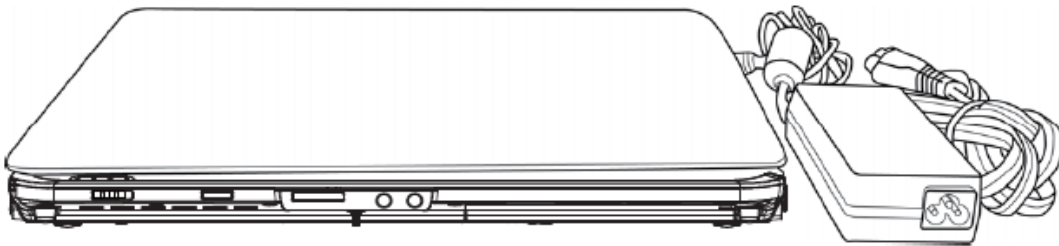

While the AC adapter works with electrical outlets worldwide, power connectors and power strips vary by country. Ensure you use a compatible cable or correctly connect the cable to the power strip or electrical outlet. Failure to do so may cause fire or damage to equipment.



## 1.3 Left Side

The following picture shows the left side of your notebook.

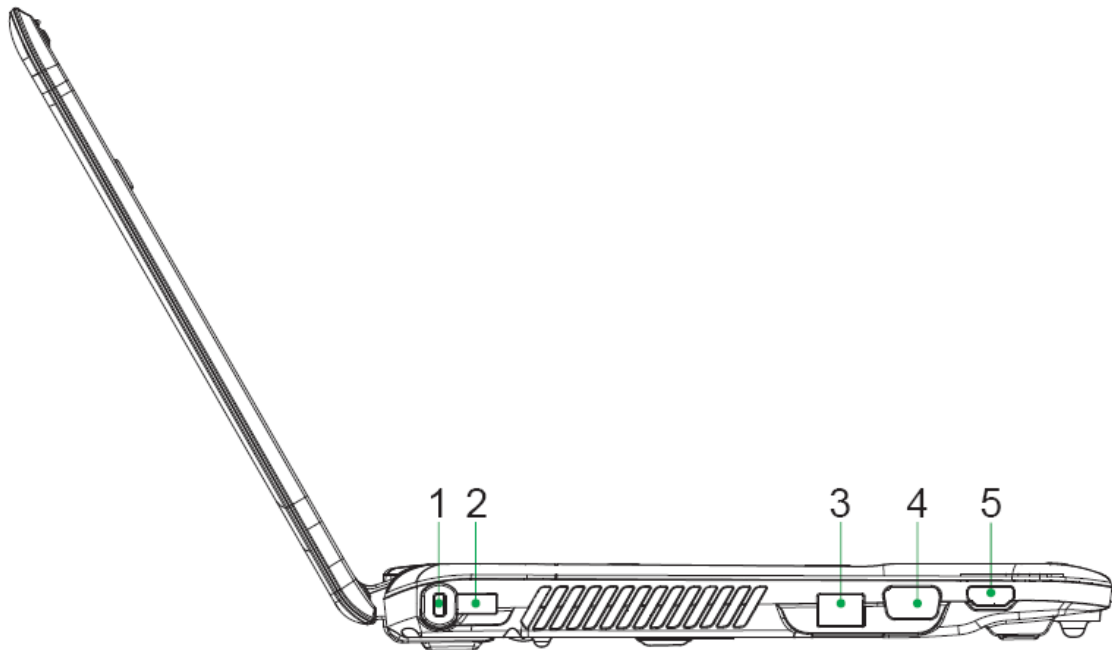



1	Kensington Lock
2	Power USB
3	RJ-45
4	D-SUB(Blue)
5	HDMI

### 1.3.1 Kensington Lock

A Kensington Security Slot is a small, metal-reinforced hole found on almost all small or portable computer and electronics equipment, particularly on expensive and/or relatively light ones, such as laptops, computer monitors, desktop computers, gaming consoles, and video projectors. It is used for attaching a lock-and-cable apparatus, in particular those from Kensington.

### 1.3.2 Power USB Port

 When you press Power USB button under off mode, you can charge external USB devices with power cable connected.

 USB is a peripheral expansion standard that supports data-transfer rates up to 480 Mbps. USB peripherals have a single standard for cables and connectors. You can install and remove USB devices while the computer is on. This is called “hot swapping”.

### 1.3.3 LAN Jack

 The RJ-45 network jack allows you to connect your notebook to a local area network (LAN).

 Be careful not to plug the telephone line into the slightly larger network connector.

### 1.3.4 HDMI Port

The High-Definition Multimedia Interface (HDMI) is a compact audio/video connector interface for transmitting uncompressed digital streams. It represents a digital alternative to consumer analog standards such as Radio Frequency (RF) coaxial cable, composite video, S-Video, SCART, component video, D-Terminal, and VGA.

## 1.4 Bottom Side

The following picture shows the bottom side of your notebook

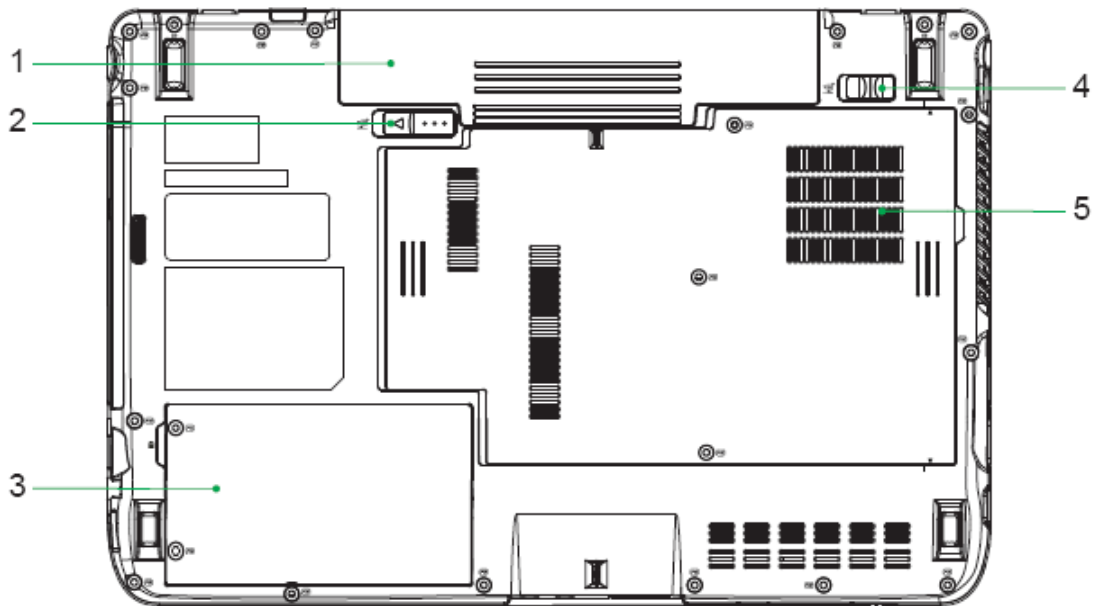

1	Battery Pack
2	Battery Release Latch
3	HDD Cover
4	Battery Lock Switch
5	Thermal Cover

### 1.4.1 Battery Pack

With a charged battery pack installed, you can use your notebook without connecting it to an electrical outlet. For more details, see *6.2 Battery*

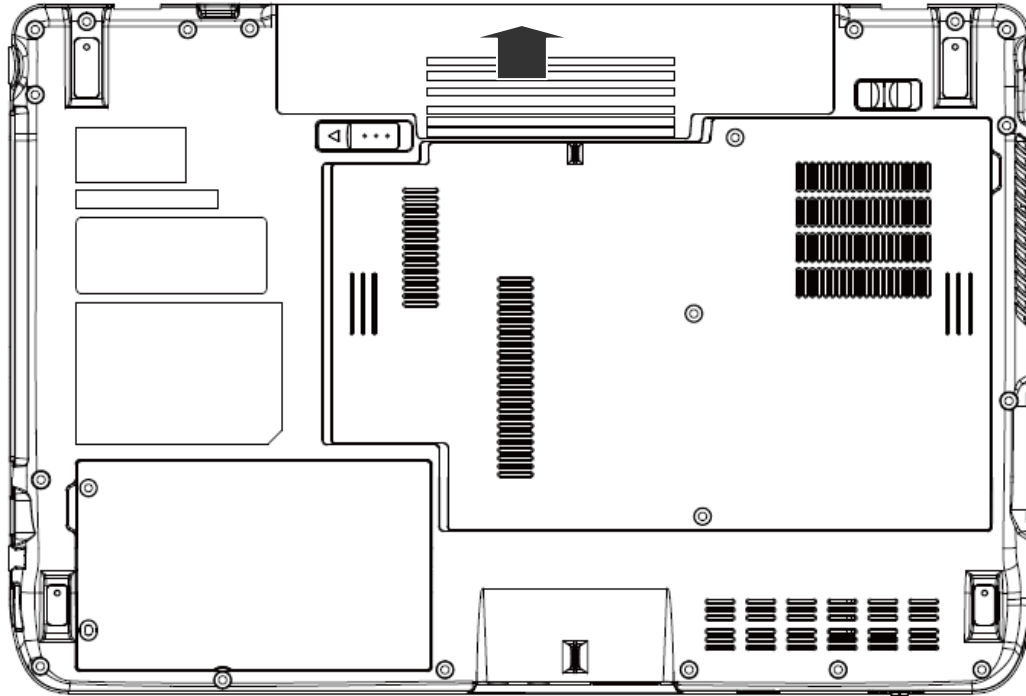

To remove the Battery Pack:

Move the Battery Lock Switch to the right (Unlock position).

Slide the Battery Release Latch to the left and gently pry the Battery Pack from the computer chassis.

### 1.4.2 Battery Release Latch

The Battery Release Latch secures the battery pack. To release, slide the latch and then remove the battery pack from the bay.

**Chapter 2**  
**Operating Your Notebook (Windows 7)**

## 2.1 Turning Your Notebook On and Off

- Turning Your Notebook On
- Turning Your Notebook Off
- Logging Off
- Adding User Accounts
- Sleep Mode

### 2.1.1 Turning Your Notebook On



You can configure the computer to start from a specific drive, such as an external floppy disk, or even an external device. See **7.5 The Boot Menu**.

Press the power button  to turn on your notebook.



Do not turn off the computer until the operating system has loaded completely. Turning the computer off during its initial startup will result in an error the next time you start your notebook.

### 2.1.2 Turning Your Notebook Off

Save and close any open files, exit any open programs.

Click **Start > ► > Shut Down**.

Your notebook will automatically turn off after the shutdown process is finished.



Press the power button to shut down or enter sleep mode. Click **Start > Control Panel > Power Options > Choose what the power button does**.

### 2.1.3 Logging Off

With Microsoft Windows 7, multiple users have access to a single computer with their own personal settings. Using their own password, each user can log on to the computer which uses their own private profile and settings.

To log off:

Save and close any open files, exit any open programs, click **Start > ► > Log Off**.

To switch users:

Click **Start > ► > Switch User**.

Using **Fast User Switching**, programs executed by previous users remain running in the background. This means a possible slower computer response. It may also stop multimedia programs, including games and DVD software, from running.



Fast User Switching does not work if your notebook is running Windows 7 and is a member of a computer domain or if your notebook has less than 128 MB of memory.

### 2.1.4 Adding User Accounts



Different account options are available when a computer is running Windows 7 operating system and is connected to a domain.

With Windows 7 installed, the system administrator or a user with administrator rights can create additional user accounts:

Click Start > Control Panel > User Accounts and Family Safety > User Accounts > Manage another account.

When prompted, click **Continue**.

Click Create a new account.

Enter the name of the new user and choose one of the following options:

- **Standard user:** User can install some programs and hardware.
- **Administrator:** User can change all computer settings.

Click Create Account.

### 2.1.5 Sleep Mode

To find out how to conserve power using the Sleep Mode, see **6.1 Power Management**



## 2.2 Tips for Using Windows

- Microsoft Windows 7 Help
- Windows Desktop
- Start Button
- Taskbar
- Notification Area (System Tray)
- Recycle Bin
- Control Panel
- Computer

### 2.2.1 Microsoft Windows 7 Help

For Microsoft Windows 7 help, go to **Start > Help and Support**. The Windows Help and Support dialog box opens.

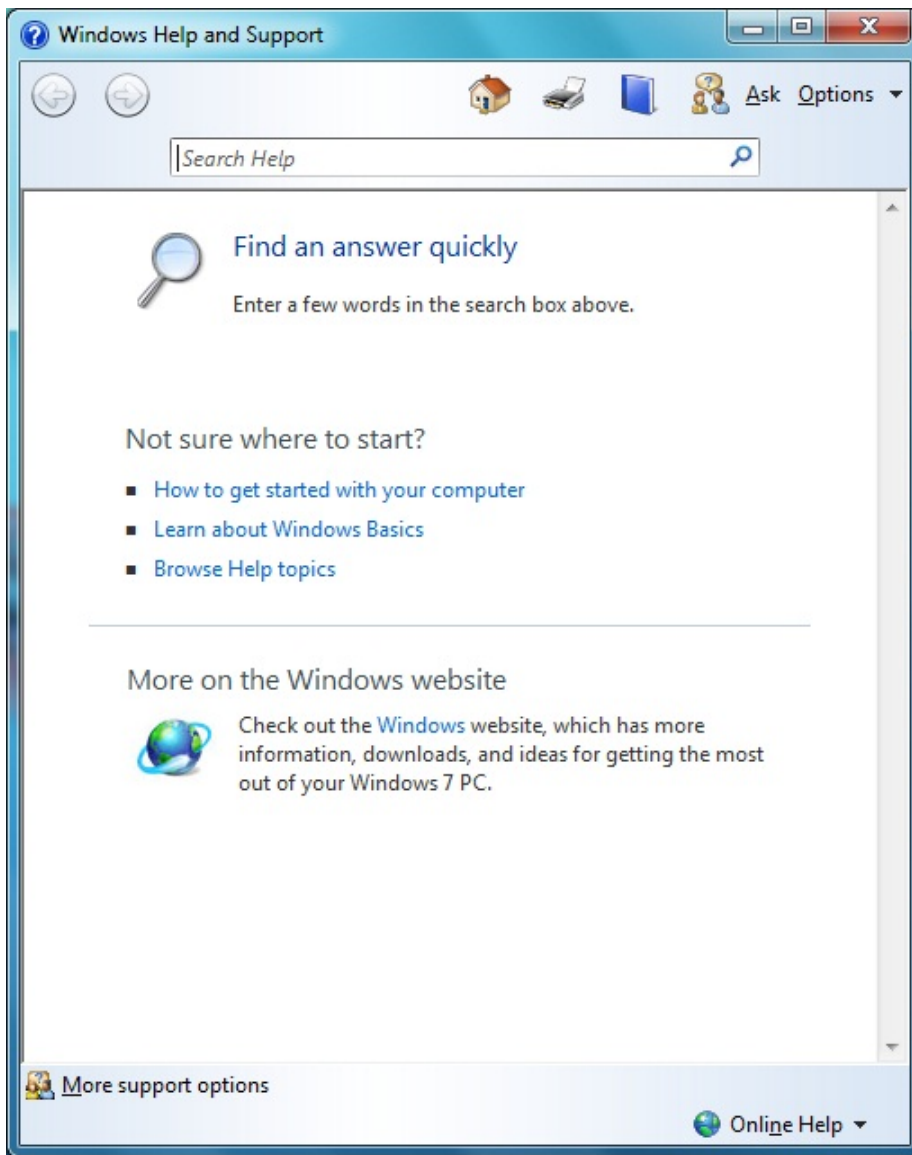

### 2.2.2 Windows Desktop



Depending on your notebook setup and software, your desktop may have different or additional shortcuts. See **2.4 Personalizing Your Desktop** for more information.

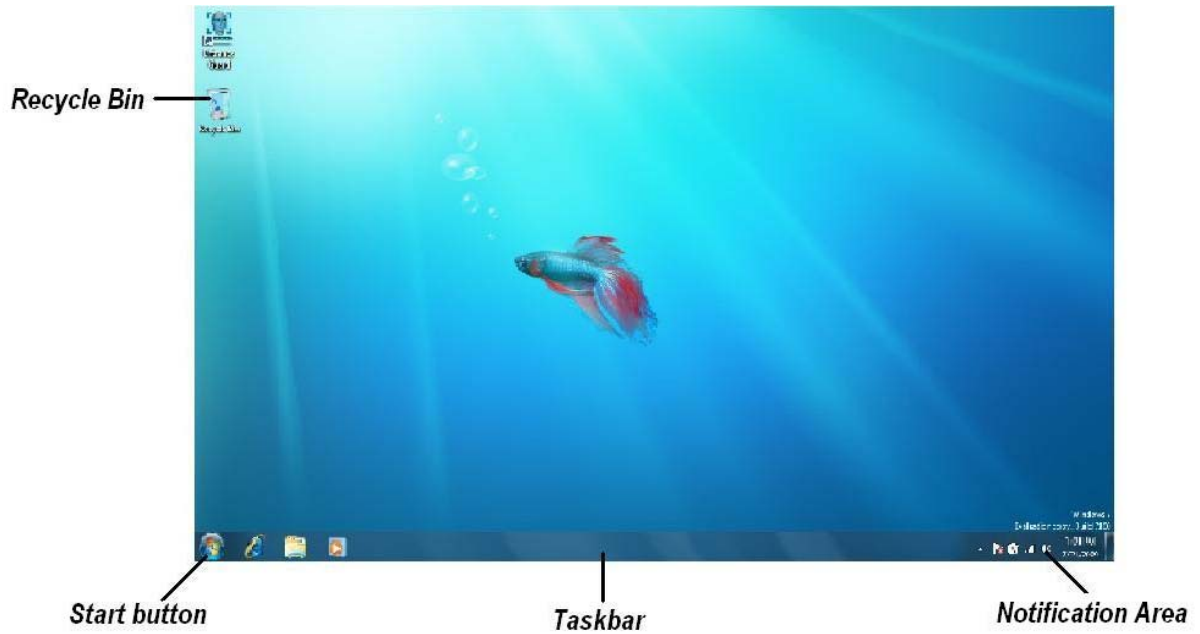

### 2.2.3 Start Button

The **Start** button allows easy access to your notebook's programs.

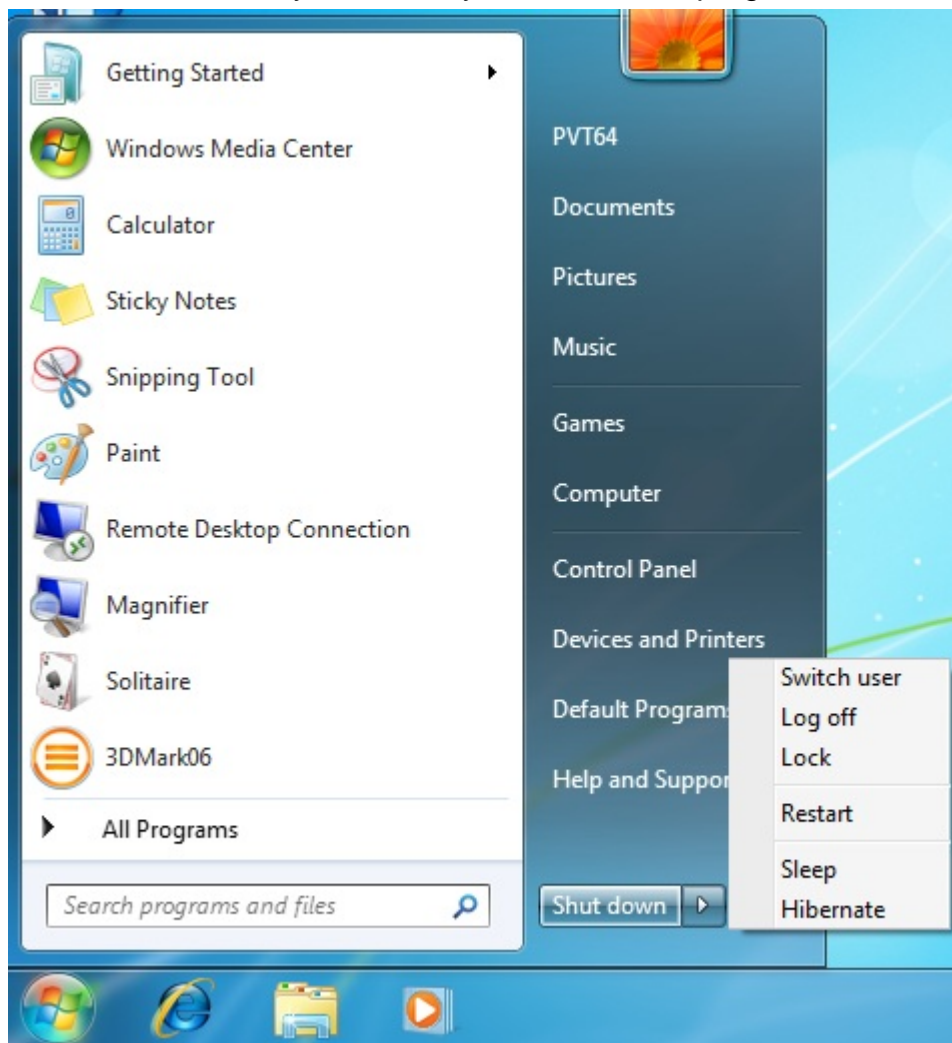

The **Start** menu is designed to adapt to show the programs you use most frequently. To always keep an item on the **Start** menu, no matter how often it's used, right-click the item and click **Pin to Start menu**.

1. Puts the current session into memory and enters a low-power state ready to be resumed.
2. Locks this computer  
provides options for turning off, restarting, switching users, logging off, and placing your notebook in power saving modes.

### 2.2.4 Taskbar

The **Start** button is on the left and the notification area on the right. Each time you open a program; a button for it appears on the taskbar. To move between programs, simply click the relevant button. Windows 7 groups multiple instances of the same program on a single taskbar button if more space is needed.

Toolbars can be added to or removed from the taskbar:

Right-click an empty spot on the taskbar, and select **Toolbars > choose the toolbar you want to add**.

## 2.2.5 Notification Area (System Tray)

The icons in this area allow quick access to programs and computer functions, including the clock and printer status. Windows 7 hides icons that are not frequently used. Click < to see hidden icons.

To prevent Windows 7 from hiding icons:

Right-click an empty spot on the **Taskbar > Properties > Notification Area >** ensure that **Hide inactive icons** is not checked.

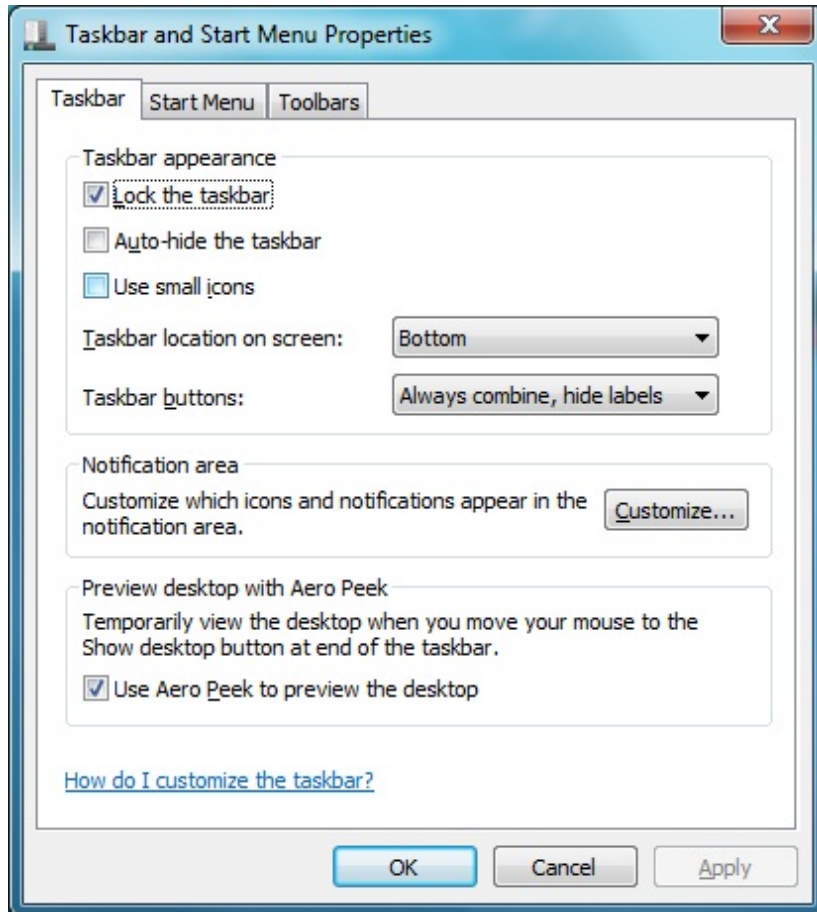

## 2.2.6 Recycle Bin

When you delete a file, it is moved to the **Recycle Bin**. Files can be restored from the **Recycle Bin**.

Emptying the **Recycle Bin** deletes files permanently.

## 2.2.7 Control Panel

In the **Control Panel**, you can change how Windows looks and works.

Click the **Start** button and then **Control Panel**.

There are two interfaces - you can choose either **Control Panel Home** or **Classic View**. You can switch interfaces in the upper left hand of the **Control Panel** window.

Choose the task description you wish to complete, and then choose the task in the next window.

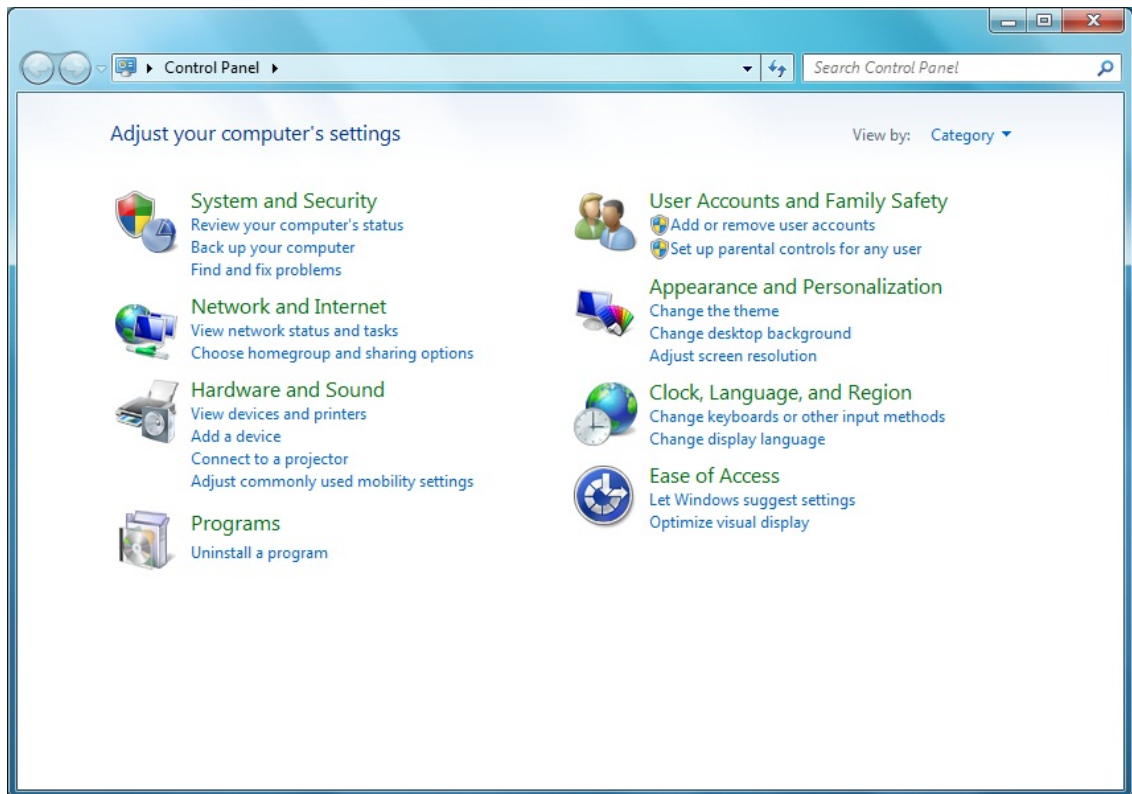

### 2.2.8 Computer

**Computer** allows you to see the disk drives and other external devices connected to your notebook. The **Computer** icon displays on your Desktop. To see the contents of a drive or folder, open **Computer** then double-click the icon of the drive or folder you want to view (for example, drive C).



You can also use **Windows Explorer** to see the contents of your notebook and find files. To open **Windows Explorer**, right-click the **Start** button and click **Explore**. Find the drive or folder that you want to view. To find out more about **Computer** and **Windows Explorer**, see the **Windows Help and Support**.

## 2.3 Keyboard and Touch Pad

- Numeric Keypad
- Keyboard Shortcuts
- Windows Logo Key Functions
- Sticky Keys
- Touch Pad Area
- Customizing the Touch Pad

### 2.3.1 Numeric Keypad

Keypad numbers and symbols are marked in blue on the lower right edge of the keypad keys.

To enable the numeric keypad, press .

The  indicator will light when the numeric lock is on.

To disable the numeric keypad, press  again.





To use the primary function of a dual-function key when the numeric keypad is enabled,

Press  and the desired key.













### 2.3.2 Keyboard Shortcuts

 	Sleep
 	Wireless/Bluetooth on/off
 	LCD/CRT switch
 	Brightness Down
 	Brightness Up
 	Speaker ON/OFF
 	Volume Down
 	Volume Up
 	Media Play/pause
 	Media Stop



 	Media Previous Track
 	Media Next Track

### 2.3.3 Windows Logo Key Functions

 	Opens Windows Explorer
 	Opens the Run dialog box
 	Opens the Search Results dialog box
  	Opens the Search Results - Computers dialog box (when your notebook is connected to a network)
 	Opens the System Properties dialog box
 	Open Windows Mobility Center

To adjust keyboard operation, including character repeat rate, in the **Control Panel** click **Hardware and Sound > Keyboard**.

### 2.3.4 Sticky Keys

The Sticky Keys function lets you use the SHIFT, CTRL, ALT, FN keys or the Windows logo key (referred to as modifier keys) in conjunction with other keys by pressing one key at a time instead of simultaneously.

To activate Sticky Keys mode, press the Shift key five times and then click **YES**.

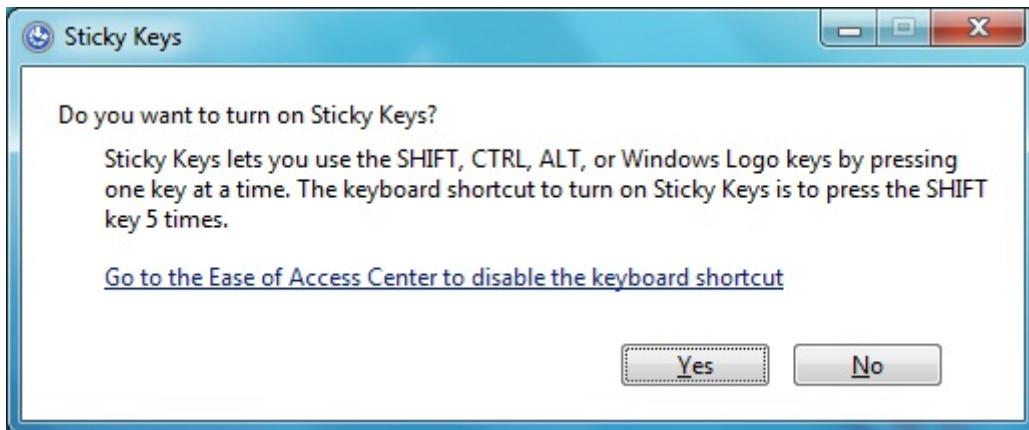

Alternatively, you can click on Start > Control Panel > Ease of Access > Change how your keyboard works and check Turn on Sticky Keys before clicking Save.

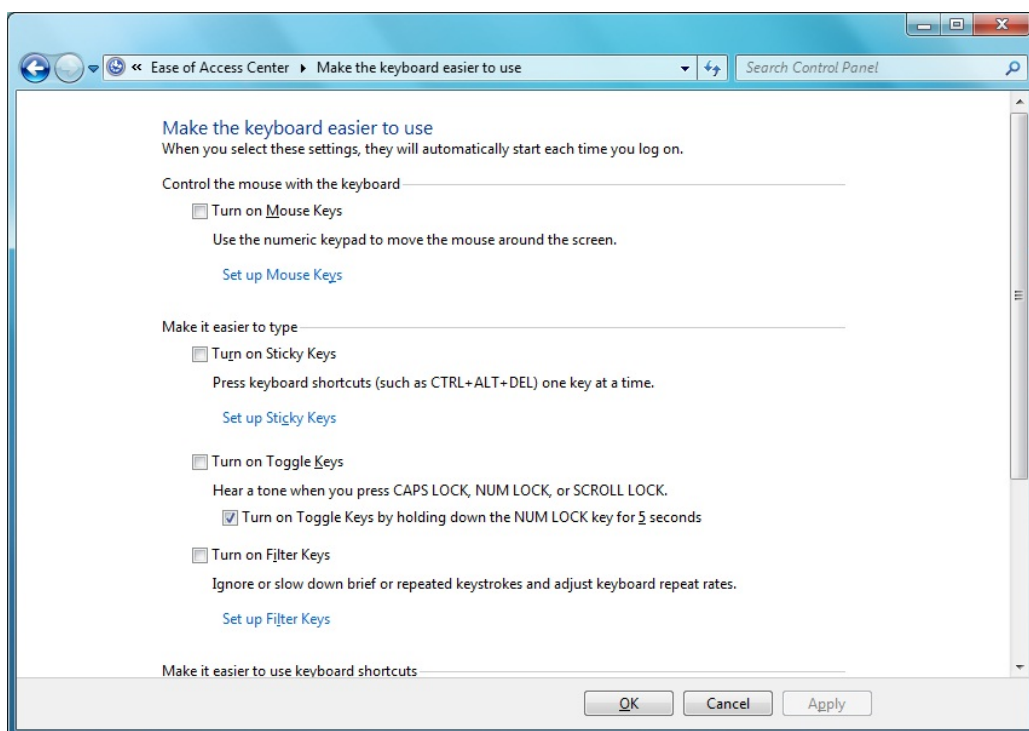

To further customize **Sticky Keys**, click **Set up Sticky Keys** in the above dialogue box. The following dialogue box will appear.

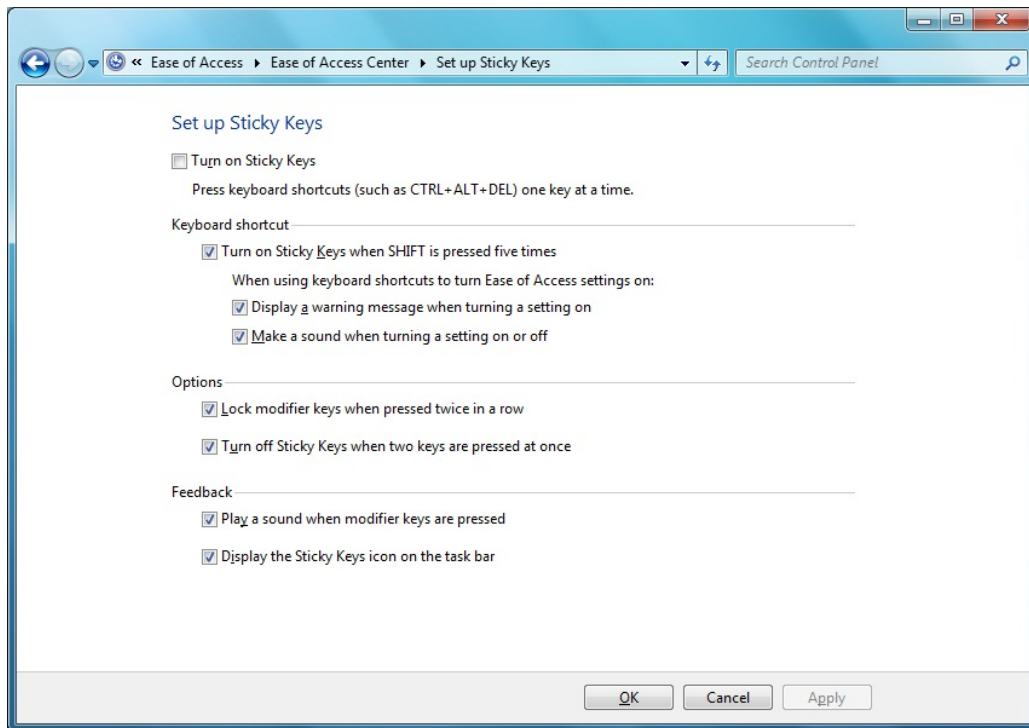

Click **Turn on Sticky Keys** to enable the listed shortcuts to activate Sticky Keys mode.

By checking **Lock modifier keys when pressed twice in a row**, pressing the **SHIFT, CTRL, ALT, FN** or the Windows logo key twice will 'lock' the key until it is pressed again. This allows you to perform multiple commands with these keys in succession without having to press the modifier key again each time.

Check **Turn off Sticky Keys when two keys are pressed at once** to have Sticky Keys automatically disable whenever any two keys are pressed simultaneously.

If **Play a sound when keys are pressed** is checked, a tone will be heard each time a modifier key is pressed. Different tones are heard when activating and deactivating modifier keys.

Check **Display the Sticky Keys icon on the task bar** to display the Sticky Keys icon in your toolbar whenever the Sticky Keys mode is activated. The icon will change to indicate which modifier key, if any, is currently active.

Click on **Save** to confirm your changes, **Cancel** to exit the dialogue box without making any changes, or **Apply** to have your settings take effect without saving.

### 2.3.5 Touch Pad Area

The Touch Pad Area responds to the movements and pressure of your finger, allowing you to move the cursor around the screen, in the same way you would with a mouse. (The Touch Pad Area as the red marked in the figure.)

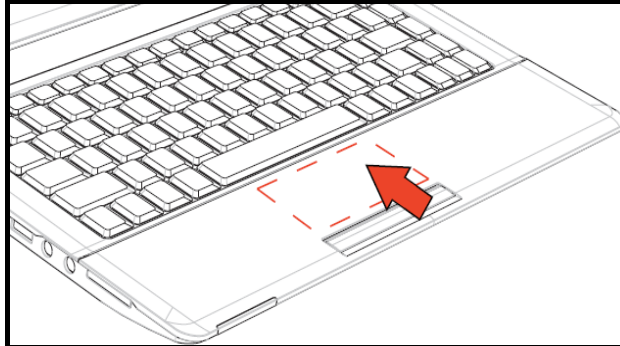

Place your fingers on the keyboard in the normal typing position.

You can use the Touch Pad by moving either your right or left thumb off the space bar and on to the Touch Pad Area.

Gently move your index finger across the Touch Pad Area in the direction you want the cursor to move. The Touch Pad buttons have the same function as mouse buttons. Clicking these buttons to make selections, drags objects, or performs a variety of other functions depending on the software. To select an object, first move the pointer over the object you want to select, and then press the left button one time and release it. The functionality of these buttons depends on your software.

Double-clicking is a common technique for selecting objects or launching programs. You may also select object or execute applications from the icons by double tapping. This is similar to double-clicking; instead of pressing the Touch Pad buttons, you tap the Touch Pad itself.

### 2.3.6 Customizing the Touch Pad

To adjust Touch Pad settings, use the Mouse Properties window, which you can open by clicking **Control Panel > Hardware and sound > Mouse**.

Select the desired settings and click **Apply**.

Click **OK** to save the settings and close the window.

## 2.4 Personalizing Your Desktop

- Choosing a Wallpaper
- Choosing a Screen Saver
- Choosing a Desktop Theme
- Creating a Shortcut on the Desktop

### 2.4.1 Choosing a Wallpaper

To make your notebook reflect your style, you can set background colors, patterns, and the wallpaper on the desktop.

**Control Panel > Appearance and Personalization > Change desktop background.**

Choose the picture or color you want for your desktop background.

You can also choose your own images by choosing **Browse**, and specifying images in a directory.

Under **How should the picture be positioned**, choose a way for the position of your selected image: **Fit to screen** (scales the image to fit the screen), **Tile**, or **Center** (places one copy of the image in the center of the screen).

To accept the settings, click **OK** to save your settings and close this window.

### 2.4.2 Choosing a Screen Saver

**Control Panel > Appearance and Personalization > Change screen saver.**

Select a screen saver from the Screen saver pull-down menu, or click **(None)** if you prefer not to activate a screen saver.

You can customize your screen saver by choosing **Settings**. To check your selections, choose **Preview**.

To accept the settings, click **OK** and close the **Screen Saver Settings** window.

### 2.4.3 Choosing a Desktop Theme

Desktop themes change the appearance of your desktop and add sound effects:

**Control Panel > Appearance and Personalization > Change the theme.**

Select a theme from the Theme pull-down menu in the **Theme Settings** Window, and then click **OK**.

### 2.4.4 Creating a Shortcut on the Desktop

A shortcut is an icon that is placed on the desktop let you quickly access programs, files, folders, and drivers. To create a shortcut:

Open **Computer** or **Windows Explorer**, and highlight the file or program you want to create a shortcut to.

Click and hold down the right Touch Pad button, drag the highlighted item to the Windows desktop, and then release the right Touch Pad button to display a pop-up menu.

Click **Create Shortcuts Here**.



An icon appears on your desktop - double-click to activate the shortcut.

## 2.5 Display

- Adjusting the Brightness
- Using an External Monitor or Television
- Setting the Display Resolution

### 2.5.1 Adjusting the Brightness

To conserve power when running your notebook from the battery, set the brightness to the lowest comfortable setting using the keyboard shortcuts.

	Brightness Down
	Brightness Up

### 2.5.2 Using an External Monitor

When you start your notebook with an external display device such as an external monitor attached and turned on, the image may appear on either the display or the external device.

Alternatively, you can press  to switch the video image to the display only, the display and the external device simultaneously, or the external device only.

### 2.5.3 Setting the Display Resolution

To view a program at a specific resolution, both the video controller and display must support the program and the necessary video drivers must be installed.

Before changing any of the original display settings, note the original settings for future reference.

Click **Start > Control Panel > Appearance and Personalization > Adjust screen resolution**.

You can try different settings for screen resolution and color quality.

If you choose a resolution or color depth that is higher than the display supports, the settings will automatically adjust to the closest possible setting.



## 2.6 Networks

To access a network:

At the office, you can access a network via the built-in PCI-E LAN.

For specific information about connecting to the LAN or WAN, consult your systems administrator.

If you are working at home or while traveling, you need a dial-up connection. Ask your system administrator for the telephone number of the network.

To set up the connection, go to **Start > Control Panel > Network and Sharing Center**. Click **Set up a connection or network** on the left pane of the Network and Sharing Center window.

Choose a connection option and follow the on-screen instructions to set up your network connection.

## 2.7 Managing Programs

- Running Programs
- Adding Software
- Removing Software

### 2.7.1 Running Programs

Programs are any software that process data - like a word processing program or an email program. They require an operating system - like Windows 7 - to run on.



To run a program, click **Start > All Programs**.

Click the program you want to run.

On the right side of the title bar in the window of any open program there are three icons:



 Minimize the program window. That is, it is removed from the screen, but is still running. It will appear as a button on your bottom taskbar. To restore the program window, simply click the button.

 Maximize the window to fill your entire screen. When the window is maximized, the button switches to , which will reduce the size of the window when clicked.

 Close the program or document.

### 2.7.2 Adding Software

To check what software is already installed on your notebook, click **Start > All Programs**. If a program is listed in the **All Programs** menu or the **Start** menu, the software is already installed.

Before installing software, check the software's technical requirements to ensure that it is compatible with your notebook and that there is enough memory and hard drive space for installation and operation.

Temporarily disable your notebook's antivirus software before installing software. See the documentation that came with the antivirus software for detailed procedure.



Be sure to enable your antivirus software once you have installed any new software.

Insert the software installation CD into the CD drive and follow the instructions that came with the software to help you respond to the prompts on the screen.

If the software installation CD does not automatically run, click **Start > All Programs > Accessories > Run**. In the dialogue box, type x:\setup.exe (where x is the letter of your CD drive [usually D or E]). Then click **OK** and follow the prompts on your screen.

### 2.7.3 Removing Software



Once you've begun removing software, do not interrupt the process. To do so may result in data loss and corruption of your operating system.

**Start > Control Panel > Programs > Uninstall a program.**

Select the program that you want to remove and click the **Uninstall** or **Change** button. Instructions for removing programs will appear on the screen.



Some programs may not be listed and cannot be removed via this window. In this case, check the documentation that came with the specific program.

## 2.8 Managing Files

- Updating Antivirus Software
- Backing Up Files
- Finding Files
- Copying a File on the Hard Drive
- Renaming Files
- Deleting Files
- Emptying the Recycle Bin
- Retrieving Files From the Recycle Bin

### 2.8.1 Updating Antivirus Software

There are thousands of known viruses, and more appear all the time. Installing antivirus software is the only way to protect your data, software and hardware. Regular updates are necessary to ensure protection.

Your notebook dealer can advise you regarding purchasing antivirus software.



Before installing any software from unlicensed sources, scan for viruses. Regularly backup your data to safeguard against loss if your notebook is infected.

### 2.8.2 Backing Up Files

Regularly backing up your files will protect you from losing data from accidental file deletion, viruses or hard drive failure.

Programs can be reinstalled, unless you have backed up your work, you will lose your data files.

The most convenient way to back up your files is to a CD-RW drive. For smaller files, you can use a floppy disk.

### 2.8.3 Finding Files

Right click on **Start > Search**.

In the search window, type a word or part of a word in the search box.

As you type, files from a variety location (drives and folders on your notebook) that match your text will appear.

You can click one of the available filter buttons to show only certain kinds of files, such as E-mail, Document, Picture, or Music.

### 2.8.4 Copying a File on the Hard Drive

From the Desktop, select Computer.

Locate the file you want to copy, and click the file to select it.

Right click the file you want to copy, and then click Copy.

Open the location where you want to store the copy.

Right click within the location, and click Paste.

### 2.8.5 Renaming Files

Use **Windows Explorer** or **Computer** to locate the file you want to rename, and click the file to select it.

Click the **Organize** menu and select **Rename**.



Never change a file's extension (the last three characters after the period). Doing so may render the file unusable.

Type the new filename and press **Enter**.

### 2.8.6 Deleting Files



Never delete files that are part of an installed program. Doing so may render the file unusable.

Use **Windows Explorer** or **Computer** to locate the file you want to delete, and click the file to select it.

Click the **Organize** menu and click **Delete**.

Click **Yes** to send the file to the **Recycle Bin**.

If you accidentally delete a file, see **2.8.8 Retrieving Files From the Recycle**

### 2.8.7 Emptying the Recycle Bin

Files remain in the **Recycle Bin** and take up space on the hard drive until you empty them from the **Recycle Bin**.



Files deleted from an external drive or from a network are permanently erased. You cannot recover them from the Recycle Bin.

Double-click the **Recycle Bin** icon.

The **Recycle Bin** window appears and lists all deleted files, their previous locations, and the dates you deleted them.

Click the **File** menu, and click **Empty Recycle Bin**.

When the confirmation dialog box appears, click **Yes** to delete all file(s).

All files disappear from the **Recycle Bin** and are removed from your notebook.

### 2.8.8 Retrieving Files From the Recycle Bin

Deleted files are moved to the **Recycle Bin** and remain there until you empty the Recycle Bin. If you delete a file in error, you can retrieve it from the **Recycle Bin**:



Double-click the **Recycle Bin** **Recycle Bin** icon.

The **Recycle Bin** window will appear, listing all deleted files, their previous locations, and the dates you deleted them.

Select the file you want to retrieve, and click **Restore this item**.

The file disappears from the **Recycle Bin** and is moved to its original location.

You can also recover all the files from the **Recycle Bin** by clicking **Restore all items**.

## 2.9 Playing Movies

- Adjusting the Volume
- Adjusting the Picture



### 2.9.1 Adjusting the Volume



If you do not hear anything when playing a CD or DVD, check that the speakers are not muted.

**Start > All Programs > Accessories > Windows Mobility Center.**

In the **Windows Mobility Center** window, click and drag the bar in the **Volume** column and slide it left or right to decrease or increase the volume.

	Volume Down
	Volume Up

### 2.9.2 Adjusting the Picture

If you receive an error message that the current resolution and color depth are using too much memory and preventing DVD playback, adjust the display properties:

**Start > Control Panel > Appearance and personalization > Personalization > Display Settings.**

In the **Display Properties** window, click and drag the bar in **Resolution** section to change the setting to 1024 x 768 pixels.

Click the pull-down menu under **Colors**, select **Medium (16 bit)**, and click **OK**.



**Chapter 3**  
**Innovative Product Feature**

### **About this Feature Guide**

This feature guide is designed to highlight and clearly illustrate the 2009 innovative features and let you easily understand, hands-on, the most important is, to utilize this innovative features at the best efficiency.

### **What you can find in this guide:**

- Introduces the 2009 innovative features come with your notebook.
- Illustrates the feature details in operation procedure and applicable scenario.
- Highlight the characteristic of the new innovative features.

Information in this document is subject to change without notice

© Compal Electronics, Inc. 2009. All rights reserved.

Trademarks used in this document: Microsoft and Windows are registered trademarks of Microsoft Corporation. +

Other trademarks and trade names may be used in this document to refer to either the entities claiming the marks and names or their products.

Features described in this product guide are developed and copyright owned by Compal Electronics, Inc. Some of the features may not be available in certain models.

The combination of the features is model dependent.

### **What Features we are offering to you**

1. Program DJ contains a set of innovative value-added software that brings you the consideration and convenience features.
2. Video and Audio preference setting for joyful experience.
3. Advanced biotechnology on facial recognition and identification system for in depth security control.
4. Power management on system camera monitoring, battery charging methodology and extra power source ports.
5. Camera monitoring usage for protecting content security from been stolen.
6. EzRemote and EzTube can supply simply management for access point or files and so on

## Easy Logon

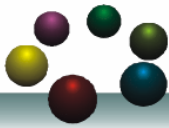

### Program DJ

- *Easy to launch* Compal Innovative Products
- *Friendly operations to fast select* various applications
- Enables *better control, design, and development* from richer user interface
- Experience the *different impressions* on using and controlling applications

## Power Control



### Green Charger

- By adjusting the methodology of the battery capacity recharging, Green Charger can *extend total battery efficiency and life cycle*
- Users choose the most appropriate mode according to their using behavior.

## Joyful Experience



### WOW Audio

- WOW Audio is a setting assortment for audio conditions preset in Tone, Bass, Balance and Volume that offer users a chance to select the most-fit combination according to their preference.
- The preset scenarios are Normal, Speech, Classic, Rock and POP



### WOW Video

- Setting assortment for video conditions preset in Color Defines, Resolutions and Viewing to select that offer users a chance to select the most-fit scenario according to their preference.
- The preset scenarios are Normal, Office, Photo, Movie and User Define.
- The User Define option provides user an advanced chance to customize their personal scenario.

## Depth Security Control



### Entrance Guard

- When power-on, the system automatically enable the build-in webcam and execute a security check from its database to see if the user had been authorized to allow to get into the system or not.
- It is not very safe for neither ID nor password is showed on the screen.



### Smart Watchdog

- Watchdog can detect the presence of the users for an advanced power management and enhance the security of the data inside the System from spying.



### Safety Guard

- Safety Guard utilizes camera and microphone to guard your properties. If any behavior had been detected, Safety Guard starts to *record* and *stores the frames* in the storage.
- Provides the remote notification function by *sending out* users email and SMS

## User Friendly



### Wireless Switch

- Providing a GUI interface for fast wireless switching on excising wireless devices.
- When Bluetooth and WLAN (802.11X) devices both exist, users can switch both or either device on or off according to their preference.

## Project communication



### EzRemote

- Configure Free function provide user to select switch condition and Wireless LAN Type.
- System will scan and connect Access Point manually or automatically
- Follow OS behavior to scan the Access Point automatically once a while, and connect to other Access Point when the network has just broken.
- Auto Switch APs. When current signal of Access Point is less than 50%, system will base on the setting to switch to other Access Point.
- EzRemote has a build-in instant message service which can communicate among ends in the same access point without identification. It can support at most 4 peers in the same chatting



### EzTube

- Recording and play.
- Allows user can upload video or image to YouTube or Flickr popular website. Files manage.

## How to Launch Innovative product

### ■ From Start Menu

Innovative Product can be launched from start menu

**Start--> Program DJ--> Innovative Product**

### ■ From Program DJ

By clicking on the Innovative Product icon can be launch the Program DJ

## Scenarios

Launch Compal application via Program DJ

## 3.1 Easy Logon

### 3.1.1 Program DJ



*Figure 01: Program DJ Main Dialog*

#### **Operation Procedure**

To launch Program DJ, the Program DJ mains interface appears for users to select the program they want to use.

The sequence of icons depends on what and how much application has been installed.

 The application quantities may not be the same because some applications need special hardware.

#### **User Interfaces**



1. Close button 

To close Program DJ, click on the close button on the side or press the preset Program DJ launch key to close it. Program DJ will not withdraw back after application software has been selected. It will remains for further application selection.

2. Setting button 

There are four directions-Top/Bottom/Left/Right.

User can click the setting button, it can chose direction of Program DJ dialog.(See Figure 02). When setting dialog has been called up for selection, no any other button in Program DJ can be activated nor executed. Press "OK" button to close the Setting dialog for further Program DJ function access.

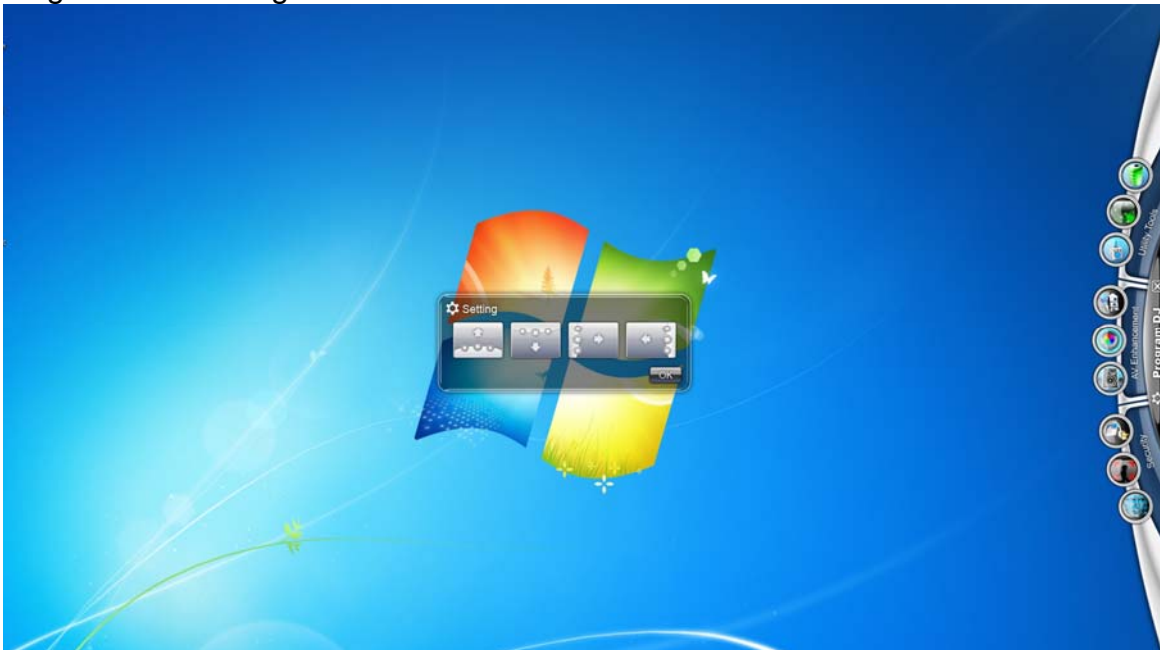

*Figure 2: Setting Dialog*

### 3.2 Power Control

#### 3.2.1 Green Charger

##### Scenarios

An environmental care concept had been applied to the product by utilizing the mechanism of battery management to keep the earth green as well as extend the life cycle of the battery usage.

##### Main Functions

There are 3 modes to choose from when recharging the battery. Users choose the most appropriate mode according to their using behavior.

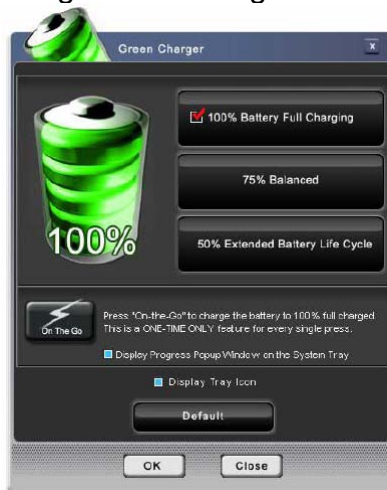





Figure 03: Green Charger Configuration Dialog

- (1)  **Battery Full Charged**  
Green Charger will charge the battery to a fully charged status of its capacity. The benefit for this mode is to maintain the battery in its biggest capacity status against to its nature decadency.
- (2)  **Balanced**  
Green Charger will charge the battery to a 75% charged status of its capacity. The benefit for this mode is to meet the advantage between battery Capacity and Life Cycle.
- (3)  **Extended Battery Life Cycle**  
Green Charger will charge the battery to a 50% charged status of its capacity. The benefit for this mode is to extend the battery life cycle from its material characteristics.



If you need to use the notebook in the DC mode, you should need a full-charged battery to extend DC mode usage duration.

(4)  **“On-the-Go” Button**

After the user click the **“On-the-Go”** button to launch this feature, the system will charge the battery up to 100% capacity while in the “75% Balanced” & “50% Extended Battery Life Cycle” modes. After the battery is charged completely, it will not charge any more and the charging ratio settings will restore to the current user preference.

Note that if you still plug the AC cable, the battery will discharge to current charging ratio. (Ex. 75% or 50%). This is a feature of only one time for every single press. Then, users can go for a meeting or others with full-charged battery and without power cord.



1. User can click the “Default” button to load the default Green Charger settings. After clicking the “Default” button, it will restore all options to default settings. It will activate the settings only after clicking the “OK” button, or else, discard them by clicking other buttons.
2. User can click the “OK” button to save the current Green Charger settings and make the changes take effect.
3. User can click the “Close” or “X” button to discard all the changes. All of the original settings will not be changed.

## 3.3 Joyful Experience

### 3.3.1 WOW Audio

#### Scenario

WOW Audio is a setting assortment for Video conditions preset in Tone, Bass, Balance and Volume that offer users a chance to select the most-fit combination according to their preference. The preset scenarios are Normal, Speech, Classic, Rock and POP

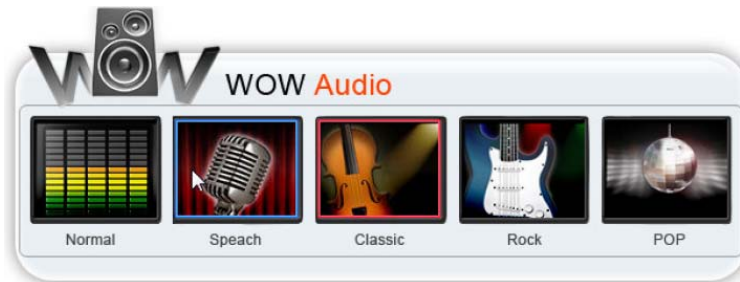

Figure 04: WOW Audio Configuration Dialog

#### Main Function

1. **Normal:** Presents the sound based on the factory default settings
2. **Speech:** Provides users the sound in enhancing human-voice frequency portions to present the sound more clear.
3. **Classic:** Provides users the sound in moderate to present the characteristics of the classics music.
4. **Rock:** Provides users the sound in moderate to present the characteristics of the Rock music.
5. **POP:** Provides users the sound in by enhancing mid-range frequency portions to present the sound without extreme high tone or high bass.

### 3.3.2 WOW Video

#### Scenario

WOW Video is a setting assortment for Audio conditions preset in Color Defines, Resolutions and Viewing Sizes that offer users a chance to select the most-fit scenario according to their preference.

The preset scenarios are **Normal**, **Office**, **Photo**, **Movie** and **User Define**. Define. The User Define option provides user an advanced chance to customize their personal scenario.

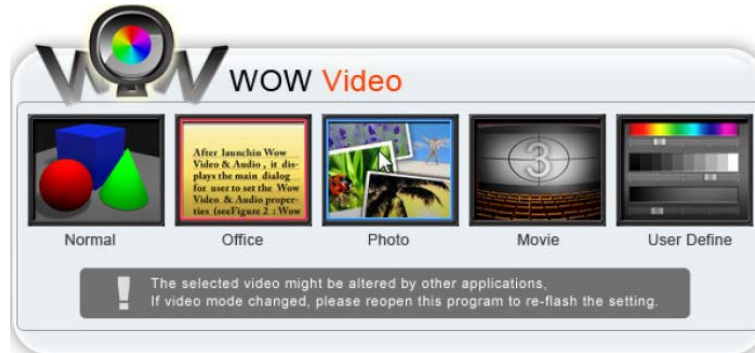

Figure 05: WOW Video Configuration Dialog

#### Main Functions

1. **Normal**: Presents the graphics based on the factory default settings
2. **Office**: Provides users the graphics in detail to present the character/letter clearer.



Figure 06: Comparing to Normal mode (circle right), Office mode (circle left) provides sharper edges on letters for better readability

3. **Photo**: Provides users the graphics in enhanced color to present the picture more saturated.
4. **Movie**: Provides users the graphics in dimmer to present the movie in a condition more suitable for longer period watching.



*Figure 07: Photo mode (circle left) provides higher details on objects, While Movie mode (circle right) provides lower.*

5. **User Define:** Allows users to have their own unique system setting according their preference.

1. To click the “Right button” of touch pad to setup the detail settings of the Wow video scheme.

2. There are 4 options to select in “Color Channel” Click on: **Red, Green and Blue.** Users can set Gamma, Contrast and Brightness for each color channel separately.



*Figure08: Video Scheme Details Dialog*

## 3.4 Depth Security Control

### 3.4.1 Entrance Guard

#### Scenario

This feature provides an auto logon mechanism to your MS Windows system by utilizing the built-in webcam to recognize the face of users who intend to logon to the system. It secures the exposure of the IDs and passwords, as well as to make the logon very easy and speedy.

Users power on the laptop and the system automatically enable the built-in webcam and its database for a security check to see if the user has been authorized to allow to get into the system or not.

#### Main Functions

There are 3 main applications in the function page there are Account Management, IM Password Wizard and Advanced Settings.



Figure 09: Entrance Guard Dialog

#### 1. Account Management

##### (1) Create New Account

Users can manage the Entrance Guard accounts via this function. Users can use the webcam to capture new faces, and then setup new security password to create new user account.

##### (2) Delete Account

Users can delete the current running Entrance Guard account (Self-delete).

##### (3) Update Account

Users can update the information of current accounts, such as new face or new security password.



Figure 10: Account Management Dialog

### 2. IM Password Wizard

This function provides automatic and easy logon to 5 popular real-time web based communicators, they are "Windows Live Messenger", "Yahoo! Messenger", "Skype", and "QQ" by presetting the logon information within.



Figure 11: IM Password Wizard Dialog

### 3. Advanced Settings

In this setting page, users can find more advanced information and settings for experienced users.

#### (1) Password Management

Users can see what their preset logon information. Users can do some changes including delete or correct field data.

#### (2) Option

Users can change the default setting on some preset Entrance Guard behaviors.

#### (3) Event log

Users can review the records of logon actions to verify dialog appear event. If the event was successful, it only shows text to inform users. If the event was fail, it shows the face image on the box below for demonstration.





Figure 12: Advanced Settings Dialog

## Operation Procedure

### Create New Account

1. Click on **“Account Management”**, screen will change to dialog below. (Figure 13), Click on **“Create New Account”** You can start to create a new account



Figure 13: Entrance Guard-Setup (1)

2. Input user's windows password to create a new Account. Press **“OK”**. (Figure 14)



Figure 14: Entrance Guard-Account Training dialog

3. Counting backwards for 5 seconds, System will catch the face information through the webcam used as data of the account. (Figure 15)
4. When face capturing users' faces must stay close to webcam and avoid rocking their faces in order to catch the best image information.
5. In order to get the best result, users shall need to move their face in the yellow frame.
6. If the face image been detected well, the green square will appear and the webcam will capture the face in the green frame.
7. Otherwise, the red frame will appear when face detection is unsuccessful. Users need to keep moving their face for a best detect result.



*Figure 15: Entrance Guard Account Training Dialog*

8. After face image verification, users will be asked to key-in the security password. (Figure 16)



*Figure 16: Security Password Setting Dialog*

9. User can store the security password in the proper location. (Default or customized) (Figure 17)

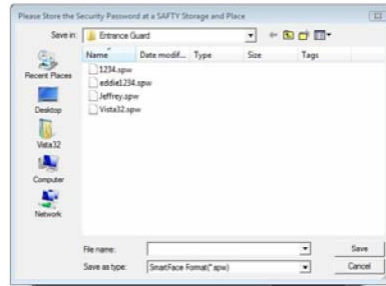

Figure 17: Security Password Saving Dialog

After the whole new Entrance Guard account creation procedure has been completed, user can click on the “Finish” button to saved and apply to the program. (Figure 18)



Figure 18: Account Creation Finish Dialog

Delete Account

Click on “**Delete Account**”, Face Authentication will first detect face to verify user identity and then delete account.



Figure 19: Face Authentication Dialog

Update Account

Click on “**Update Account**” System will catch the face information through the webcam used as data of the account again.

### 3.4.2 Smart Watchdog

#### Scenario

Smart Watchdog is a monitoring application that utilizes webcam function for extended service to users.

By using the built-in webcam, the Smart Watchdog can detect the presence of the users for an advanced power management and enhance the security of the data inside the laptop from spying.

#### Main Functions

(1) Monitoring

The Smart Watchdog will use webcam to detect if the users are still in front of system, if users has been left for a certain period of time, the Smart Watchdog will tell system for next instruction that user's pre-defined.

(2) Power Saving

Smart Watchdog can instruct system to go into either "Standby" or "Hibernation" by following the user preset watching criteria to save the power for longer time operation. Depends on the user using behavior, an average estimation around 10 % power saving would be a reference.

(3) Security Enhancement

Smart Watchdog secures the data from spying or illegal use on when the users are not around.

(4) Standby Time Setting

This feature is for setting the time period before system will go into Standby mode.



Figure 20: Smart Watchdog – System Standby Screen

(5) Hibernate Time Setting

This feature is for setting the time period before system will go into Hibernate mode.



Figure 21: Smart Watchdog – System Hibernate Screen

### Operation Procedure

1. Click on “**Smart Watchdog**” icon under “**Smart Watchdog**” folder and dialog shown.
2. The Smart Watchdog dialog appears for further feature selection.
3. To active the monitoring webcam, users can select to set either the time period for getting into “Standby” or “Hibernate”.
4. The time period before go into Standby can be set from 15 seconds to 5 minutes in 7-segment settings. Users can also set the time as “Never”.
5. The time period before go into Hibernate can be set from 1 minute to 10 minutes in 5-segment settings. Users can also set the time as “Never”.

### 3.4.3 Safety Guard

#### Scenario

This is a compound technology by the Video Tracing through webcam through Digital Microphone. Safety only needs webcam and Microphone.

Users can utilize this feature for safety assurance or other monitoring applications.

#### Main Functions



##### 1. Tracing Mode



After launch Safety Guard, it starts at the “**Tracing**” mode.





Figure 22: Safety Guard Tracing Mode

Press “” button to start tracing process, Safety Guard begin to guard your properties. If abnormal behavior is detected, Safety Guard starts to record and save the abnormal frames in the storage.

Press “” or “” button can pause or stop the tracing process.

 **Normal:** Set the tracing sensitivity to normal.  
 **High:** Set the tracing sensitivity to high level.

 **Time:** Limit the length of the recording file.  
 **Space:** Limit the size of the recording file.

**None:** No limitation.

##### 2. View Records Mode

In “**View Records**” mode, user can review the abnormal files that were recorded at tracing process.

The files are stored in the folder at “**C:\Users\{user account}\Documents\Safety Guard\AVStream\**”.



Figure 23: Safety Guard View Records Mode

Press “▶” button to play the file, “⏸” and “■” button for user to pause or stop it.

 **Delete Button:** Remove the item of the file list and delete it from storage.  
**Rename Button:** Rename for the files.

### 3. Schedule Arrangement

“**Schedule Arrangement**” dialog for user to arrange the tracing schedule.



Figure 24: Safety Guard Schedule Dialog

 **Schedule List:** List the tracing schedule items.  
**Delete button:** Delete the item in schedule list.

**Add New Schedule:** To add new tracing schedule, set date, time, sensitive, and limit condition, then press “Add to List” button.

### 4. Tracing Settings

Press “**Tracing Settings**” button then shows the “**Settings**” dialog this page for user to change the following settings: recording setting, user mail setting and SMS setting.

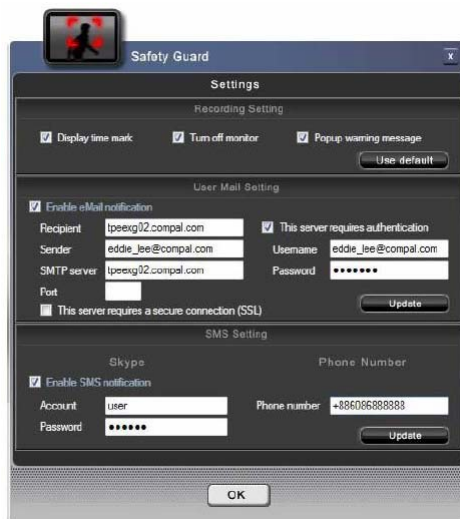

Figure 25: Safety Guard Settings Dialog



### Recording Setting

**Record time mark:** Add time mark on the video frame when recording.

**Blank the monitor screen:** Blank the monitor screen when start tracing.

**Warning message:** Pop up warning message when the abnormal frame detected.

Press the “Use default” button to enable all the three options.



### User Mail Setting

Safety Guard provides e-mail notification. When abnormal behavior is detected, Safety Guard will send a warning message with a snap to the designated e-mail address.

**Recipient:** E-mail address as the receiver of the mail.

**Sender:** Set the e-mail address as the sender of the mail.

**SMTP server:** Set the SMTP server for sending e-mail.

**Port:** Fill in the port number, which is provided by the SMTP service provider.

**SSL:** Check it if the server requires a secure connection.

**Authentication:** Fill in the username and password if the server requires authentication.

To save the changed settings, press the “**Update**” button.

### SMS Setting

Safety Guard provides SMS notification. User can receive a short message by mobile phone when the abnormal behavior is detected.

To save the changed settings, press the “**Update**” button.



To utilize SMS notification, user must have a Skype account first. And Skype must be installed in the system.

For more information about Skype SMS, please refer to the Skype website ([www.skype.com](http://www.skype.com)).

## 3.5 User Friendly

### 3.5.1 Wireless Switch

#### Scenarios

Users set the Wireless Switch preference. Only when Bluetooth and WLAN (802.11x) devices both exist, users can adjust their preference.

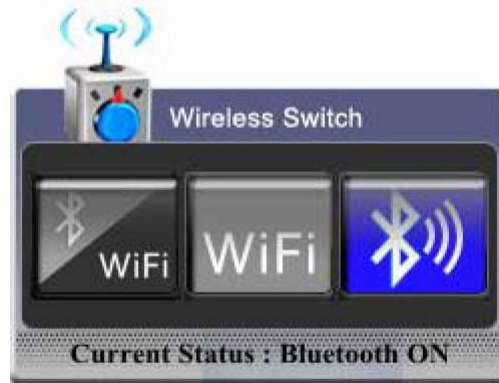





Figure 26: Wireless Switch Configuration Dialog

#### Operation Procedure

- (1)  Apply both Bluetooth and WLAN (802.11x) devices.
- (2)  Apply Bluetooth device.
- (3)  Apply WLAN (802.11x) device.

After selected, it will take effect by press “**Enter**” keyboard keypad immediately or configurations will apply after 4 seconds.

You can also click the expected item by mouse cursor then it will apply the configurations immediately.

-  If you want to turns off both devices, please switch the “kill switch”  
If “kill switch” turns off, both devices are all disabled.

## 3.6 Project communication

### 3.6.1 EzRemote

#### Scenarios

EzRemote supports only Windows Vista and later



Figure 27: Launch EzRemote from Program DJ

#### Main Functions

1. Configure Free  
Configure Free function provide user can set two things.
  - Switch condition, user can select Signal Strength or Preferred Network in switch condition.
  - Wireless LAN Type, include "Limited or no connectivity" Wireless Network



Figure 28: Setting Dialog



2. Scan and Connect  
System will scan and connect Access Point manually or automatically
3. Location Base



Figure 29: Location Base

It will display some information as follow (see Figure 29: Location Base)

- Access Point SSID
- Signal range
- Preference or non-preference network
- Require Network Key

  P key or WPA key

if user had logon and used this Wireless Network, it will show 

 Please select the "SAVE" item when use the Wireless Network

User can double click the Wireless Network icon and login it. The logon dialog is provided by OS. (See Figure 30: Logon dialog of Wireless Network)

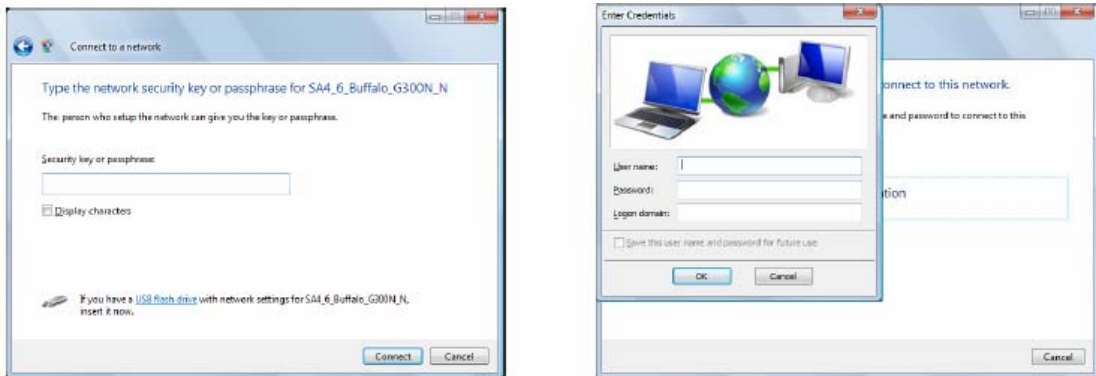

Figure 30: Logon dialog of Wireless Network

#### 4. Auto Switch APs

When current signal of Access Point is less than 50%, system will base on the setting to switch to other Access Point

#### 5. WLAN Messaging

EzRemote has a build-in instant message service which cans communication among ends in the same access point without identification. It can support at most 4 peers in the same chatting.



Figure 31: Contact list



Figure 32: Talk window

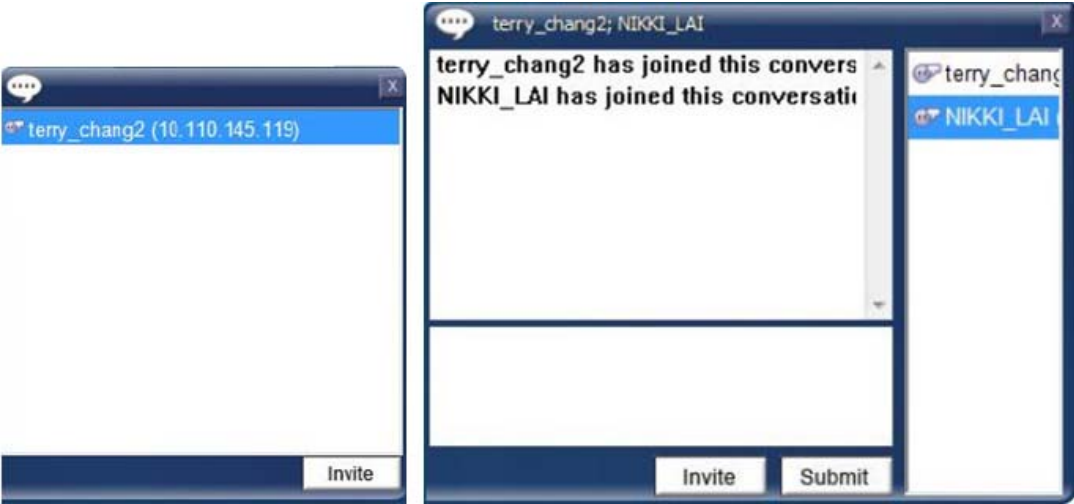

Figure 33: Invite to the chatting

### 3.6.2 EzTube

#### Scenarios

Need the web site of user when you want to upload image or video to Yahoo. So if this product wants to support it, we need to prepare a web site with 24-hour service for user. Therefore this product doesn't support it.

The famous web site-Wretch in Taiwan doesn't provide the API. Therefore this product doesn't support it

Video only support WMV format, image support GIF, JPG and BMP file format.

#### Main Functions

##### 1. Recording and Play

Some record product is too complicated, user may just need a simple way to record and capture. It provides one key to record or capture.

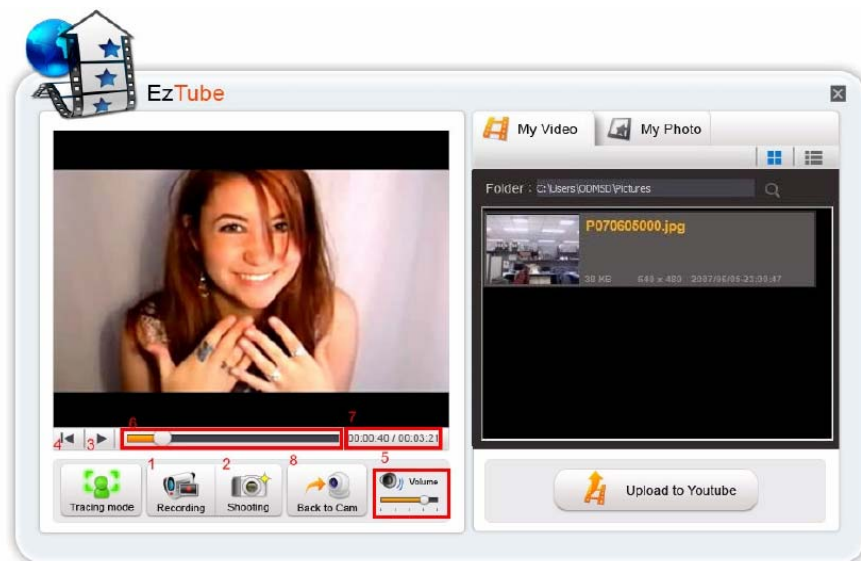

Figure 34: Main dialog

##### 2. Webbing

Allow user can upload video or image to YouTube or Flickr popular web site.

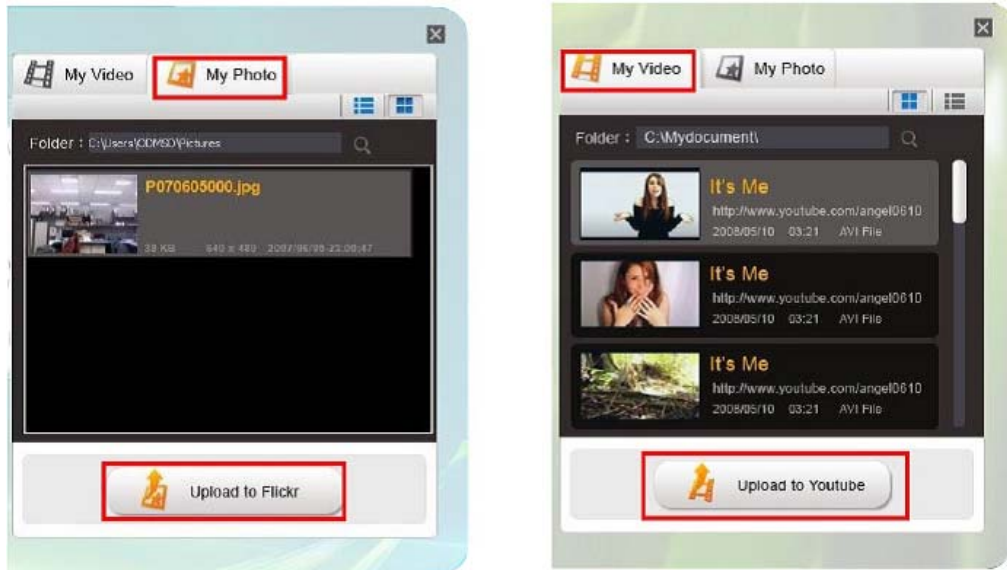

Figure35: Upload to special web site

### 3. File Manager

If user record video or capture image via this system, system will follow file naming rule to add file. This function doesn't support rename and delete.

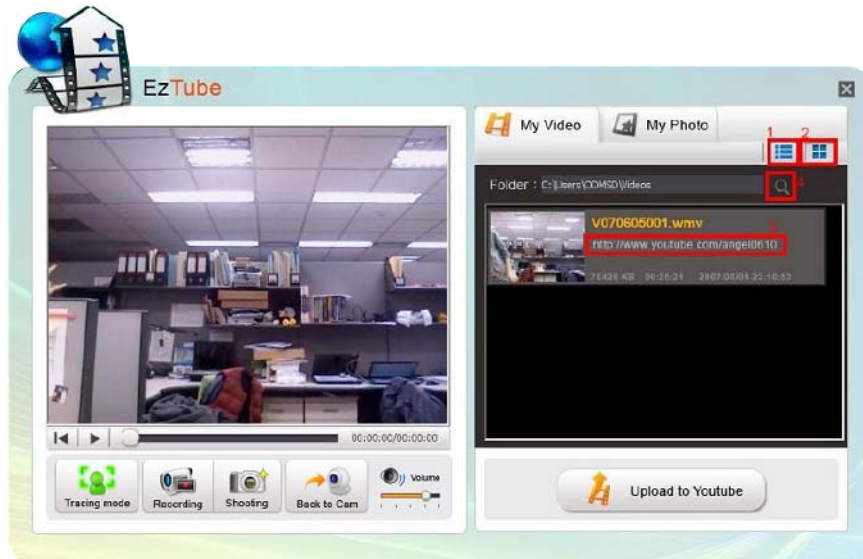

Figure 36: URL in Video mode





**Chapter 4**  
**Caring for Your Notebook**

## 4.1 Caring for Your Notebook

- Cleaning Your Notebook and Keyboard
- Cleaning the Display
- Cleaning the Touch Pad
- Cleaning the CD/DVD Drive
- Precautions

#### 4.1.1 Cleaning Your Notebook and Keyboard

Shut your notebook down, turn it off and disconnect it from the electrical outlet and any external devices, such as the printer.

Remove the battery pack.

Use the brush attachment of your vacuum cleaner to gently remove dust from your notebook's openings and keyboard.

Use a slightly moist soft, lint-free cloth to wipe your notebook and keyboard. *Use only the water or the recommended computer cleaner.*

#### 4.1.2 Cleaning the Display

Shut your notebook down, turn it off and disconnect it from the electrical outlet and any external devices, such as the printer.

Remove the battery pack.

Use a slightly moistened soft, lint-free cloth to wipe your notebook's display. *Use only the water or the recommended computer cleaner.*

#### 4.1.3 Cleaning the Touch Pad

Shut your notebook down, turn it off and disconnect from the electrical outlet and any external devices, such as the printer.

Remove the battery pack.

Use a slightly moistened soft, lint-free cloth to carefully wipe the Touch Pad, being careful not to allow the moisture into the gaps of your notebook. *Use only the water or the recommended computer cleaner.*

#### 4.1.4 Cleaning the CD/DVD Drive



Never touch the lens. Use only the compressed air to clean the lens.

If you encounter the difficulty in playing CDs or DVDs, including skipping over, please clean the unlabelled side of the disc with a soft, lint-free cloth or use the commercial product.

### 4.1.5 Precautions

- Do not spill the liquid on the keyboard. If the liquid is spilt on the keyboard, turn your notebook off immediately. Leave off overnight to let it completely dry out before using it again.
- Do not turn off your notebook if the drive light indicates the drive is active. Turning off your notebook while it is reading from or writing to a disk may damage the disk, the drive, or both.
- Keep your notebook and disks away from the objects that generate the strong magnetic fields, such as the stereo speakers. Information on disks is stored magnetically. Placing the magnet too close to the disk can erase the important files.
- Scan all new files for viruses. This precaution is especially important for the files you receive via email, disk or download from the Internet. You will need the special program to scan for viruses. For further information, please contact with your notebook dealer.
- To ensure HDD function and the integrity of the saved data, please follow the instructions below:
  - ◆ Do not power off.
  - ◆ Protect your notebook from any impact during its operation.
  - ◆ Do not use your notebook during the transportation such as in the car.
  - ◆ Do not put your notebook in the car if it is directly exposed under the sun.
  - ◆ Use the AC adapter coming with the package instead of other adapters.

## 4.2 Traveling

- Identifying Your Notebook
- Packing Your Notebook
- Traveling Tips
- If Your Notebook is Lost or Stolen

### 4.2.1 Identifying Your Notebook

Attach a nametag or business card to your notebook, or use the permanent marker or stencil to write a unique identifying mark (such as your driver's license number) on the case.

Create a file on the Desktop called **if found**. Place information such as your name, address, and telephone number in this file.

Contact your credit card company to ask if it offers coded identification tags.

### 4.2.2 Packing Your Notebook

- Remove any external devices attached to your notebook and store them in a safe place.
- Fully charge the main battery and any spare batteries you plan to carry with you.
- Turn off your notebook or put the computer into hibernate mode.
- Disconnect the AC adapter.
- Remove any extraneous items, such as paper clips, pens, and papers, from the keyboard and then close the display.
- Pack your notebook and accessories in their carry case.
- Avoid packing the computer with items such as shaving cream, colognes, perfumes, or food.
- Protect your notebook, the batteries, and the hard drive from hazards such as extreme temperatures, dirt, dust, liquids, or overexposure to sunlight.
- Pack your notebook so that it does not slide around in the trunk of the car or in an overhead storage compartment.



When traveling in the air, never check in your notebook as baggage.

### 4.2.3 Travel Tips

- If you are traveling abroad, you can carry the proof of ownership—or of your right for using your notebook if it is company-owned—to speed your passage through customs. Investigate the customs regulations of the countries you plan to visit and consider acquiring an international carnet (also known as a merchandise passport) from your government.
- Ensure that you know which electrical outlets are used in the countries you will visit, and prepare the appropriate power adapters.
- Check with your credit card company for information about any kinds of emergency travel assistance it offers to the users of the portable computers.
- When traveling in the air, please ensure that you have a charged battery available in case you are asked to turn on your notebook.
- Before using your notebook on the airplane, please verify that such usage is permitted. Some airlines forbid the use of electronic devices during the flight. All airlines forbid the use of electronic devices during taking-off and landing.



Never pass your notebook through a metal detector. Send it through an X-ray machine, or have it manually inspected.

#### **4.2.4 If Your Notebook is Lost or Stolen**

Call a law enforcement agency to report your notebook lost or stolen. Ask that a case number be assigned and write down the number, along with the name, address, and telephone number of the law enforcement agency. If possible, please obtain the name of the investigating officer.

If your notebook belongs to the company, notify its security office.



# **Chapter 5**

## **Peripherals**

## 5.1 Adding and Removing SD/MMC/MS Cards

Before removing an SD/MMC/MS card, stop it running from the configuration utility on the taskbar. Failure to do so could result in the data  loss.

Insert the SD/MMC/MS card into the card reader slot.

To remove the SD/MMC/MS card, please push it in gently and then it ejects automatically.

## 5.2 Memory Modules

You can add more memory modules to your notebook to improve its performance.

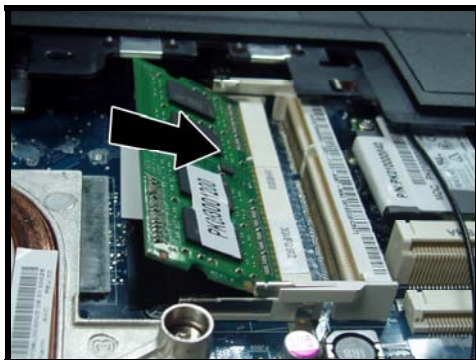
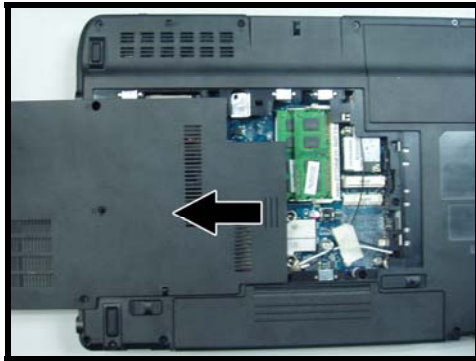

### To install a memory module:

Make sure the computer is turned off.

Remove the screw securing the CPU thermal cover.

There are two memory module ports. Place the new memory module in the slot, matching up the notch along its connector rim with the tooth in the connection slot.

When the module is secured, please press down gently until it snaps into place.



Depending on how much additional memory you require, you may need to replace the original memory module.

### To remove a memory module:

Make sure the computer is turned off.

Remove screw securing the CPU thermal cover.

Pop out both silver latches holding the memory module into place. The module pops up.

Grasp the outer edges of the memory module with the thumb and forefinger, and then gently remove it.



## **Chapter 6**

### **The Power System (Windows 7)**

## 6.1 Power Management

- Managing Your Notebook's Power
- Power Management Modes
- Power Options Properties
- Speed Step

### 6.1.1 Managing Your Notebook's Power



See **6.2 Battery** for more information on getting the best performance from the battery packs.



Use your notebook connected to an electrical outlet as often as possible as the battery life expectancy is affected by the number of times it is charged.

Your notebook comes with built-in power management. You can configure it through the **Power Options** program in the **Control Panel**, to sleep, hibernate, and wake according to the specific situations.

The **Advanced** settings can be accessed via **Start > Control Panel > System and Maintenance > Power Options**.

On the **Select a power plan** page, click **Change plan setting** under the plan that you want to change.

Click **Change advanced power settings**. Expand the **Power buttons and lid** category to configure the settings.

When leaving your notebook unattended for the long period, place it in Standby or Hibernate Mode. You can exit either power management mode by pressing the **Power Button**.

### 6.1.2 Power Management Modes

#### 6.1.2.1 Sleep Mode

This mode conserves power by switching off the hard drive and display after the preset period of inactivity (a time-out). When **Sleep Mode** is exited, your notebook will return to the same operating state it was before entering sleep.



In Sleep Mode, if your notebook loses power from both of the electrical outlet and the battery, the data in your notebook may be lost.

To enter **Sleep Mode** in Windows 7:

**Start > ► > Sleep**. Or

Set your notebook to enter **Sleep Mode**, as you:

- Close the lid of your notebook
- Press the power button
- Press the start menu power button

The settings can be accessed via **Power Options: Advanced settings** window. See **6.1.1 Managing Your Notebook's Power**

To exit Sleep Mode, please press the **Power Button**. You cannot exit **Sleep Mode** by using any key or the Touch Pad. For more information on **Sleep Mode**, see **2.1 Turning Your Notebook On and Off**

### 6.1.2.2 Hibernate Mode

In **Hibernate Mode**, power is conserved by system data being copied to the hard drive, and your notebook is completely shut down. While **Hibernate Mode** is exited, your notebook will return to the same operating state it was in before entering **Hibernate Mode**.

**Hibernate Mode** can be enabled/disabled in the **Power Options** window.

Your notebook will go into **Hibernate Mode** if the battery charge level becomes critically low.

Depending on how you set the **Power Management Options** in the **Power Options** window, use one of the following methods to enter **Hibernate Mode**:

- Close the lid of your notebook
- Press the power button
- Press the Start menu power button
- **Start > ► > Hibernate.**

The settings can be accessed via Power Options: Advanced settings window.

See **6.1.1 Managing Your Notebook's Power**.

To exit **Hibernate Mode**, press the Power Button. You cannot exit **Hibernate Mode** by using any key or the Touch Pad. For more information about **Hibernate Mode**, see **2.1 Turning Your Notebook On and Off**

### 6.1.3 Power Options Properties

To access the **Windows Power Options** window:

**Start > Control Panel > System and Maintenance > Power Options**

#### 6.1.3.1 Select a power plan

Windows 7 provides three preset power plans-Balanced, Power saver, and High performance. Each plan has the different time-out settings for turning off the display and entering **Sleep Mode**. You do not need to make any further adjustments to set the performance level.

To change setting for the plan, click the following three items on the left pane of the Power Options window.

- Choose when to turn off the display
- Change when the computer sleeps
- Adjust the display brightness

After selecting a plan, you can see the percentage of battery charge remaining and active power plan by moving the mouse pointer over the battery meter icon on the taskbar.

For more information on changing advanced power settings, see the **Windows Help and Support**.



To maximize battery power, use the Power saver plan.



### 6.1.3.2 Power buttons and password protection

Select **Require a password on wakeup**, **Choose what the power buttons does**, or **Choose what closing the lid does** from the left pane of the Power Options window. There are two main settings in this section:

- Power button and lid settings
- Password protection on wakeup

Depending on your operating system, program the following functions by clicking an option from the corresponding pull-down menu in **Advanced settings** window, and then clicking **OK** to save your settings and close this window.

For more information on accessing the **Advanced settings** window, see **6.1.1 Managing Your Notebook's Power**.

Set the computer to **Do nothing / Sleep / Hibernate / Shutdown** when you press the power button.

- Set the computer to **Do nothing / Sleep / Hibernate / Shutdown** when you close the laptop lid
- Select the password requirement when the computer wakes from sleep.

### 6.1.3.3 Create a power plan

Besides three preset power plans offered in Windows 7, you can also customize your own power plan. Select **Create a power plan** on the left pane of the Power Options window to begin configuring your power settings.

### 6.1.4 Speed Step

Your notebook is equipped with SpeedStep technology to better manage power consumption. It changes the processor speed to find the best balance between your computing performance and power consumption needs. Higher speeds bring better performance, but the slower speed conserves more power.

In Windows 7, the processor's performance level depends on the **Power Scheme** you select (see **6.1.3 Power Options Properties**). You do not need to make any further adjustments to set the performance level. Each preset power scheme has different time-out settings for entering Sleep Mode, Hibernate Mode, shutting down the display, or turning off the hard drive.

For example, the Windows 7 automatically changes **SpeedStep Modes** depending on running the AC power or batteries in order to prolong the battery usage while still providing optimal performance.

You can also individually alter and save each of these settings and schemes if desired. Choose from the following three power plans that describe the desired relationship between power and performance.

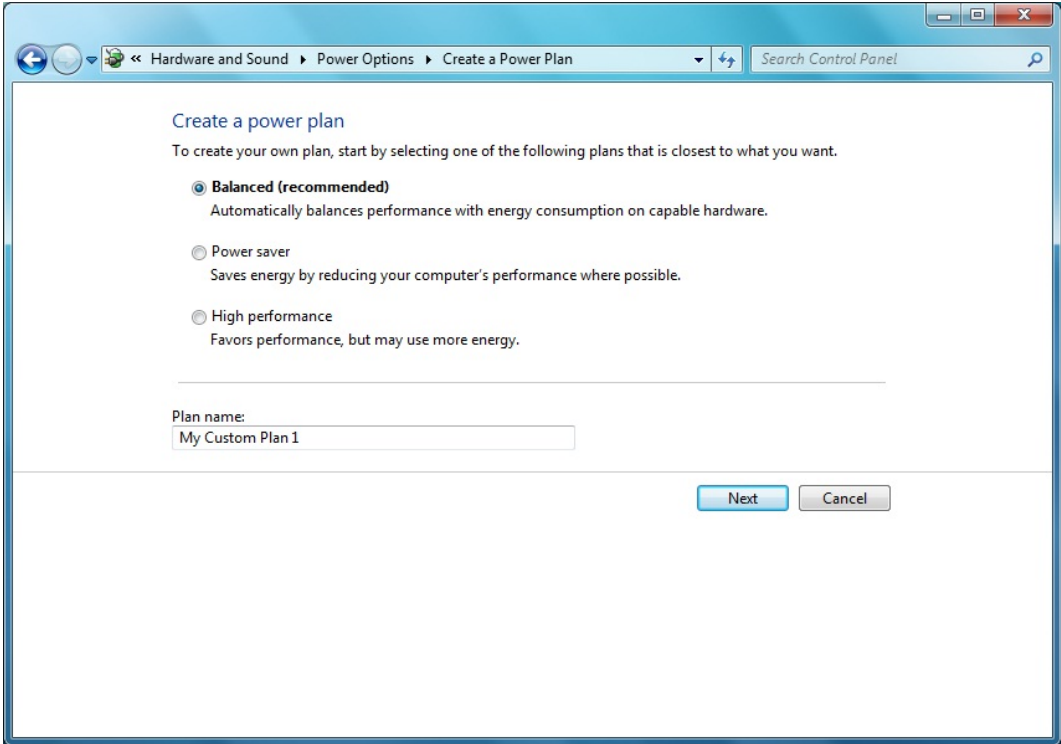

Windows 7 automatically chooses the **Speed Step Mode** to find the most appropriate speed for your processor according to the type of plan you choose and your current system demands

## 6.2 Battery

- Battery Performance
- Checking the Battery Charge
- Power Meter
- Low-Battery Warning
- Charging the Battery
- Removing a Battery
- Installing a Battery
- Storing a Battery
- Working With Extra Battery Packs
- Maximizing Battery Life

### 6.2.1 Battery Performance

The Battery Performance can be varied with on the different operating conditions. Your battery may last less time if you are running power-intensive programs, playing CDs or DVDs, or setting the high display-brightness.

The **Power Management Options** can be set to alert you when the battery charge is low.



Ensure any battery you use is compatible. Failure to do so may risk fire or explosion. For more details on purchasing compatible batteries, please contact your notebook retailer.





Batteries should never be disposed of the household waste. Contact your local waste disposal or environmental agency for advice on disposing of the used lithium-ion batteries.

### 6.2.2 Checking the Battery Charge

Battery Status	Indicator behavior
Charging	Flashes blue
Fully Charged	Solid blue
Critical Low	Amber > approximately 3 minutes left; system beeps

### 6.2.3 Power Meter

The power meter  indicates the remaining battery charge. When your notebook is running on battery power, you can double click the  icon on the taskbar to check the remaining battery charge. If you want to know more details about how to make the icon appear on the taskbar if it is not already, please see **6.1 Power Management**

### 6.2.4 Low-Battery Warning



After a low-battery warning, save your work immediately and then connect your notebook to an electrical outlet. Hibernate Mode will begin automatically if the battery runs completely out of power.

You will hear the low-battery warning when the battery charge is approximately 90 percent depleted. Your notebook will beep once, indicating approximately 10 to 15 minutes of battery operating time remain. If you do not connect your notebook to alternative power source during that time, there will be a periodic beep. Your

notebook will automatically enter **Hibernate Mode** if battery charge reaches a critically low level. For more information, see **6.1 Power Management**

### 6.2.5 Charging the Battery



When connected to an electrical outlet, a completely discharged 4-cell battery needs to be charged in 3.5 to 12 hours, and a 8-cell battery in 5 to 12 hours (depending on whether your notebook is on or off and what programs are running). You can leave the battery in your notebook as long as you like. The battery's internal circuitry prevents the battery from overcharging.

Before using the battery for the first time it must be charged. Connect your notebook to an electrical outlet and allow the battery to fully charge, indicated by the battery indicator light on the front panel of your notebook.



Once a battery pack is fully charged for the first time, please use your notebook on battery power until the battery discharges completely. This will extend the battery life, and helps to ensure the accurate monitoring of the battery capacity.

If necessary, the battery will be charged whenever your notebook is connected to an electrical outlet.

The battery will not be charged if it or your notebook is too hot to use. If this situation occurs, the battery indicator will light amber. Disconnect your notebook from any electrical outlet, and allow it and the battery to cool down. You can then reconnect your notebook to the electrical outlet and charge the battery. The battery indicator will also light amber if the battery is bad and needs replacing.

### 6.2.6 Low-Battery Warning



After a low-battery warning, save your work immediately and then connect your notebook to an electrical outlet. Hibernate Mode will begin automatically if the battery runs completely out of power.

You will hear the low-battery warning when the battery charge is approximately 90 percent depleted. Your notebook will beep once, indicating approximately 10 to 15 minutes of battery operating time remain. If you do not connect your notebook to alternative power source during that time, there will be a periodic beep. Your notebook will automatically enter **Hibernate Mode** if battery charge reaches a critically low level. For more information, see **6.1 Power Management**.

### 6.2.7 Removing the Battery

Before removing the battery, ensure your notebook is turned off.

Move the battery lock to switch to the right (Unlock position).  
Slide and hold the battery to release latch.  
Remove the battery.

### **6.2.8 Installing a Battery**

Slide the battery into the bay.  
Press it into place gently but firmly until the latch locks it into place.  
Slide the battery lock to switch back to the locked position.

### **6.2.9 Storing a Battery**

If storing your notebook for an extended period of time, please remove the battery. Fully charge the battery before using your notebook again.

### **6.2.10 Working With Extra Battery Packs**

If you spend a lot of time traveling or work without connecting your notebook to an electrical outlet, it may be a good idea to carry the additional battery packs so you can quickly replace a discharged battery and continue working.

### **6.2.11 Maximizing Battery Life**

A battery can be recharged many times, but over time it will lose its ability to hold a charge. To maximize the battery life:

- If you are not using your notebook for a long period, please remove the battery.
- If you have a spare battery pack, please alternate the batteries.
- Ensure your notebook is off when replacing the battery.

Store the spare battery packs in a cool, dry place, out of the direct sunlight.



# **Chapter 7**

## **The BIOS Setup Program**



### 7.1 Introduction

The BIOS (Basic Input and Output System) Setup program is a menu driven utility that enables you to make changes to the system configuration and tailor the operation of your notebook to your individual work needs. A ROM-based configuration utility displays the system's configuration status and provides you with a tool to set system parameters. These parameters are stored in nonvolatile battery backed-up CMOS RAM, which saves this information even when the power is turned off. When the computer is turned back on, the system is configured with the values found in CMOS. Via easy-to-use menus, you can configure such items as:

- Boot devices

The settings made in the Setup program intimately affect how your notebook performs. It is important, therefore, to first understand all the available options, and second, to make settings appropriate for the way you use your notebook. This chapter guides you through the Setup program by providing the clear explanations for all Setup options.

A standard configuration has already been set in the Setup program by the factory technicians. However, eventually you may want to customize your system to suit your own performance needs. It is recommended that you read this chapter and become familiar with the configurations that can be made in the BIOS.

The next section explains how to move around in the Setup program, as well as how to specify and save your new settings. A brief discussion of the optional settings among the different submenus follows.

## 7.2 Navigating through the BIOS Setup Program

- Accessing the BIOS Setup Program
- Launching Submenus
- Saving Changes and Exiting the Setup Program

The Setup program has been designed to make it as easy to use as possible. It is a menu driven program, which means you can scroll through the various directories and make your selections among the various predetermined choices. If you accidentally configure a setting, use the BIOS hot keys to return to the previous value. The hot keys are discussed in more detail later in this chapter.

When turning on your notebook for the first time you may be prompted to run the BIOS Setup program. A warning message may appear on the screen if the hardware configuration is changed or the POST fails. This message will inform you of any errors or invalid settings and prompt you to run the Setup program to correct the problem.

Even if you are not prompted by a message instructing you to use the Setup program, at some time in the future you may want to change the configuration of your notebook. It will then be necessary to reconfigure your system using the Setup program so that your notebook can recognize these changes.

The list below gives a few examples of reasons why you may want or need to run the BIOS Setup program.

- You have set up your notebook for the first time and you got a message stating that you should run the BIOS Setup program.
- You want to redefine the communication ports to prevent any conflicts.



The few examples listed above are by no means complete.

## 7.2.1 Accessing the BIOS Setup Program

The setup function can be invoked by pressing F2 when “Press <F2> to enter Setup” message is prompted on the bottom of screen during POST.

During setup, all Fn function keys and power saving functions are disabled.

### Information Menu

This Menu will show the System Information such as CPU Type and Speed, HDD Model Name and Serial number, ODD Model Name, System BIOS Version, EC FW Version, Serial Number, and UUID and so on.

InsydeH20 Setup Utility						
Main	Security	Boot	Exit			
System Time		[XX:XX:XX]		Details see the following Help Information		
System Date		[XX/XX/XXXX]				
Processor Type		Type, XXXGHZ				
Total Memory		XXX MB				
Quiet Boot		[Enabled]				
System BIOS Version:		X.XX.XX				
EC FW Version:		V.XX.XX				
Serial Number:		XXXXXXXXXX				
UUID:		XXXXXXXXXX				
F1 Help	↑↓ Select Item	F5/F6 Change Values	F9 Setup Defaults			
Esc Exit	←→ Select Screen	Enter Select ▶ SubMenu	F10 Save and Exit			

### The Menu Bar

The top of the Setup screen has a menu bar with the following selections:

- Main** Allows the user to specify standard IBM PC AT system parameters.
- Security** This menu shows the security setting, such as TPM, Supervisor Password, Power on Password and HDD Password.
- Boot** Allows the user to specify the order in which your notebook is to check for a device to boot the system.
- Exit** Allows the user to save CMOS setting and exit Setup.

To move between menu bar items, use the [◀] and [▶] arrow keys until the desired item is highlighted. For example, if you want to move from the *Main menu* to the *advanced menu*, press the right arrow key [▶] once.

### Item Specific Help

To the right of the Setup screen, you will notice an item specific help bar. For each item that you select on the menu, the bar informs of its specific function as well as the hot keys related to that item and/or submenu.

### 7.2.2 Launching Submenus

A submenu contains the additional options for a field parameter. To call up a submenu, simply move the highlight to the desired field and press the [Enter] key. The submenu opens.

If you are a first time user or are not familiar with BIOS Setup program, it is highly recommended that you take a few minutes to familiarize yourself with each of the submenus and their corresponding functions. If you accidentally make unwanted changes to the current configuration, go to the *Exit menu* and select **Discard Changes**.

### 7.2.3 Saving Changes and Exiting the Setup Program

Refer to the *Exit Menu* section of this chapter for the detailed information on saving changes and exiting the Setup program.

## 7.3 The Main Menu

When the Setup program is accessed, the Information screen appears. It displays the following pieces of information regarding your current system:

InsydeH20 Setup Utility					
Main	Security	Boot	Exit		
System Time		[XX:XX:XX]		Details see the following Help Information	
System Date		[XX/XX/XXXX]			
Processor Type		Type,XXXGHZ			
Total Memory		XXX MB			
Quiet Boot		[Enabled]			
System BIOS Version:		X.XX.XX			
EC FW Version:		V.XX.XX			
Serial Number:		XXXXXXXXXX			
UUID:		XXXXXXXXXX			
F1 Help	↑↓ Select Item	F5/F6 Change Values	F9 Setup Defaults		
Esc Exit	←→ Select Screen	Enter Select ▶ SubMenu	F10 Save and Exit		

### System Time and System Date

The hour is displayed with 24-hour format. The values set in these two fields take effect immediately.

### Processor Type

This field shows CPU type and speed.

### Total Memory

This field reports the memory size of the extended memory with an integer in the system.

### Quick Boot

Allows InsydeH20 to disable or enables booting in Text Mode.

### Help information

#### System Time

[hh:mm:ss] This is the help for the hour field. Valid range is from 0 to 23.  
INCREASE/REDUCE: +/-.

[hh:mm:ss] This is the help for the minute field. Valid range is from 0 to 59.

INCREASE/REDUCE: +/-.

[hh:mm:ss] This is the help for the second field. Valid range is from 0 to 59.

INCREASE/REDUCE: +/-.

### **System Date**

[mm:dd:yy] This is the help for the month field. Valid range is from 1 to 12.  
(Error checking will be done against month/day/year combinations that are not supported)

INCREASE/REDUCE: +/-.

[mm:dd:yy] This is the help for the day field. Valid range is from 1 to 31.  
(Error checking will be done against month/day/year combinations that are not supported)

INCREASE/REDUCE: +/-.

[mm:dd:yy] This is the help for the year field. Valid range is from 2000 to 2009.

(Error checking will be done against month/day/year combinations that are not supported)

INCREASE/REDUCE: +/-.

### **Quiet Boot**

Disables or enables booting in Text Mode

## 7.4 The Security Menu

This menu shows the security setting, such as TPM, Supervisor Password, Power on Password and HDD Password.

InsydeH20 Setup Utility				
Main	<b>Security</b>	Boot	Exit	
TPM Status		XXXXXXXX		Details see the following Help Information
TPM Operation		[No Operation]		
TPM Force Clear		[Enabled]		
Supervisor Password :		Clear		
Set Supervisor Password				
Power on Password		[Enabled]		
HDD Password Status		No Accessed		
Set HDD Password				
F1 Help	↑↓ Select Item	F5/F6 Change Values	F9 Setup Defaults	
Esc Exit	←→ Select Screen	Enter Select ▶ SubMenu	F10 Save and Exit	

### TPM Status

Show the TPM status: “Enable and Active” or “Disable and Deactive”

### TPM Operation

Enable/Disable TPM Function. This option will automatically return to No-Operation.

### TPM Force Clear

This item will show when the TPM Operation be set “Enable and Active”, used to enable/disable TPM Force Clear function.

### Supervisor Password

Show the Password status: Clear or Set

### Set Supervisor/HDD Password

Install or Change the password.

Notes: You only can set the User password after the Supervisor password is set.

### Power on Password

Enable or disable the Power on Password. You only can enable/disable Power on password after the Supervisor password is set.



### **HDD Password Status**

This item will show enable or disable HDD Password Status.

### **Help information**

#### **TPM Operation**

Enable/Disable TPM Function. This option will automatically return to No-Operation.

#### **TPM Force Clear**

TPM Force Clear Function

#### **Set Supervisor Password**

Install or change the password and the length of password must be greater than one word.

#### **Power on password**

Enable: System will ask input password on post time.

Disable: System will ask input pass-word when go to Setup Utility

#### **Set add Password**

Lock Harddisk and the length of password must be greater than one word.



## 7.6 The Exit Menu

InsydeH20 Setup Utility					
Main		Security		Boot	
				<b>Exit</b>	
Exit Saving Changes				Details see the following Help Information	
Exit Discarding Changes					
Load Optimal Defaults					
F1	Help	↑↓	Select Item	F5/F6	Change Values
Esc	Exit	←→	Select Screen	Enter	Select ▶ SubMenu
				F9	Setup Defaults
				F10 Save and Exit	

### Exit Saving Changes

Allows the user to save changes to NV Storage and reboot system. The following message is prompted when user press “Enter” on the item.

<u>Exit Saving Changes?</u>	
[Yes]	[No]

Yes: Save Changes, Exit SETUP and reboot

No: Back to previous screen

### Exit Discarding Changes

Allows the user to discard changes and continue the boot operation. The following message is prompted when user press “Enter” on the item.

<u>Exit Discarding Changes?</u>	
[Yes]	[No]

**Yes: Discard Changes and continue the boot operation**

**No: Back to previous screen**

### Load Optimal Defaults

Allows the user loads default values in CMOS Setup. The following message is prompted when user press "Enter" on this item:

<p><u>Load Optimal Defaults?</u></p> <p>[Yes]      [No]</p>
---

It still stay in Setup when press a key.

Help information

Exit Saving Changes

Exit system setup and save your changes.

Exit Discarding Changes

Exit system setup and without saving your changes.

Load Optimal Defaults

Load Optimal Defaults.