

# **ECS-9200/9100 GTX1050 USER Manual**

**Quad Core Intel® Xeon® / Core™ i7 Processor Embedded System  
with Intel® C236 Chipset & NVIDIA GEFORCE® GTX 1050 Ti/1050 Graphics  
High Performance, Independent Graphics, EN50155**

## Record of Revision

---

Version	Date	Page	Description	Remark
1.0	07/25/2017	All	Official Release	
1.1	11/03/2017	46-66	Update	

## Disclaimer

This manual is released by Vecow Co., Ltd. for reference purpose only. All product offerings and specifications are subject to change without prior notice. It does not represent commitment of Vecow Co., Ltd. Vecow shall not be liable for direct, indirect, special, incidental, or consequential damages arising out of the use of the product or documentation or any infringements upon the rights of third parties, which may result from such use.

## Declaration of Conformity

**FCC** This equipment has been tested and found to comply with the limits for a Class A digital device, pursuant to part 15 of the FCC Rules. These limits are designed to provide reasonable protection against harmful interference when the equipment is operated in a commercial environment. This equipment generates, uses, and can radiate radio frequency energy, and if it is not installed and used in accordance with the instruction manual, it may cause harmful interference to radio communications. Operation of this equipment in a residential area is likely to cause harmful interference in which case the user will be required to correct the interference at his own expense.

**CE** The products described in this manual complies with all applicable European Union (CE) directives if it has a CE marking. For computer systems to remain CE compliant, only CE-compliant parts may be used. Maintaining CE compliance also requires proper cable and cabling techniques.

## Copyright and Trademarks

This document contains proprietary information protected by copyright. No part of this publication may be reproduced in any form or by any means, electric, photocopying, recording or otherwise, without prior written authorization by Vecow Co., Ltd. The rights of all the brand names, product names, and trademarks belong to their respective owners.

# Order Information

---

Part Number	Description
ECS-9240-GTX1050T	ECS-9200, NVIDIA GeForce® GTX 1050 Ti, 6 GigE LAN w/4 PoE <sup>+</sup> , 2 SSD Tray, 8 USB 3.0, 4 COM, 1 M.2, 1 M2DOM, 3 SIM, 32 Isolated DIO
ECS-9240-GTX1050	ECS-9200, NVIDIA GeForce® GTX 1050, 6 GigE LAN w/4 PoE <sup>+</sup> , 2 SSD Tray, 8 USB 3.0, 4 COM, 1 M.2, 1 M2DOM, 3 SIM, 32 Isolated DIO
ECS-9100-GTX1050T	ECS-9100, NVIDIA GeForce® GTX 1050 Ti, 2 GigE LAN, 2 SSD Tray, 8 USB 3.0, 4 COM, 1 M.2, 1 M2DOM, 3 SIM, 16 GPIO
ECS-9100-GTX1050	ECS-9100, NVIDIA GeForce® GTX 1050, 2 GigE LAN, 2 SSD Tray, 8 USB 3.0, 4 COM, 1 M.2, 1 M2DOM, 3 SIM, 16 GPIO

## Order Accessories

Part Number	Description
E3-1275 v6	7th Generation Intel® Xeon® E3-1275 v6 Processor (8M Cache, up to 4.20 GHz, 80W)
E3-1275 v5	6th Generation Intel® Xeon® E3-1275 v5 Processor (8M Cache, up to 4.00 GHz, 80W)
E3-1225 v5	6th Generation Intel® Xeon® E3-1225 v5 Processor (6M Cache, up to 3.70 GHz, 80W)
E3-1268L v5	6th Generation Intel® Xeon® E3-1268L v5 Processor (8M Cache, up to 3.40 GHz, 35W)
i7-7700	7th Generation Intel® Core™ i7-7700 Processor (8M Cache, up to 4.20 GHz, 65W)
i7-7700T	7th Generation Intel® Core™ i7-7700T Processor (8M Cache, up to 3.80 GHz, 35W)
i7-6700	6th Generation Intel® Core™ i7-6700 Processor (8M Cache, up to 4.00 GHz)
i7-6700TE	6th Generation Intel® Core™ i7-6700TE Processor (8M Cache, up to 3.40 GHz)
DDR4 16G	Certified DDR4 16GB 2133MHz RAM
DDR4 8G	Certified DDR4 8GB 2133MHz RAM
DDR4 4G	Certified DDR4 4GB 2133MHz RAM
PWA-280WB-WT	280W, 24V, 85V AC to 264V AC Power Adapter with 3-pin Terminal Block (7.62mm pitch), Wide Temperature -30°C to +70°C
PWA-160WB-WT	160W, 24V, 85V AC to 264V AC Power Adapter with 3-pin Terminal Block (7.62mm pitch), Wide Temperature -30°C to +70°C
VESA Mount	VESA Mounting Kit
DIN-RAIL	DIN Rail Kit
Rack Mount	2U Rackmount Kit
TMK2-20P-100	Terminal Block 20-pin to Terminal Block 20-pin Cable, 100cm
TMK2-20P-500	Terminal Block 20-pin to Terminal Block 20-pin Cable, 500cm
TMB-TMBK-20P	Terminal Board with One 20-pin Terminal Block Connector and DIN-Rail Mounting
3G Module	Mini PCIe 3G/GPS Module with Antenna
4G Module	Mini PCIe 4G/GPS Module with Antenna
WiFi & Bluetooth Module	Mini PCIe WiFi & Bluetooth Module with Antenna

# Table of Contents

<b>CHAPTER 1</b>	<b>GENERAL INTRODUCTION</b>	<b>1</b>
1.1	Overview	1
1.2	Features	2
1.3	Product Specification	2
1.3.1	Specifications of ECS-9240 GTX1050	2
1.3.2	Specifications of ECS-9100 GTX1050	5
1.4	Supported CPU List	7
1.5	Mechanical Dimension	8
1.5.1	Dimensions of ECS-9240 GTX1050	8
1.5.2	Dimensions of ECS-9100 GTX1050	8
<b>CHAPTER 2</b>	<b>GETTING TO KNOW YOUR ECS-9200/9100 GTX1050</b>	<b>9</b>
2.1	Packing List	9
2.2	Front Panel I/O & Functions	10
2.3	Rear Panel I/O & Functions	18
2.4	Main Board Expansion Connectors	26
2.5	Main Board Jumper & Deep Switch Settings	38
2.6	Ignition Control	42
<b>CHAPTER 3</b>	<b>SYSTEM SETUP</b>	<b>46</b>
3.1	How to Open Your ECS-9200/9100 GTX1050	46
3.2	Installing CPU	50
3.3	Installing DDR4 SO-DIMM Modules	53
3.4	Installing Mini PCIe Card	54
3.5	Installing CFast Card	55
3.6	Installing SIM Card	56

3.7	Installing SSD/HDD	57
3.8	Installing M.2	59
3.9	Installing M2DOM	60
3.10	Mounting Your ECS-9200/9100 GTX1050	62
<b>CHAPTER 4</b>	<b>BIOS SETUP</b>	<b>67</b>
4.1	Entering BIOS SETUP	67
4.2	Main	68
4.3	Advanced	68
4.4	Chipset	77
4.5	Security	82
4.6	Boot	83
4.7	Save & Exit	84
<b>APPENDIX A</b>	<b>Isolated DIO Guide</b>	<b>85</b>
<b>APPENDIX B</b>	<b>Software Functions</b>	<b>91</b>
<b>APPENDIX C</b>	<b>RAID Installation Guide</b>	<b>95</b>
<b>APPENDIX D</b>	<b>Power Consumption</b>	<b>99</b>
<b>APPENDIX E</b>	<b>Supported Memory &amp; Storage List</b>	<b>101</b>
<b>APPENDIX F</b>	<b>Graphics Performance</b>	<b>104</b>

# 1

## GENERAL INTRODUCTION

### 1.1 Overview

Vecow ECS-9200/9100 GTX1050 series is a workstation-grade compact integrated embedded system. Flexible LGA1151 Socket supports the workstation-grade Intel® Xeon®/Core™ i7 processor (Kaby Lake-S/Skylake-S) running with advanced Intel® C236 chipset and dual-channel DDR4 2133MHz ECC memory, up to 32GB capacity, independent NVIDIA GeForce® GTX 1050Ti/GTX 1050 graphics engine computing with advanced NVIDIA Pascal™ architecture, ECS-9200/9100 GTX1050 delivers up to 28% system performance improved than the one without an independent CUDA graphics engine; Advanced Intel® HD Graphics 630/530 and independent NVIDIA GeForce® GTX 1050 graphics engine supporting DirectX 12.1, OpenGL 4.5 and OpenCL 2.0 API, featuring multiple VGA, DVI-D, DVI-I, DisplayPort and HDMI display interfaces, up to 8K resolution and 6 independent HD displays, Vecow ECS-9200/9100 GTX1050 offers more than 400% improved graphics performance than the one without an independent graphics engine; Multiple SATA III (6Gbps), USB 3.0 (5Gbps), PoE (1Gbps) LAN and WiFi/4G/3G/LTE/GPRS/UMTS wireless connections make high-speed data conveying possible. Vecow ECS-9200/9100 GTX1050 Series GPU Computing System brings you new generation workstation-grade system performance with enhanced power productivity for demanding workloads in real-time embedded applications.

All-in-one integrated features, -20°C to 60°C operating temperature, 6 GigE LAN ports with 4 IEEE 802.3at (25.5W/48V) PoE+ without additional power connections, 3 external SIM sockets for WiFi/3G/4G/LTE/GPRS/UMTS, 2 Front-access 2.5" SSD trays, 1 Front-access CFast socket, 2 SATA III supports software RAID function, 8 external USB 3.0, 4 COM RS-232/422/485, M.2 expansion, M2DOM expansion, 3 Mini PCIe/mSATA sockets, 32 Isolated DIO for smart circuit protection, 10V to 36V wide range power input with 80V Surge protection, configurable ignition power control, smart remote management features, remote power switch, EN50155 and EN50121 compliant, Vecow ECS-9200/9100 GTX1050 Series GPU Computing System features multiple I/O, all-in-one integrated functions and industrial-grade reliability for any performance-driven real-time applications.

With workstation-grade system performance, leading integrated features, smart manageability, outstanding mobile availability, secure power protection and rugged reliability, Vecow ECS-9200/9100 GTX1050 Series GPU Computing System is your great choices for Machine Vision, Embedded Workstation, Vehicle Computing, Mobile DVR/NVR, Deep Learning, Artificial Intelligence and any Industry 4.0/IIoT graphics performance-driven real-time embedded computing applications.



## 1.2 Features

- LGA 1151 Socket supports workstation-grade Intel® Xeon®/Core™ i7 Processor (Kaby Lake/Skylake) with C236 chipset
- NVIDIA GeForce® GTX 1050 Graphics engine supports NVIDIA Pascal™ GPU architecture, up to 8K resolution
- Multiple DVI-D, DVI-I, DisplayPort and HDMI display interfaces, up to 6 independent HD displays
- 2 DDR4 2133MHz Memory, up to 32GB (ECC/Non-ECC)
- 6 Independent GigE LAN with 4 IEEE 802.3at PoE+, iAMT 11.0 supported
- 3 SIM Card Socket for 3G/4G/LTE/WiFi/GPRS/UMTS
- Storage : 2 2.5" SSD Tray, 1 CFast, 1 M2DOM, 2 SATA III
- Expansion : 1 M.2 Socket, 3 Mini PCIe/mSATA
- 8 External USB 3.0, 4 COM
- 32 Isolated DIO, 3 Mini PCIe/mSATA
- 10V to 36V DC power input with 80V Surge Protection
- Configurable Ignition Power Control
- -20°C to 60°C Operating Temperature

## 1.3 Product Specification

### 1.3.1 Specifications of ECS-9240 GTX1050

System	
Processor	Quad Core 7th/6th Generation Intel® Xeon®/Core™ i7 Processor (Kaby Lake-S/Skylake-S)
Chipset	Intel® C236
BIOS	AMI
SIO	IT8786E
Memory	<ul style="list-style-type: none"><li>• DDR4 2133MHz</li><li>• Up to 32GB</li><li>• 2 260-pin SO-DIMM Socket (ECC/Non-ECC)</li></ul>
I/O Interface	
Serial	4 COM RS-232/422/485 w/auto flow control (ESD 8KV)
USB	<ul style="list-style-type: none"><li>• 8 USB 3.0 (External)</li><li>• 1 USB 2.0 (Internal)</li></ul>
Isolated DIO	32 Isolated DIO (16 DI, 16 DO)
LED	Power, HDD, Wireless, PoE
SIM Card	3 External SIM Card Socket

<b>Expansion</b>	
Mini PCIe	3 Full-size for PCIe/USB/External SIM Card/mSATA
M.2	1 M.2 Socket (Key ID : M)
<b>Graphics</b>	
Processor	<ul style="list-style-type: none"> <li>• Intel® HD Graphics 630/530</li> <li>• NVIDIA® GeForce® GTX 1050 Ti/GTX 1050</li> </ul>
Interface	6 Display interfaces : <ul style="list-style-type: none"> <li>• 3 DVI : Up to 1920 x1200 @ 60 Hz</li> <li>• 1 DisplayPort : Up to 7680 x 3840 @ 60Hz</li> <li>• 1 DisplayPort : Up to 4096 x 2304 @ 60Hz</li> <li>• 1 HDMI : Up to 4096 × 2160 @ 60Hz</li> </ul>
<b>Storage</b>	
SATA	2 SATA III support software RAID 0, 1
mSATA	3 SATA III (Mini PCIe Type, 6Gbps)
M2DOM	1 PCIe 3.0 (8GT/s)
Storage Device	<ul style="list-style-type: none"> <li>• 1 CFast Socket, Push-in/Push-out Ejector</li> <li>• 2 Front-access 2.5" SSD/HDD Tray</li> </ul>
<b>Audio</b>	
Audio Codec	Realtek ALC892, 5.1 Channel HD Audio
Audio Interface	1 Mic-in, 1 Line-out
<b>Ethernet</b>	
LAN 1	Intel® I219 GigE LAN supports iAMT 11.0
LAN 2	Intel® I210 GigE LAN
<b>PoE (ECS-9200)</b>	
LAN 3	GigE IEEE 802.3at (25.5W/48V) PoE <sup>+</sup> by Intel® I210
LAN 4	GigE IEEE 802.3at (25.5W/48V) PoE <sup>+</sup> by Intel® I210
LAN 5	GigE IEEE 802.3at (25.5W/48V) PoE <sup>+</sup> by Intel® I210
LAN 6	GigE IEEE 802.3at (25.5W/48V) PoE <sup>+</sup> by Intel® I210
<b>Power</b>	
Input Voltage	10V to 36V, DC-in
Power Interface	3-pin Terminal Block : V+, V-, Frame Ground
Ignition Control	16 Mode (Internal)
Remote Switch	3-pin Terminal Block : On, Off, IGN
Surge Protection	Up to 80V/1ms Transient Power

<b>Others</b>	
TPM	Optional Infineon SLB9665 supports TPM 2.0, LPC interface
Watchdog Timer	Reset : 1 to 255 sec./min. per step
Smart Management	Wake on LAN, PXE supported
HW Monitor	Monitoring temperature, voltages. Auto throttling control when CPU overheats.
<b>Software Support</b>	
OS	Windows 10, Windows 8.1, Windows 7, Linux
<b>Mechanical</b>	
Dimensions (WxDxH)	260mm x 215mm x 79mm (10.2" x 8.5" x 3.1")
Weight	4.3 kg (9.48 lb)
Mounting	<ul style="list-style-type: none"> <li>• Wallmount by mounting bracket</li> <li>• DIN Rail Mount (Optional)</li> <li>• 2U Rackmount (Optional)</li> </ul>
<b>Environment</b>	
Operating Temperature	<b>35W TDP CPU :</b> Xeon® E3-1268L v5, Core™ i7 : -20°C to 60°C (-4°F to 140°F) <b>65W TDP CPU :</b> Core™ i7 : -20°C to 55°C (-4°F to 131°F) <b>80W TDP CPU :</b> Xeon® E3-1275 v6, E3-1275 v5, E3-1225 v5 : -20°C to 45°C (-4°F to 113°F)
Storage Temperature	-40°C to 85°C (-40°F to 185°F)
Humidity	5% to 95% Humidity, non-condensing
Relative Humidity	95% at 60°C
Shock	<ul style="list-style-type: none"> <li>• IEC 60068-2-27</li> <li>• SSD : 50G @ Wallmount, Half-sine, 11ms</li> </ul>
Vibration	<ul style="list-style-type: none"> <li>• IEC 60068-2-64</li> <li>• SSD : 5Grms, 5Hz to 500Hz, 3 Axis</li> </ul>
EMC	CE, FCC, EN50155, EN50121-3-2

### 1.3.2 Specifications of ECS-9100 GTX1050

<b>System</b>	
Processor	Quad Core 7th/6th Generation Intel® Xeon®/Core™ i7 Processor (Kaby Lake-S/Skylake-S)
Chipset	Intel® C236
BIOS	AMI
SIO	IT8786E
Memory	<ul style="list-style-type: none"> <li>• DDR4 2133MHz</li> <li>• Up to 32GB</li> <li>• 2 260-pin SO-DIMM Socket (ECC/Non-ECC)</li> </ul>
<b>I/O Interface</b>	
Serial	4 COM RS-232/422/485 w/auto flow control (ESD 8KV)
USB	<ul style="list-style-type: none"> <li>• 8 USB 3.0 (External)</li> <li>• 1 USB 2.0 (Internal)</li> </ul>
DIO	16 GPIO
LED	Power, HDD, Wireless
SIM Card	3 External SIM Card Socket
<b>Expansion</b>	
Mini PCIe	3 Full-size for PCIe/USB/External SIM Card/mSATA
M.2	1 M.2 Socket (Key ID : M)
<b>Graphics</b>	
Processor	<ul style="list-style-type: none"> <li>• Intel® HD Graphics 630/530</li> <li>• NVIDIA® GeForce® GTX 1050 Ti/GTX 1050</li> </ul>
Interface	6 Display interfaces : <ul style="list-style-type: none"> <li>• 3 DVI : Up to 1920 x1200 @ 60 Hz</li> <li>• 1 DisplayPort : Up to 7680 x 3840 @ 60Hz</li> <li>• 1 DisplayPort : Up to 4096 x 2304 @ 60Hz</li> <li>• 1 HDMI : Up to 4096 × 2160 @ 60Hz</li> </ul>
<b>Storage</b>	
SATA	2 SATA III support software RAID 0, 1
mSATA	3 SATA III (Mini PCIe Type, 6Gbps)
M2DOM	1 PCIe 3.0 (8GT/s)
Storage Device	<ul style="list-style-type: none"> <li>• 1 CFast Socket, Push-in/Push-out Ejector</li> <li>• 2 Front-access 2.5" SSD/HDD Tray</li> </ul>
<b>Audio</b>	
Audio Codec	Realtek ALC892, 5.1 Channel HD Audio
Audio Interface	1 Mic-in, 1 Line-out
<b>Ethernet</b>	

LAN 1	Intel® I219 GigE LAN supports iAMT 11.0
LAN 2	Intel® I210 GigE LAN
<b>Power</b>	
Input Voltage	10V to 36V, DC-in
Power Interface	3-pin Terminal Block : V+, V-, Frame Ground
Ignition Control	16 Mode (Internal)
Remote Switch	3-pin Terminal Block : On, Off, IGN
Surge Protection	Up to 80V/1ms Transient Power
<b>Others</b>	
TPM	Optional Infineon SLB9665 supports TPM 2.0, LPC interface
Watchdog Timer	Reset : 1 to 255 sec./min. per step
Smart Management	Wake on LAN, PXE supported
HW Monitor	Monitoring temperature, voltages. Auto throttling control when CPU overheats.
<b>Software Support</b>	
OS	Windows 10, Windows 8.1, Windows 7, Linux
<b>Mechanical</b>	
Dimensions (WxDxH)	260mm x 215mm x 79mm (10.2" x 8.5" x 3.1")
Weight	4.3 kg (9.48 lb)
Mounting	<ul style="list-style-type: none"> <li>• Wallmount by mounting bracket</li> <li>• DIN Rail Mount (Optional)</li> <li>• 2U Rackmount (Optional)</li> </ul>
<b>Environment</b>	
Operating Temperature	<b>35W TDP CPU :</b> Xeon® E3-1268L v5, Core™ i7 : -20°C to 60°C (-4°F to 140°F) <b>65W TDP CPU :</b> Core™ i7 : -20°C to 55°C (-4°F to 131°F) <b>80W TDP CPU :</b> Xeon® E3-1275 v6, E3-1275 v5, E3-1225 v5 : -20°C to 45°C (-4°F to 113°F)
Storage Temperature	-40°C to 85°C (-40°F to 185°F)
Humidity	5% to 95% Humidity, non-condensing
Relative Humidity	95% at 60°C
Shock	<ul style="list-style-type: none"> <li>• IEC 60068-2-27</li> <li>• SSD : 50G @ Wallmount, Half-sine, 11ms</li> </ul>

Vibration	<ul style="list-style-type: none"> <li>• IEC 60068-2-64</li> <li>• SSD : 5Grms, 5Hz to 500Hz, 3 Axis</li> </ul>
EMC	CE, FCC, EN50155, EN50121-3-2

## 1.4 Supported CPU List

Processor No.	TDP	Cache	Max. Frequency	Embedded
Xeon® E3-1575M v5	45W	8M	Up to 3.00 GHz	
Xeon® E3-1545M v5	45W	8M	Up to 2.90 GHz	
Xeon® E3-1535M v5	45W	8M	Up to 2.80 GHz	
Xeon® E3-1515M v5	45W	8M	Up to 2.80 GHz	
Xeon® E3-1505M v5	45W	8M	Up to 2.80 GHz	Yes
Xeon® E3-1505L v5	25W	8M	Up to 2.00 GHz	
Core i7-6970HQ	45W	8M	Up to 3.70 GHz	
Core i7-6920HQ	45W	8M	Up to 3.80 GHz	
Core i7-6870HQ	45W	8M	Up to 3.60 GHz	
Core i7-6820HQ	45W	8M	Up to 3.60 GHz	
Core i7-6770HQ	45W	6M	Up to 3.50 GHz	
Core i7-6700HQ	45W	6M	Up to 3.50 GHz	
Core i7-6820EQ	45W	8M	Up to 3.50 GHz	Yes
Core i7-6822EQ	25W	8M	Up to 2.80 GHz	

# 1.5 Mechanical Dimension

## 1.5.1 Dimensions of ECS-9240 GTX1050

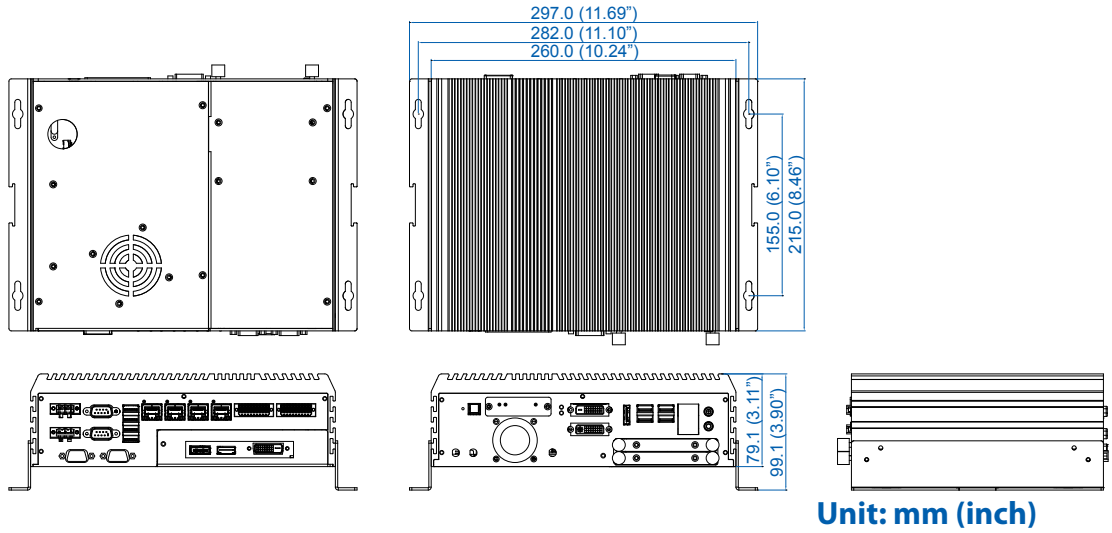

## 1.5.2 Dimensions of ECS-9100 GTX1050

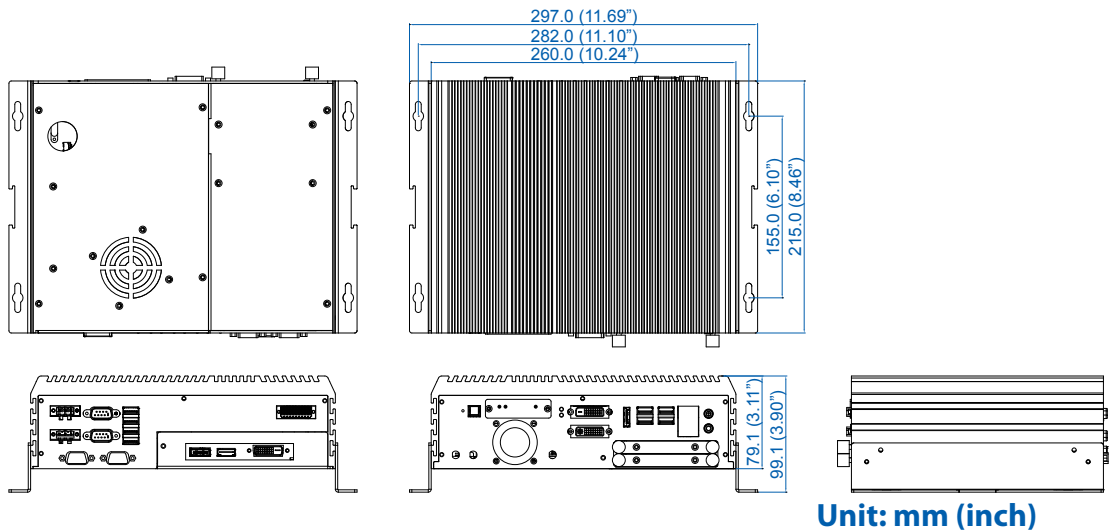

# 2

## GETTING TO KNOW YOUR ECS-9200/9100 GTX1050

### 2.1 Packing List

Item	Description	Qty
1	ECS-9200/9100 GTX1050 Embedded System (According to the configuration you order, ECS-9200/9100 GTX1050 series may contain SSD/HDD and DDR4 SO-DIMM. Please verify these items if necessary.)	1
2	ECS-9240 GTX1050 Accessory box, which contains <ul style="list-style-type: none"><li>• Vecow Drivers &amp; Utilities DVD</li><li>• Wall-mounting bracket</li><li>• KHS#6-32x6 screw for wall-mounting bracket</li><li>• M2.5x6 screw for Mini PCIe Slot</li><li>• Din-Rail-PH-M4x16.5-S Ni</li><li>• 3-pin pluggable terminal block</li><li>• 20-pin pluggable terminal block</li><li>• M3x6 screw for M.2</li><li>• Foot Pad</li><li>• F-M3x4 for SSD/HDD screws</li></ul>	1 2 4 3 4 2 2 1 4 4
3	ECS-9100 GTX1050 Accessory box, which contains <ul style="list-style-type: none"><li>• Vecow Drivers &amp; Utilities DVD</li><li>• Wall-mounting bracket</li><li>• KHS#6-32x6 screw for wall-mounting bracket</li><li>• M2.5x6 screw for Mini PCIe Slot</li><li>• Din-Rail-PH-M4x16.5-S Ni</li><li>• 3-pin pluggable terminal block</li><li>• 20-pin pluggable terminal block</li><li>• M3x6 screw for M.2</li><li>• Foot Pad</li><li>• F-M3x4 for SSD/HDD screws</li></ul>	1 2 4 3 4 2 1 1 4 4



## 2.2 Front Panel I/O & Functions

In Vecow ECS-9200/9100 GTX1050 series family, all I/O connectors are located on the front panel and the rear panel. Most of the general connections to computer device, such as USB, LAN Jack, Audio, Display Port, DVI-I, DVI-D and other additional storage, are placed on the front panel.

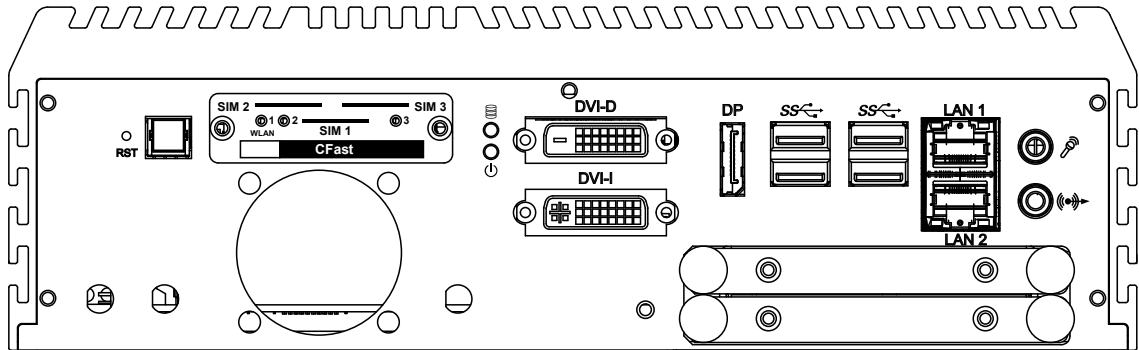

### 2.2.1 Power Button

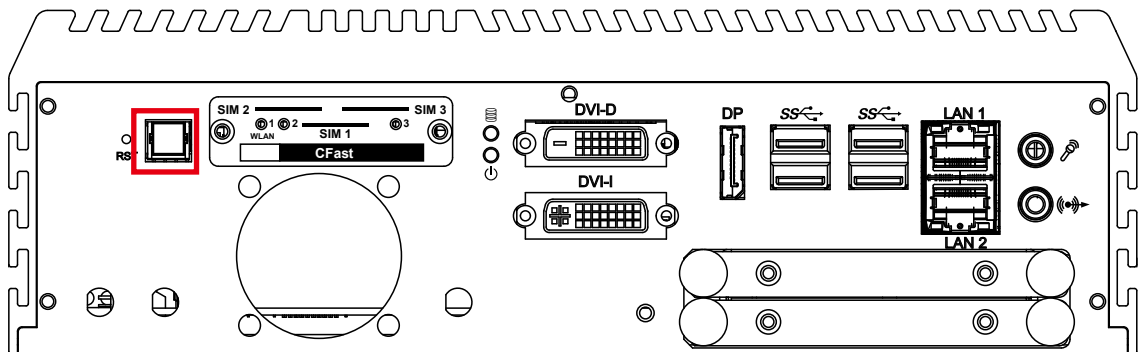

The Power Button is a non-latched switch with dual color LED indications. It indicates power status: S0, S3 and S5. More detail LED indications are listed as follows:

LED Color	Power Status	System Status
Solid Blue	S0	System working
Solid Orange	S3, S5	Suspend to RAM, System off with standby power

To power on the system, press the power button and then the blue LED is lightened. To power off the system, you can either command shutdown by OS operation, or just simply press the power button.

If system error, you can just press the power button for 4 seconds to shut down the machine directly. Please do note that a 4-second interval between each 2 power-on/power-off operation is necessary in normal working status. (For example, once turning off the system, you have to wait for 4 seconds to initiate another power-on operation.)

## 2.2.2 Reset Tact Switch

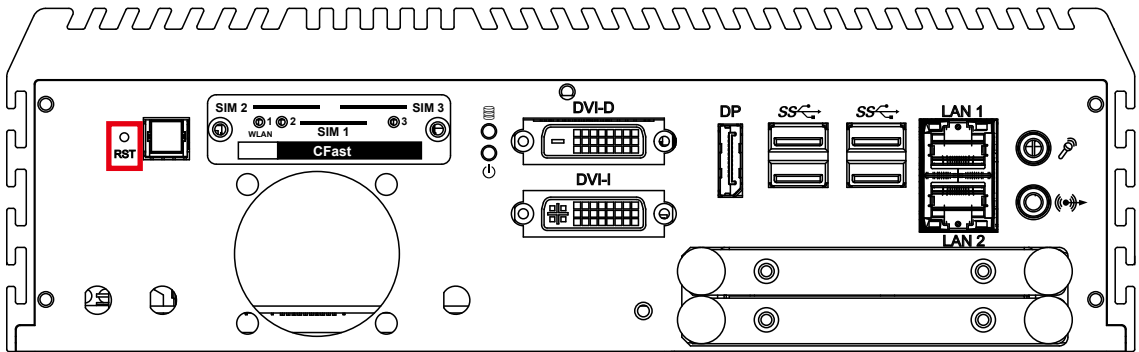

It is a hardware reset switch. Use this switch to reset the system without power off the system. Press the Reset Switch for a few seconds, and then reset will be enabled.

## 2.2.3 CFast Card

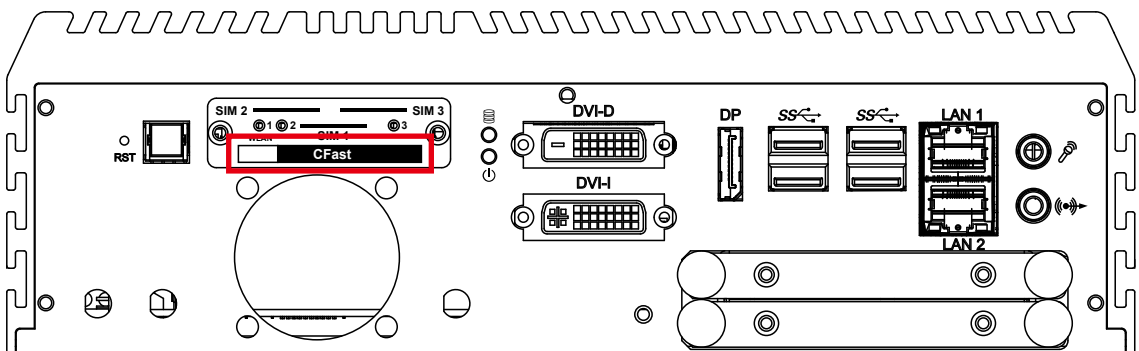

There is a CFast socket on the front panel supporting Type-I/II Compact Flash card. It is implemented by a SATA III Port from C236 PCH. Be sure to disconnect the power source and unscrew the CFast socket cover before installing a CFast card. ECS-9200/9100 GTX1050 does not support the CFast hot swap and PnP (Plug and Play) functions. It is necessary to remove power source first before inserting or removing the CFast card.

The pinouts of CFast port are listed as follows:

Pin No.	Description	Pin No.	Description
S1	GND	PC6	NC
S2	SATA_TXP4	PC7	GND
S3	SATA_TXN4	PC8	CFAST_LED
S4	GND	PC9	NC
S5	SATA_RXN4	PC10	NC
S6	SATA_RXP4	PC11	NC
S7	GND	PC12	NC

Pin No.	Description	Pin No.	Description
PC1	GND	PC13	+3.3V
PC2	GND	PC14	+3.3V
PC3	NC	PC15	GND
PC4	NC	PC16	GND
PC5	NC	PC17	NC

## 2.2.4 PWR and HDD LED Indicator

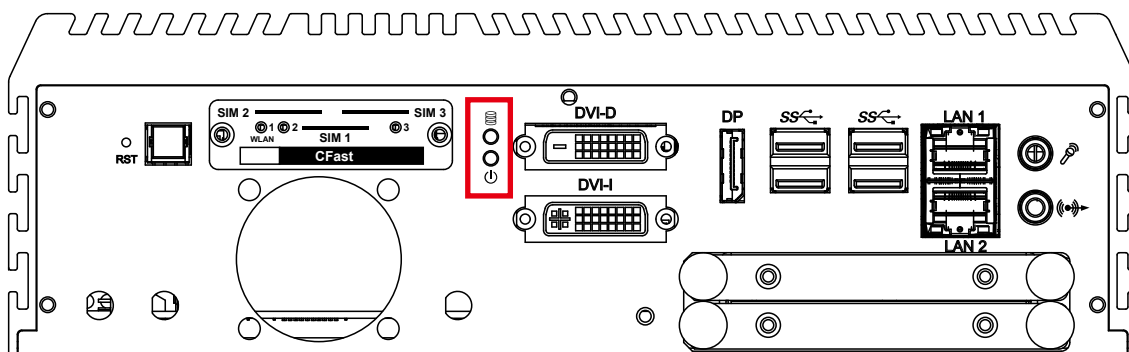

**HDD LED/Yellow :** A Hard Disk/ CFAST LED. If the LED is on, it indicates that the system's storage is functional. If it is off, it indicates that the system's storage is not functional. If it is flashing, it indicates data access activities.

**Power LED/Green :** If the LED is solid green, it indicates that the system is powered on.

LED Color	Power Status	System Status
Yellow	HDD/CFast	<ul style="list-style-type: none"> <li>• On/Off : Storage status, function or not.</li> <li>• Twinkling : Data transferring.</li> </ul>
Green	Power	System power status (on/off)

## 2.2.5 DVI-D Connector

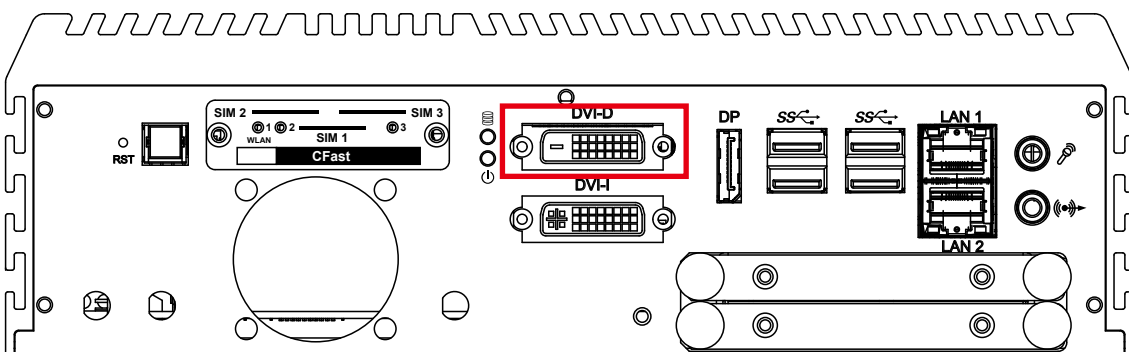

The DVI-D connector on the front panel supports DVI display. This connector can output DVI signal. The DVI output mode supports up to 1920 x 1200 resolution and the DVI is automatically selected according to the display device connected. You will need a DVI-D cable when connecting to a display device.

## 2.2.6 DVI-I Connector

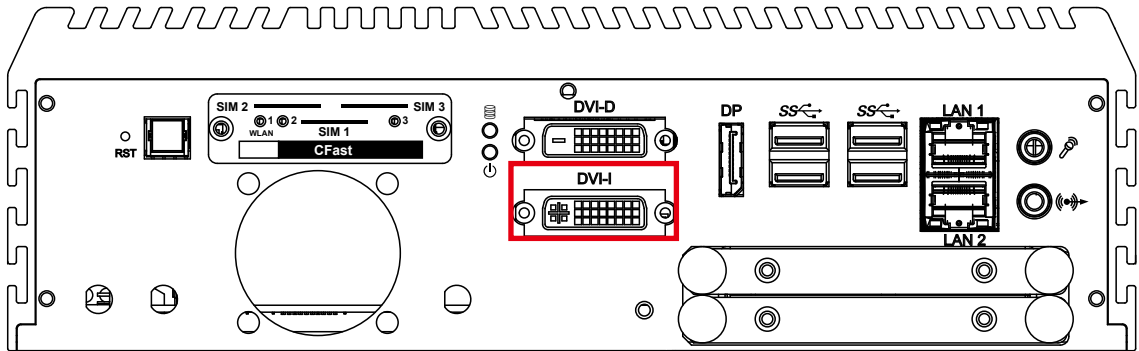

The DVI-I connector on the front panel supports both DVI and VGA display modes. This connector can output DVI signals. The DVI output mode supports up to 1920x1200 resolution. The DVI mode is automatically selected according to the connected display and you will need a DVI-I cable when connecting to a display device. The VGA output mode supports up to 1920x1200 resolution. If using VGA function, you will need a DVI-I to VGA module connected to DVI-I device. Below is the DVI-I to VGA dongle image:



## 2.2.7 DisplayPort

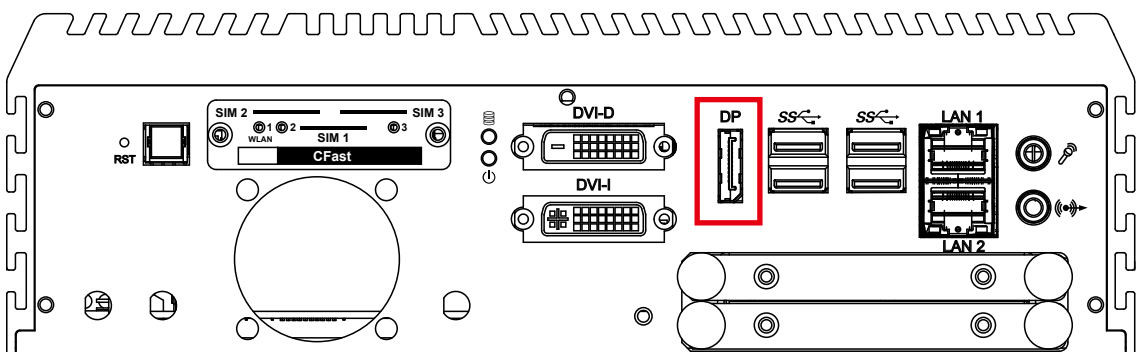

Onboard Display Port supports auxiliary channel dual mode and the connection supports up to 4096 x 2304 resolution at 60 Hz.

Multi-Stream Transport Display Resolutions Table as follows:

Multi-Stream Transport Display	Max. Resolution
One panel Display	4096x2304@60Hz
Two panel Displays concurrently	2880x1800@60Hz
Three panel Displays concurrently	2304x1440@60Hz

## 2.2.8 USB 3.0

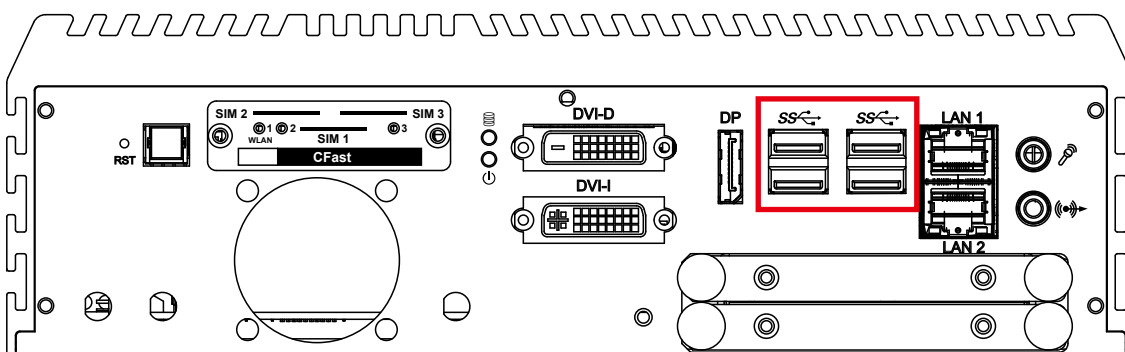

There are 4 USB 3.0 connections available supporting up to 5GB per second data rate in the front side of ECS-9200/9100 GTX1050. It is also compliant with the requirements of Super Speed (SS), High Speed (HS), Full Speed (FS) and Low Speed (LS).

## 2.2.9 Ethernet Port

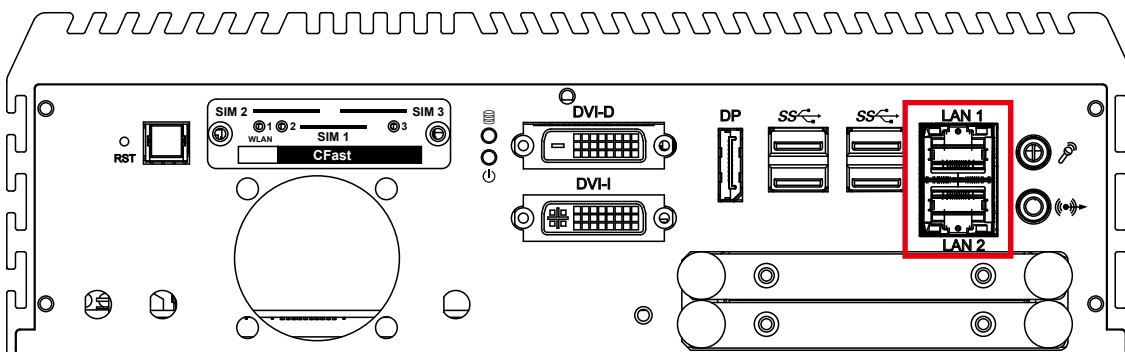

There are dual 8-pin RJ-45 jacks supporting 10/100/1000 Mbps Ethernet connections in the front side. LAN 1 is powered by Intel I219 Ethernet Phy and LAN 2 is powered by Intel I210 Ethernet engine. When both LAN 1 and LAN 2 work in normal status, iAMT 11.0 function is enabled. When using suitable RJ-45 cable, you can connect the system to other computers or to any other devices with Ethernet connection; for example, a hub or a switch. Moreover, both of LAN 1 and LAN 2 support Wake on LAN and Pre-boot functions. The pin-outs of LAN 1 and LAN 2 are listed as follows:

Pin No.	10/ 100Mbps	1000Mbps	Pin No.	10/ 100Mbps	1000Mbps
1	E_TX+	MDI0_P	5	----	MDI2_N
2	E_TX-	MDI0_N	6	E_RX-	MDI1_N
3	E_RX+	MDI1_P	7	----	MDI3_P
4	----	MDI2_P	8	-----	MDI3_N

Each LAN port is supported by standard RJ-45 connector with LED indicators to present Active/ Link/ Speed status of the connection.

The LED indicator on the right bottom corner lightens in solid green when the cable is properly connected to a 100 Mbps Ethernet network, and it lightens in solid orange when the cable is properly connected to a 1000Mbps Ethernet network. The left LED will keep twinkling/ off when Ethernet data packets are being transmitted or received.

	10Mbps	100Mbps	1000Mbps
Right Bottom Led	Off	Solid Green	Solid Orange
Left Bottom Led	Flash Yellow	Flash Yellow	Flash Yellow

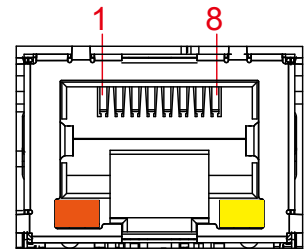

## 2.2.10 Audio Jack

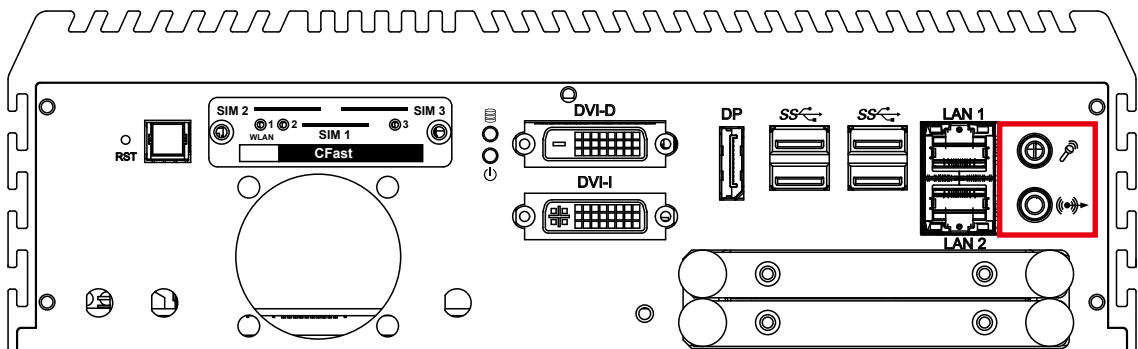

There are 2 audio connectors, Mic-in and Line-out, in the front side of ECS-9200/9100 GTX1050. Onboard Realtek ALC892 audio codec supports 5.1 channel HD audio and fully complies with Intel High Definition Audio (Azalia) specifications. To utilize the audio function in Windows platform, you need to install the corresponding drivers for both Intel C236 chipset and Realtek ALC892 codec.

## 2.2.11 WLAN LED, Mini PCIe, SIM Card Comparison

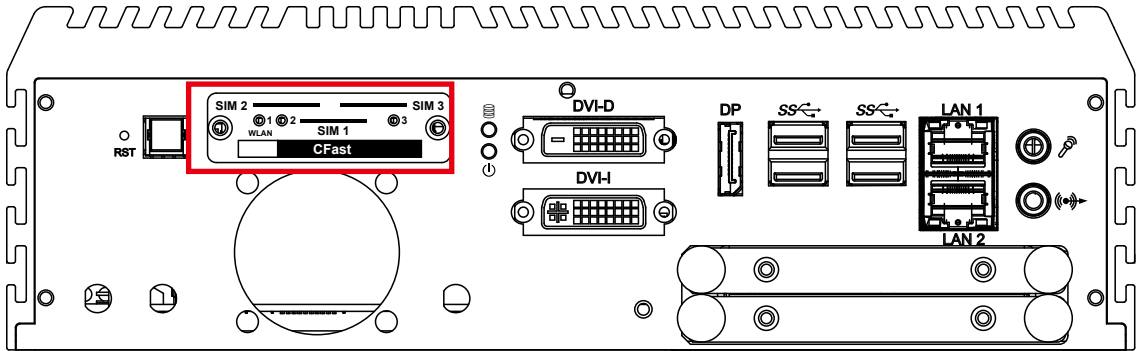

Mini PCIe Slot/SIM Slot/WLAN LED Mapping Table :

Mini PCIe	SIM	LED
Mini PCIe 1	SIM 1 (CN12)	1
Mini PCIe 2	SIM 2 (CN13)	2
Mini PCIe 3	SIM 3 (CN11)	3

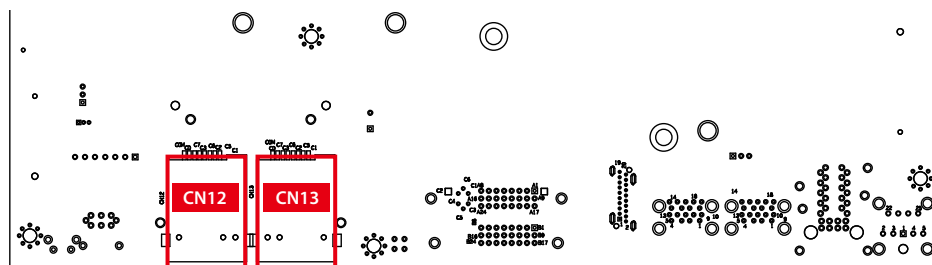
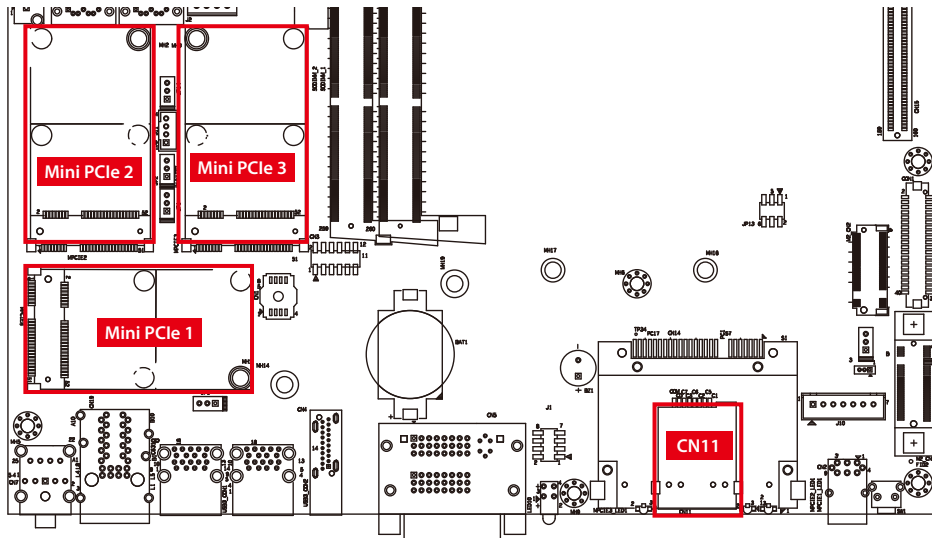

## 2.2.12 SSD/HDD Tray

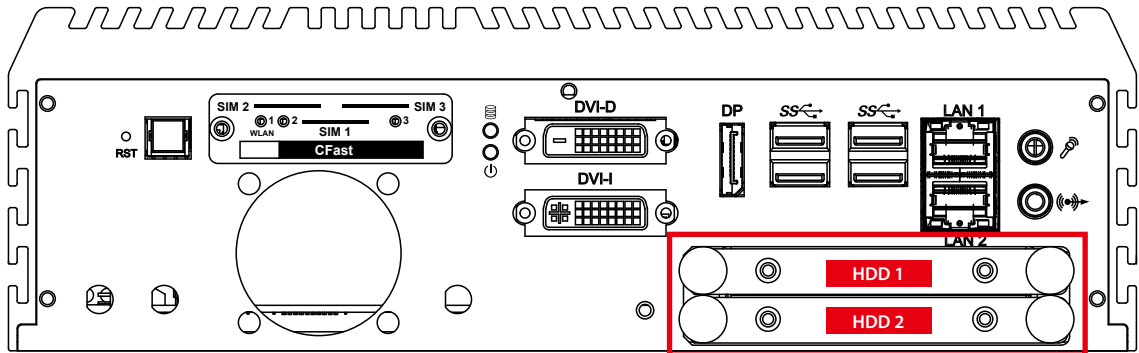

There are 2 front-access 2.5" SSD/HDD trays in the front side of ECS-9200/9100 GTX1050. Just trigger to open the SSD/ HDD tray, up to 4TB is available.

## 2.2.13 System FAN

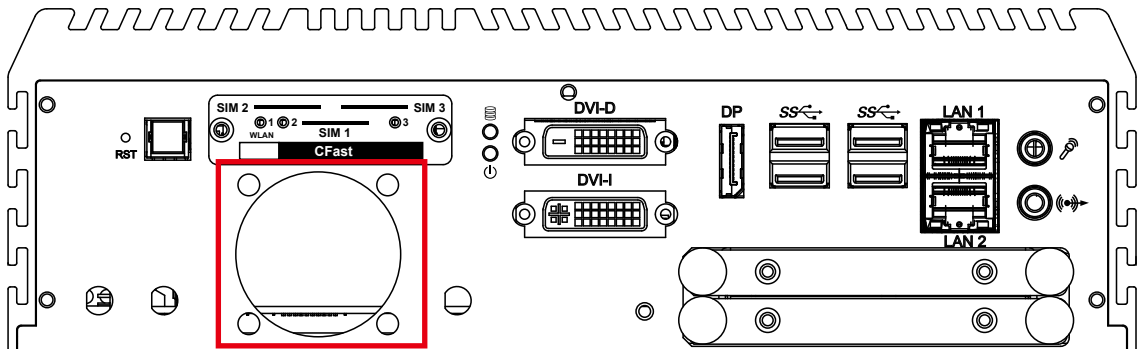

There is a system FAN on front side for airflow direction outward. You can adjust the FAN Speed from Vecow BIOS Setting. (refer to 4.3.6\_Hardware Monitor\_FAN PWM Value)



## 2.3 Rear Panel I/O & Functions

### 2.3.1 Power Terminal Block

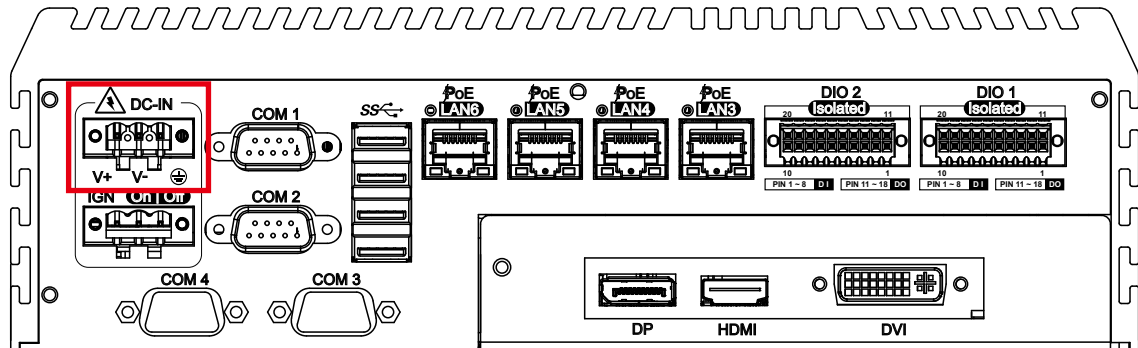

This system supports 6V to 36V DC power input by terminal block in the rear side. In normal power operation, power LED lightens in solid green. It supports up to 80V surge protection.

Pin No.	Definition	Pin No.	Definition
1	V+	2	V-
3	Chassis Ground		

### 2.3.2 Remote Power On/Off Switch & Ignition

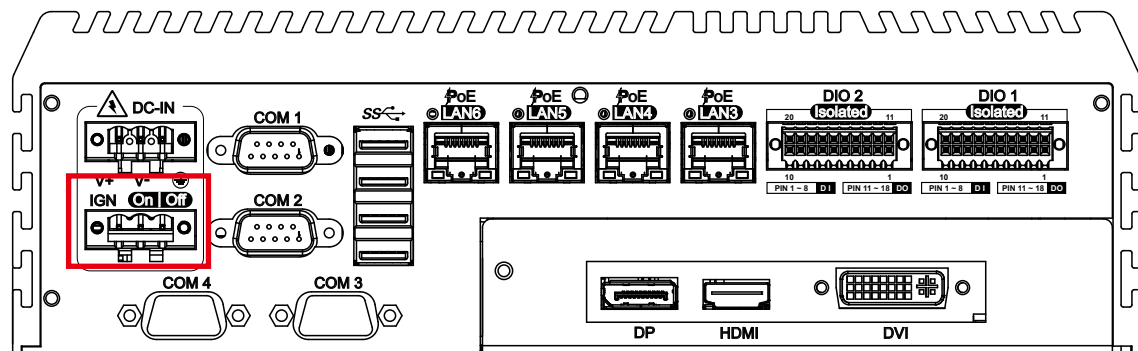

It is a 3-pin power-on or power-off switch through Phoenix Contact terminal block. You could turn on or off the system power by using this contact. This terminal block supports dual functions of soft power-on/power-off (instant off or delay 4 second) and suspend mode.

Pin No.	Definition	Pin No.	Definition
1	Ignition	2	External Power Button V+
3	External Power Button V-		

### 2.3.3 COM Ports

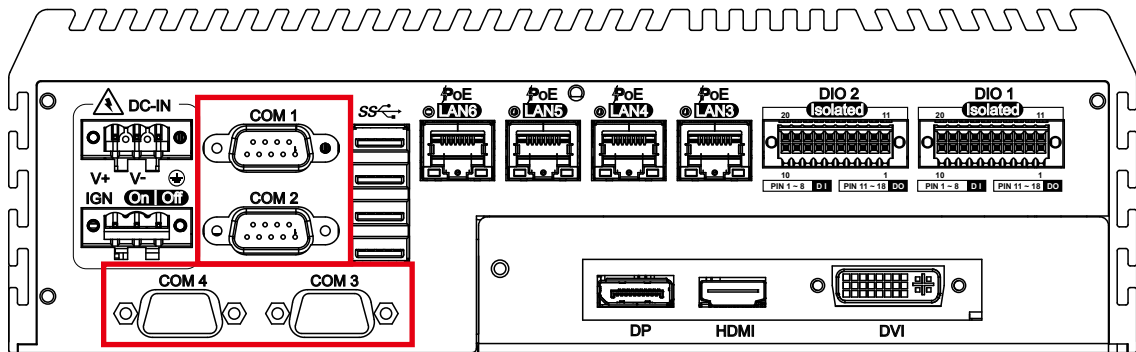

Serial port 1 to 4 (COM 1 to 4) can be configured for RS-232, RS-422, or RS-485 with auto flow control communication. The default definition of COM 1 and COM 2 is RS-232. If you want to change to RS-422 or RS-485, you can find the setting in BIOS.

BIOS Setting	Function
COM 1	RS-232
COM 2	RS-422 (5-wire)
COM 3	RS-422 (9-wire)
COM 4	RS-485
	RS-485 w/z auto-flow control

The pin assignments are listed in the table as below:

Serial Port	Pin No.	RS-232	RS-422 (5-wire)	RS-422 (9-wire)	RS-485 (3-wire)
1 to 4	1	DCD	TXD-	TXD-	DATA-
	2	RXD	TXD+	TXD+	DATA+
	3	TXD	RXD+	RXD+	-----
	4	DTR	RXD-	RXD-	-----
	5	GND	GND	GND	GND
	6	DSR	-----	RTS-	-----
	7	RTS	-----	RTS+	-----
	8	CTS	-----	CTS+	-----
	9	RI	-----	CTS-	-----

COM 3 & COM 4 MB connector table:

COM Port	MB Connector	COM Port	MB Connector
COM 3	CN9	COM 4	CN10

COM 3 & COM 4 MB connector pin out:

CN	Pin No.	Signal Name
CN9 (COM3) CN10 (COM4)	1	Chassis GND
	2	GND
	3	RI
	4	DTR
	5	CTS
	6	TXD
	7	RTS
	8	RXD
	9	DSR
	10	DCD

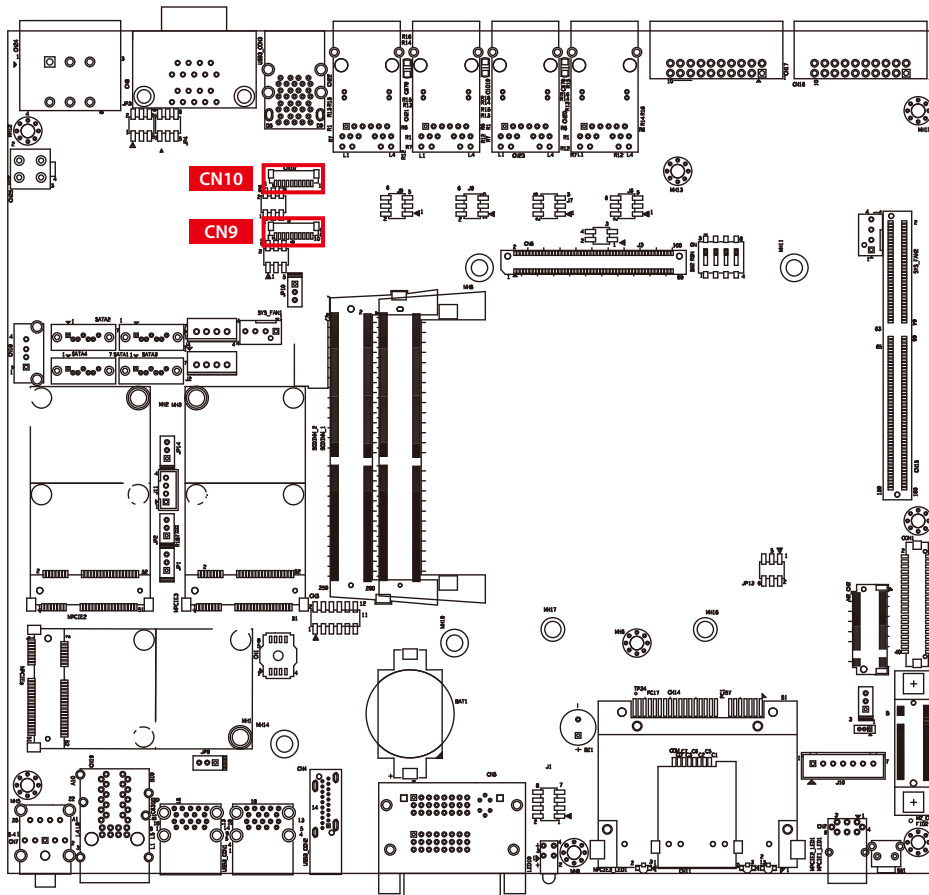

### 2.3.4 Rear USB 3.0

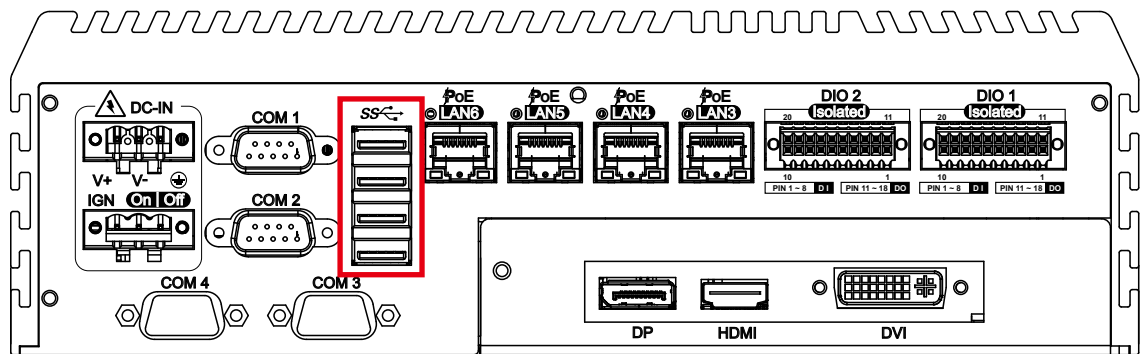

There are 4 USB 3.0 connections available supporting up to 5GB per second data rate in the rear side of ECS-9200/9100 GTX1050. It is also compliant with the requirements of Super Speed (SS), High Speed (HS), Full Speed (FS) and Low Speed (LS).

### 2.3.5 PoE Ethernet Port

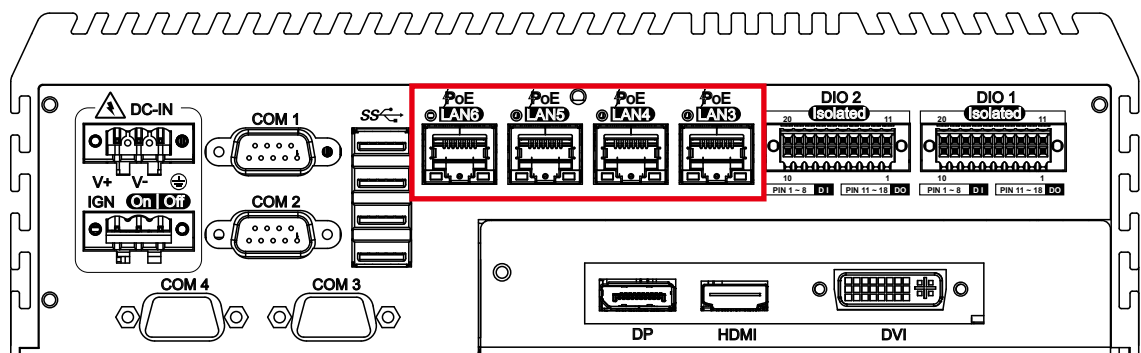

There are 4 RJ45 connectors in the rear side of ECS-9200 GTX1050. It supports IEEE 802.3at (PoE+) Power over Ethernet (PoE) connection delivering up to 30.4W/54V per port and 1000BASE-T GigE data signals over standard Ethernet Cat 5/Cat 6 cable. Each PoE connection is powered by Intel® I210 GigE Ethernet controller and independent PCI express interface to connect with multi-core processor for network and data transmit optimization. Only when PoE port starts to supply power to power devices, the dedicated LED will be lightened.

**PS.** Suggest to use PoE function when power input is over 12V.

The pin-outs of LAN 3 to LAN 6 are listed as follows:

Pin No.	10/ 100 Mbps	1000 Mbps	PoE
1	E_TX+	MDI0_P	PoE+
2	E_TX-	MDI0_N	PoE+
3	E_RX+	MDI1_P	PoE-
4	----	MDI2_P	----
5	-----	MDI2_N	----
6	E_RX-	MDI1_N	PoE-
7	-----	MDI3_P	----
8	-----	MDI3_N	----

Each LAN port is supported by standard RJ-45 connector with LED indicators to present Active/Link/Speed status of the connection & PoE status LED.

The LED indicator on the right bottom corner lightens in solid green when the cable is properly connected to a 100 Mbps Ethernet network. The LED indicator on the right bottom corner lightens in solid orange when the cable is properly connected to a 1000Mbps Ethernet network. The left LED will keep twinkling/off when Ethernet data packets are being transmitted/received.

LED Status	10Mbps	100Mbps	1000Mbps
Right Bottom Led	Off	Solid Green	Solid Orange
Left Bottom Led	Flash Yellow	Flash Yellow	Flash Yellow

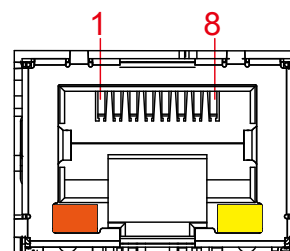

PoE LED indicator:

LED Location	LED Color	Status
LAN3	Green	Green Light: PD installed & powered green Off: Non PD
LAN4	Green	Green Light: PD installed & powered green Off: Non PD
LAN5	Green	Green Light: PD installed & powered green Off: Non PD
LAN6	Green	Green Light: PD installed & powered green Off: Non PD

### 2.3.6 Isolated DIO

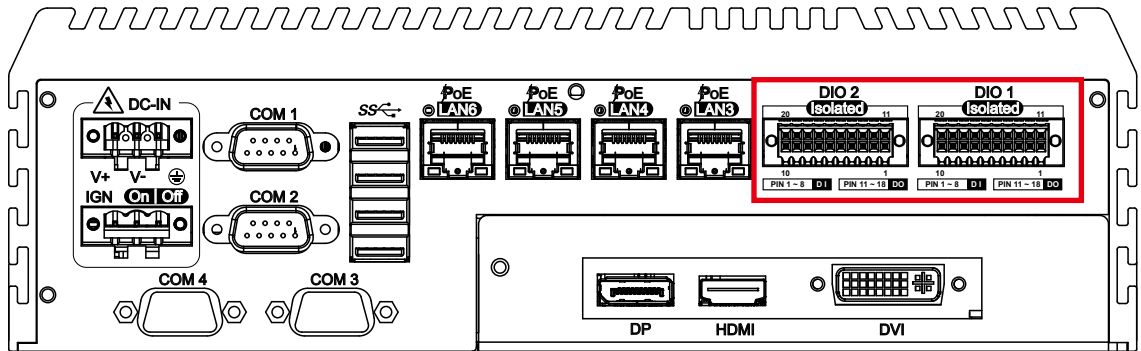

There is a 32-bit (16-bit DI, 16-bit DO) with 2 DIO connectors in the rear side. DI/DIO supports NPN(sink) and PNP(Source) mode, and each DI channel is equipped with a photocoupler for isolated protection. Each DO with isolator chip is configured by a Jumper for each DIO connector.

DO Safety-Related Certifications:

- 4242-VPK Basic Isolation per DIN V VDE V 0884-10 and DIN EN 61010-1
- 3-KVRMS Isolation for 1 minute per UL 1577
- CSA Component Acceptance Notice 5A, IEC 60950-1 and IEC 61010-1 End Equipment Standards
- GB4943.1-2011 CQC Certified

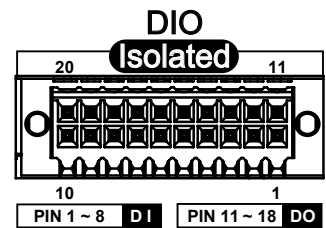

DIO Connectors pin out:

DIO	Pin No.	Definition	Function
DIO1	1	INPUT 0	SIO_GPI80
	2	INPUT 1	SIO_GPI81
	3	INPUT 2	SIO_GPI82
	4	INPUT 3	SIO_GPI83
	5	INPUT 4	SIO_GPI84
	6	INPUT 5	SIO_GPI85
	7	INPUT 6	SIO_GPI86
	8	INPUT 7	SIO_GPI87
	9	DI1_COM	-
	10	DIO1_GND	-
	11	OUTPUT 0	SIO_GPO70
	12	OUTPUT 1	SIO_GPO71
	13	OUTPUT 2	SIO_GPO72
	14	OUTPUT 3	SIO_GPO73
	15	OUTPUT 4	SIO_GPO74
	16	OUTPUT 5	SIO_GPO75
	17	OUTPUT 6	SIO_GPO76
	18	OUTPUT 7	SIO_GPO77
	19	DIO1_GND	-
	20	DIO1_VDC (6~48V Input)	-

DIO	Pin No.	Definition	Function
DIO2	1	INPUT 0	SIO_GPI37
	2	INPUT 1	SIO_GPI56
	3	INPUT 2	SIO_GPI57
	4	INPUT 3	SIO_GPI15
	5	INPUT 4	SIO_GPI16
	6	INPUT 5	SIO_GPI35
	7	INPUT 6	SIO_GPI46
	8	INPUT 7	SIO_GPI11
	9	DI2_COM	-
	10	DIO2_GND	-
	11	OUTPUT 0	SIO_GPO22
	12	OUTPUT 1	SIO_GPO26
	13	OUTPUT 2	SIO_GPO64
	14	OUTPUT 3	SIO_GPO65
	15	OUTPUT 4	SIO_GPO41
	16	OUTPUT 5	SIO_GPO40
	17	OUTPUT 6	SIO_GPO52
	18	OUTPUT 7	SIO_GPO27
	19	DIO2_GND	-
	20	DIO2_VDC (6~48V Input)	-

DI reference circuit:

Sink Mode (NPN)

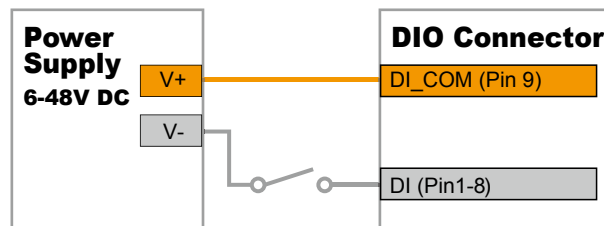

Source Mode (PNP)

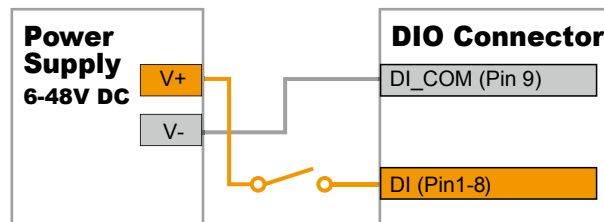

DO reference circuit:

Sink Mode  
(NPN, Default)

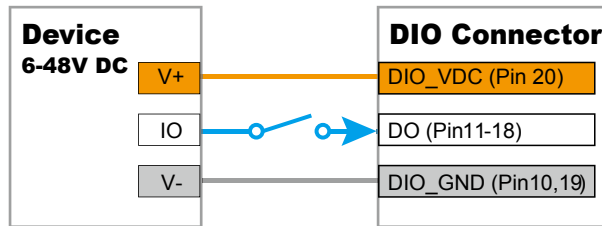

Source Mode  
(PNP)

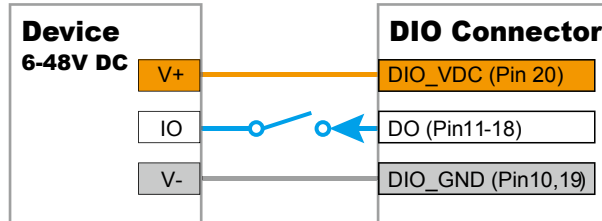

### 2.3.7 3 of 3 Independent Displays

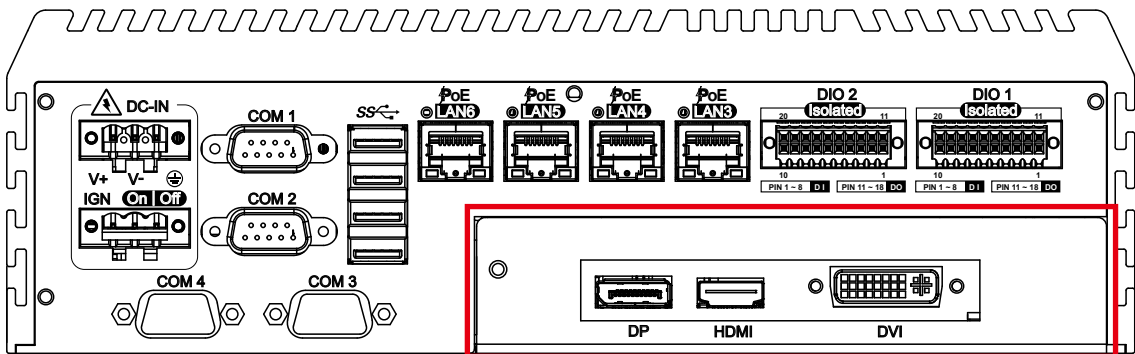

You could have all independent displays from these 3 display ports. Furthermore, you could have an 8K resolution display from the DP1.4 port.



## 2.4 Main Board Expansion Connectors

### 2.4.1 Inside View of ECS-9200/9100 GTX1050 Main Board With Connector Location

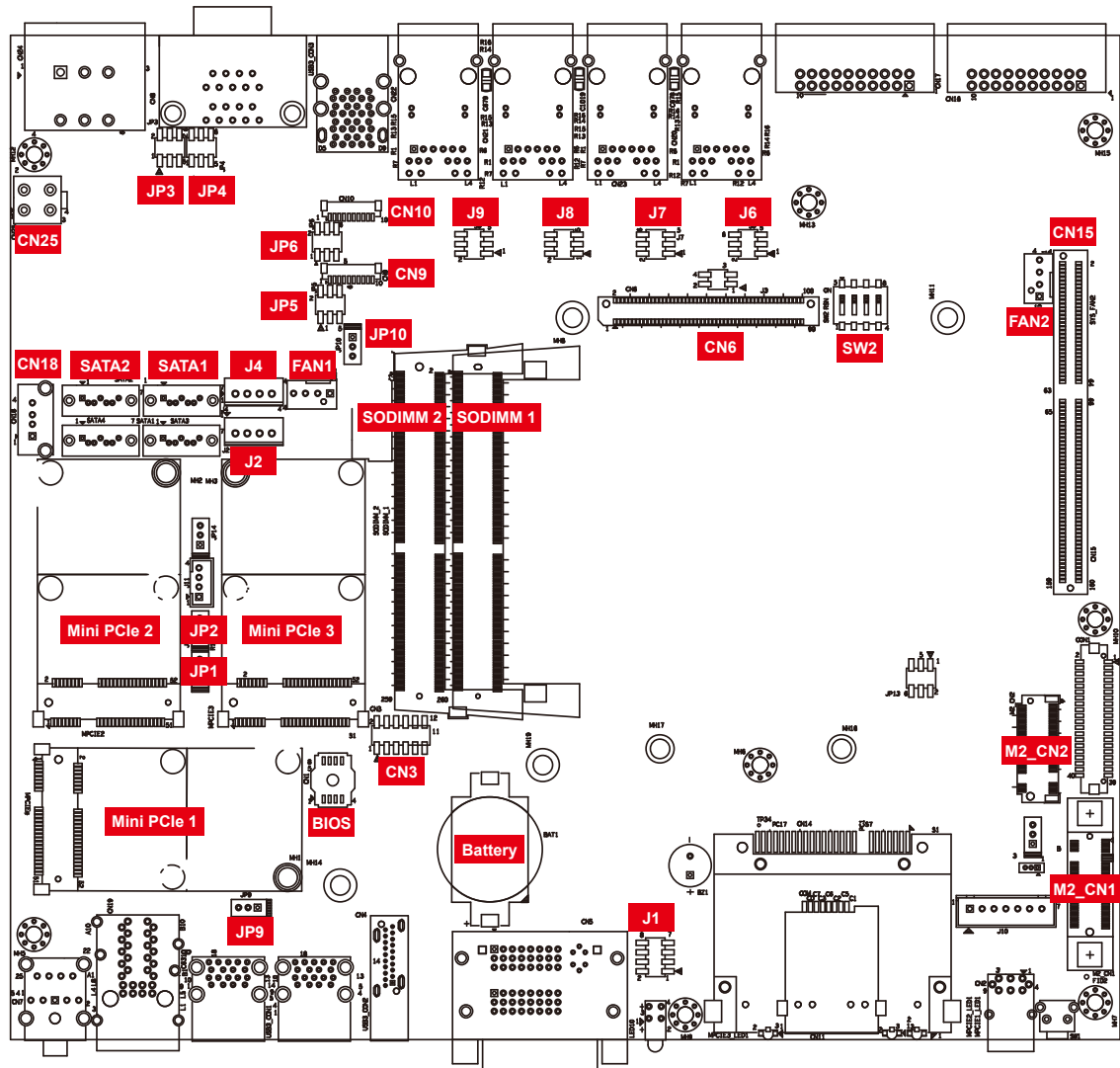

## 2.4.2 UPS Power Connector

For UPS module optional, we use 4.2mm 2x2p power connector.  
This system has a UPS power input connector for Optional part UPS Module.

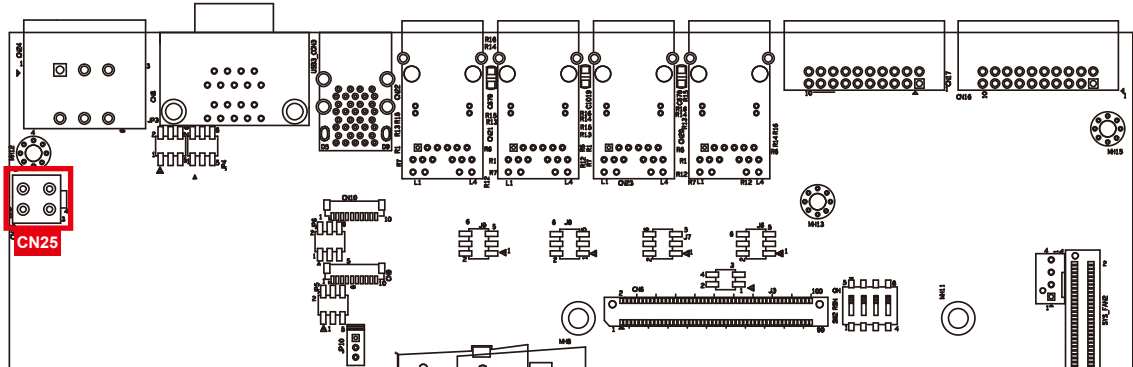

Pin No.	Definition	Pin No.	Definition
1	Ground	2	Ground
3	+VDC_IN (6~36V, Max.8A)	4	+VDC_IN (6~36V, Max.8A)

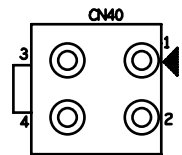

## 2.4.3 Miscellaneous Pin Header

2.0mm 2x4p header

This pin header can be used as a backup for following functions, such as hard drive LED indicator, reset button, power LED indicator, and power-on/ off button, which already can be accessed by front panel and top panel. The pin-outs of Miscellaneous port are listed in following table:

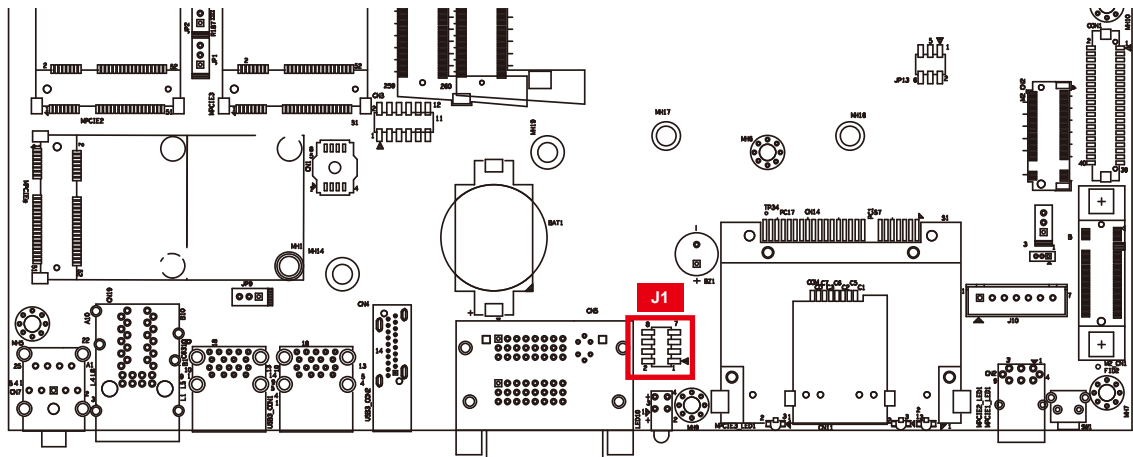

Group	Pin No.	Description
HDD LED	1	HDD_LED_P
	3	HDD_LED_N
RESET BUTTON	5	FP_RST_BTN_N
	7	Ground
POWER LED	2	PWR_LED_P
	4	PWR_LED_N
POWER BUTTON	6	FP_PWR_BTN_IN
	8	Ground

### 2.4.4 DDR4 Slot

There are 2 DDR4 channel onboard supporting DDR4 2133/1866 and up to 32GB. (Each channel 16GB)

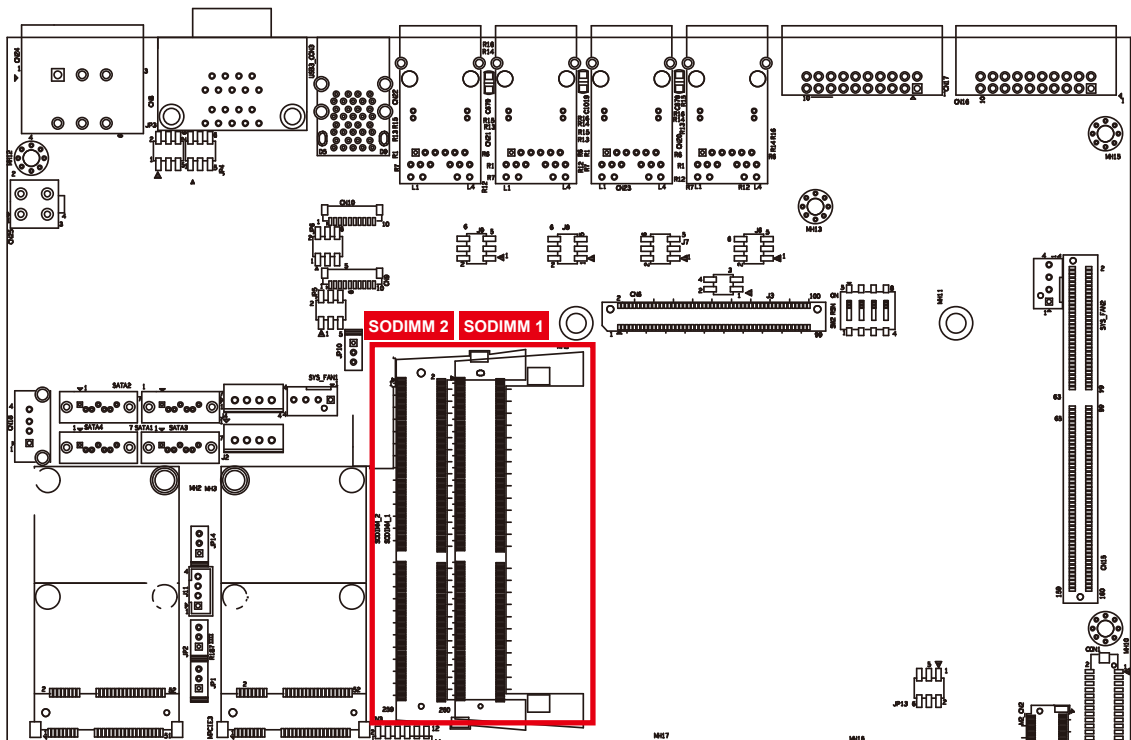

Slot	Description	Slot	Description
SODIMM_1	DDR4 Channel A	SODIMM_2	DDR4 Channel B

## 2.4.5 BIOS Socket

If the BIOS needs to be changed, please contact the Vecow RMA service team.

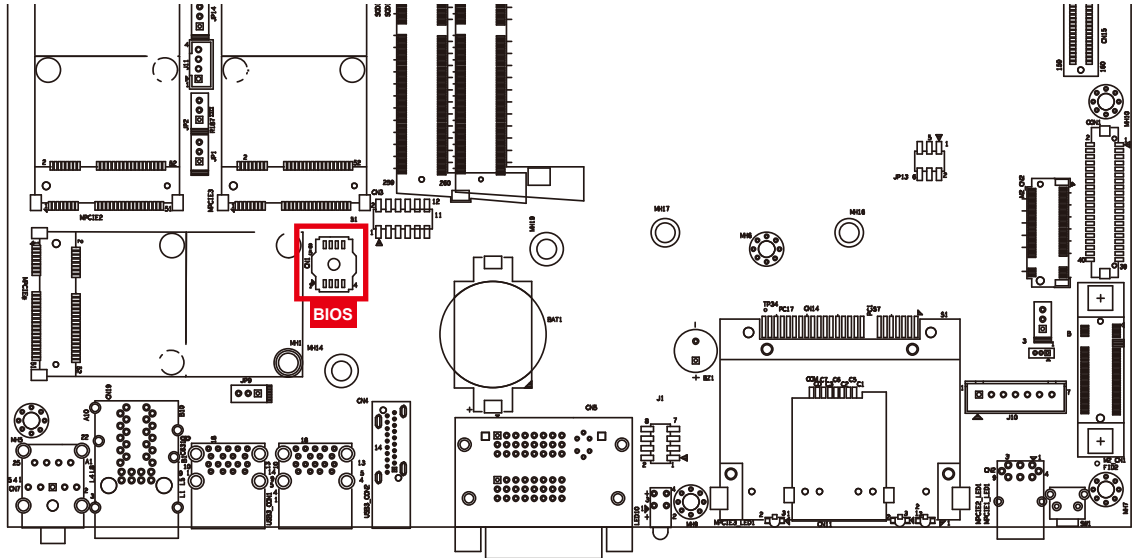

## 2.4.6 SATA Connector

Standard 7 PIN SATA Connector

There are 2 onboard high performance Serial ATA III. It supports higher storage capacity with less cabling effort and smaller required space.

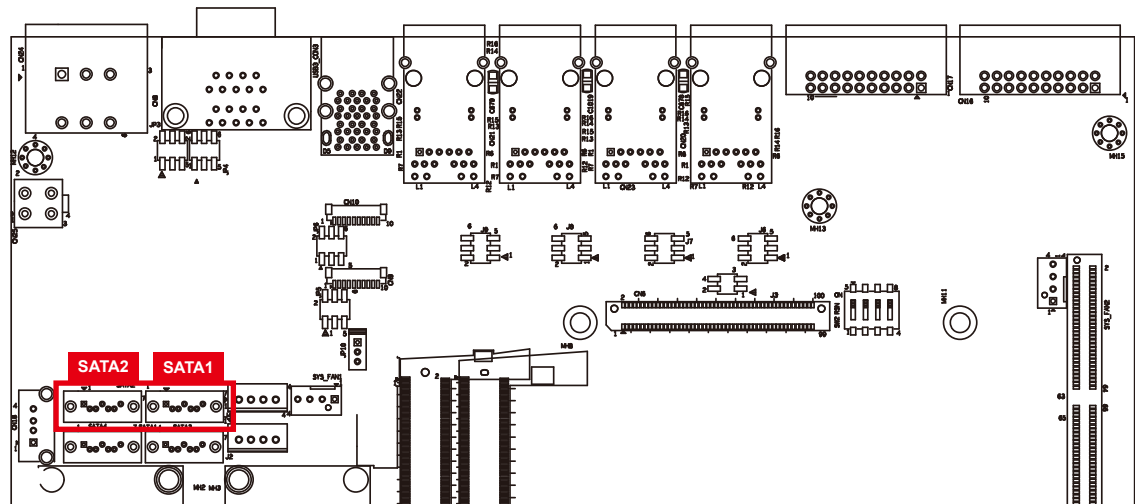

Pin No.	Definition
1	Ground
2	TX DP
3	TX DN
4	Ground

Pin No.	Definition
5	RX DN
6	RX DP
7	Ground

## 2.4.7 SATA Power Header

Standard, all form factor 1x4p power header

There are 2 HDD power header on board and each power header supports two 2.5" SATA HDD.

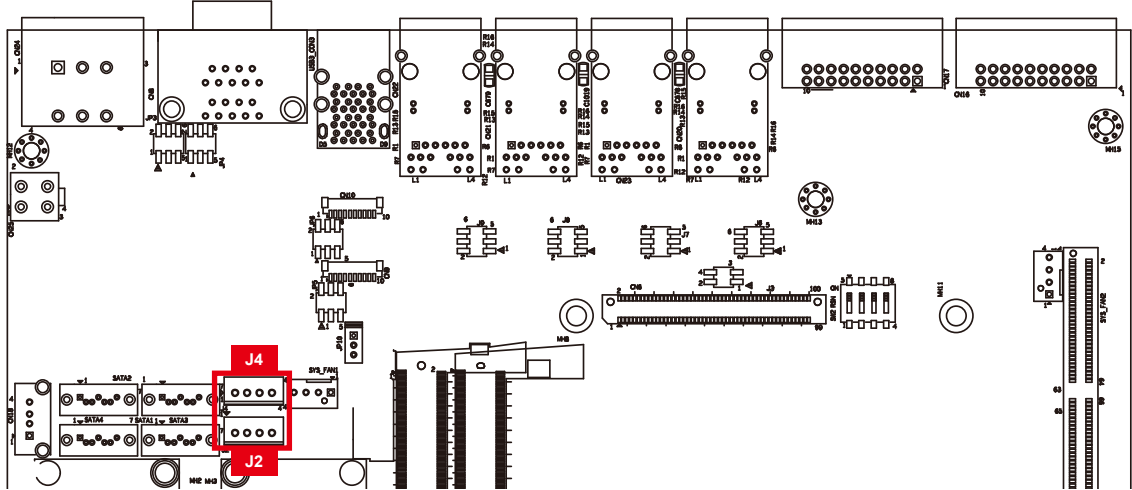

Pin No.	Description	Pin No.	Description
1	+V5 (Max. 4A)	2	Ground
3	Ground	4	+V12 (Max. 1.5A)

## 2.4.8 Internal USB2.0

Standard Vertical USB2.0 Connector

The ECS-9200/9100 GTX1050 main board provides one expansion USB port using plug-and-play for Dongle Key or LCD touch Panel. The USB interface supports 480 Mbps transfer rate complied with high speed USB specification Rev. 2.0.

The USB interface is accessed through one standard USB 2.0 connector. This USB 2.0 does not support wake up function.

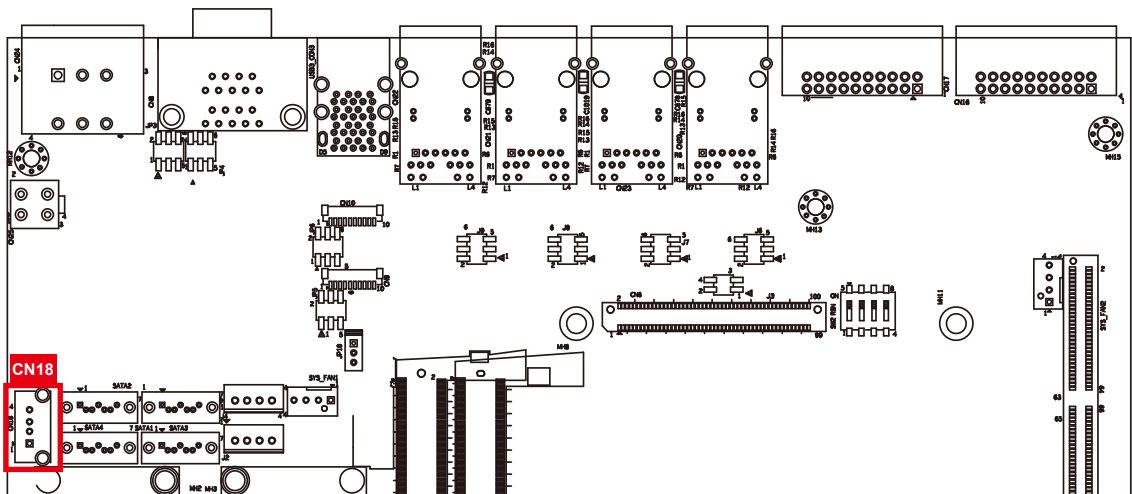

Pin No.	Definition	Pin No.	Definition
1	USB +VCC (+V5/Max. 0.5A)	2	DATA-
3	DATA+	4	Ground

## 2.4.9 M2DOM

Innodisk M2DOM S20/S30 3ME3 is a M.2 based disk module with vertical type form factor. Its mechanical design can help board maker to release up to 90% space of motherboard as well as improve system reliability by its fixed mechanism. M2DOM series product will offer with multiple interfaces, including both SATA III and PCIe. The SSD supports hot plug function and can be removed or plugged-in during operating. User has to avoid hot plugging the SSD which is configured as boot device and installed operation system.

Support hot plug: The insertion of a SATA device into a backplane (signal and power combined) that has power present. The device powers up and initiates an OOB sequence.

Support hot removal: The removal of a SATA device from a powered backplane, without first being placed in a quiescent state.

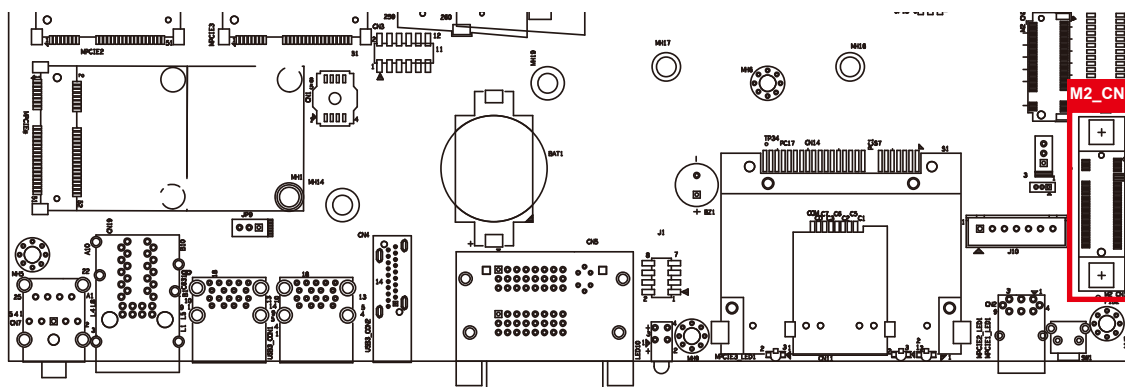

Model No.		Definition
M2DOM	S20	8GB
	S20 / S30	16GB
	S20 / S30	32GB
	S20 / S30	64GB
	S30	128GB



## 2.4.10 M.2

Standard Type 2280 M.2 (M key) slot:

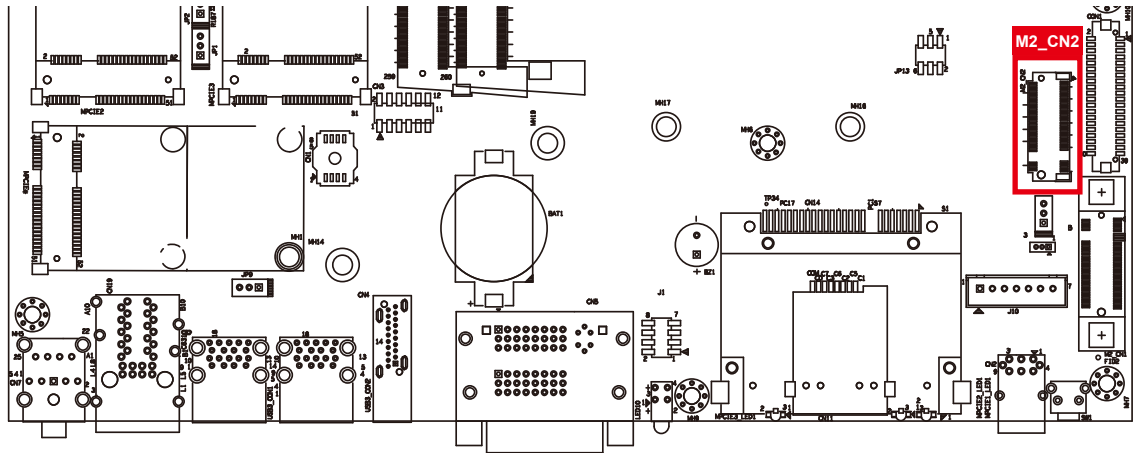

Pin Out:

Pin No.	Function	Pin No.	Function
75	GND		
73	GND	74	+3.3V
71	GND	72	+3.3V
69	PEDET (NC-PCIe/GND-SATA)	70	+3.3V
67	N/C	68	N/C
Mechanical Key			
57	GND	58	N/C
55	REFCLKp	56	N/C
53	REFCLKn	54	WAKE#
51	GND	52	CLKREQ#
49	PETp0 /SATA-A+	50	PERST#
47	PETn0 /SATA-A-	48	N/C
45	GND	46	N/C
43	PERp0 /SATA-B-	44	N/C
41	PERn0 /SATA-B+	42	N/C
39	GND	40	N/C
37	PETp1	38	DEVSLP
35	PETn1	36	N/C
33	GND	34	N/C

31	PERp1	32	N/C
29	PERn1	30	N/C
27	GND	28	N/C
25	PETp2	26	N/C
23	PETn2	24	N/C
21	GND	22	N/C
19	PERp2	20	N/C
17	PERn2	18	+3.3V
15	GND	16	+3.3V
13	PETp3	14	+3.3V
11	PETn3	12	+3.3V
9	GND	10	DAS/DSS# (I/O)/LED1# (I)(0/3.3V)
7	PERp3	8	N/C
5	PERn3	6	N/C
3	GND	4	+3.3V
1	GND	2	+3.3V

## 2.4.11 Mini PCIe

Standard full length Mini PCIe slot:

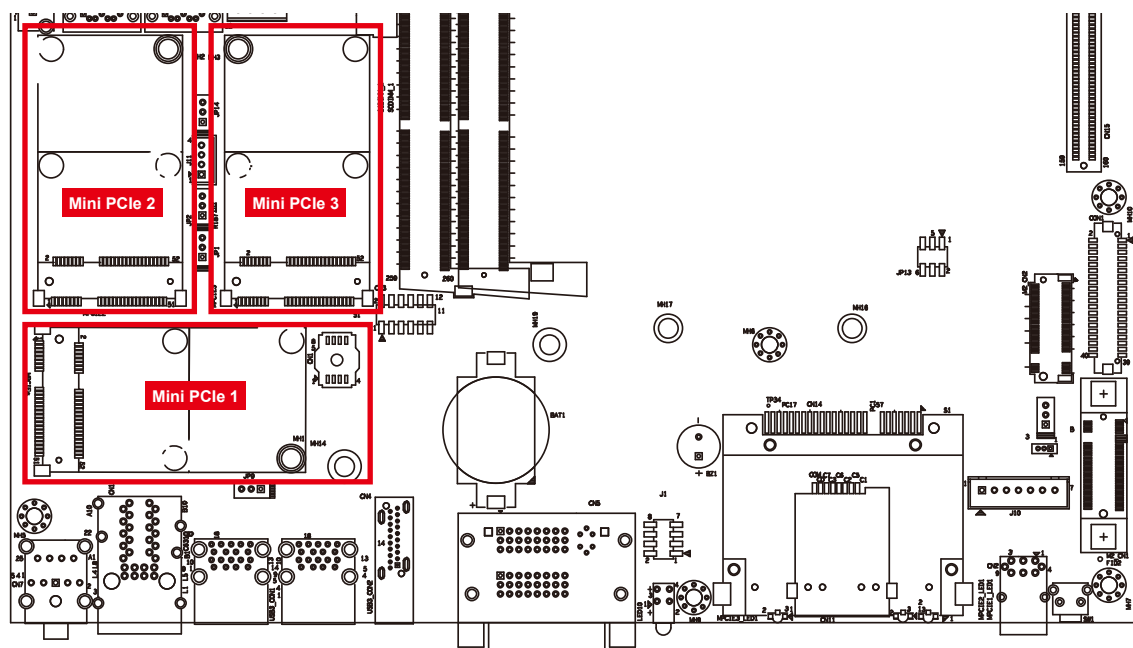



Pin Out:

Pin No.	function	Pin No.	function
51	Reserved	52	+3.3Vaux
49	Reserved	50	GND
47	Reserved	48	+1.5V
45	Reserved	46	Reserved
43	GND	44	Reserved
41	+3.3Vaux	42	Reserved
39	+3.3Vaux	40	GND
37	GND	38	USB_D+
35	GND	36	USB_D-
33	PETp0	34	GND
31	PETn0	32	SMB_DATA
29	GND	30	SMB_CLK
27	GND	28	+1.5V
25	PERn0	26	GND
23	PERp0	24	+3.3Vaux
21	GND	22	PERST#
19	Reserved	20	reserved
17	Reserved	18	GND
Mechanical Key			
15	GND	16	UIM_VPP
13	REFCLK+	14	UIM_RESET
11	REFCLK-	12	UIM_CLK
9	GND	10	UIM_DATA
7	CLKREQ#	8	UIM_PWR
5	Reserved	6	1.5V
3	Reserved	4	GND
1	WAKE#	2	3.3Vaux

## 2.4.12 RTC Battery

The system's real-time clock is powered by a lithium battery. It is equipped with Panasonic BR2032 190mAh lithium battery. It is recommended that you do not have to get the lithium battery on your own. If the battery needs to be changed, please contact the Vecow RMA service team.

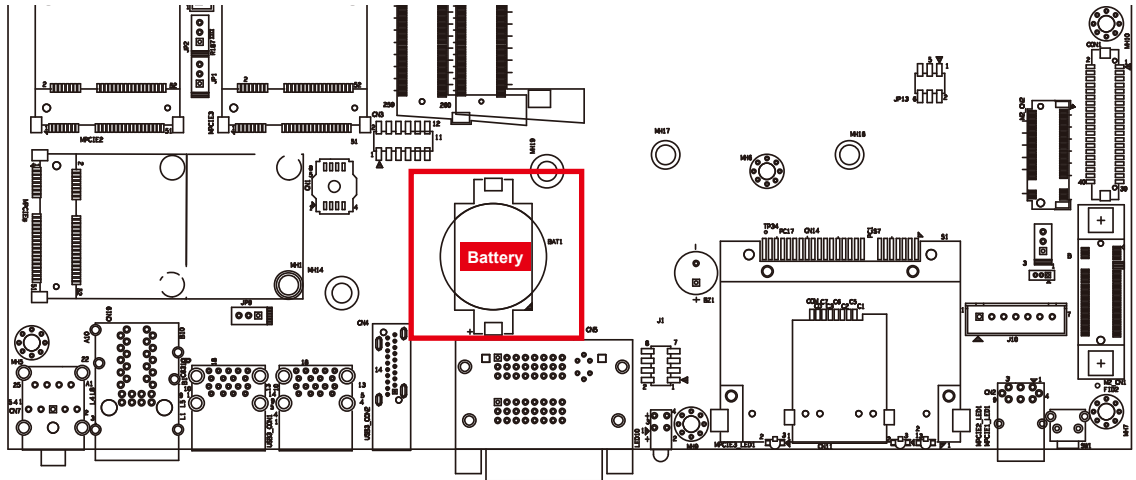

## 2.4.13 FAN Header

Fan power connector supports for additional thermal requirements. The pin assignments of FAN 1 and FAN 2 are listed in the following table:

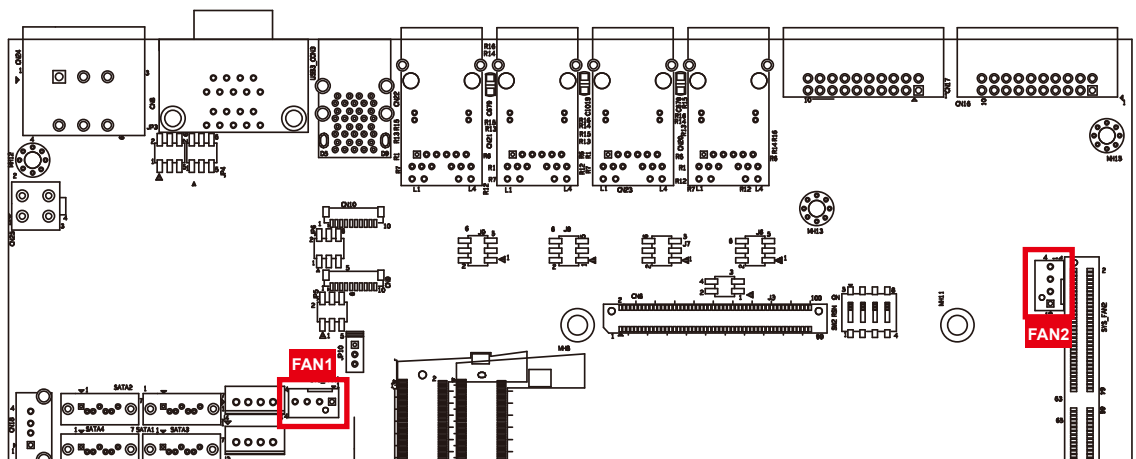

Pin out:

Pin No.	Function	Pin No.	Function
1	GND	2	+12V (1.5A max)
3	Fan speed sensor	4	Fan PWM

## 2.4.14 LPC Port 80 Header

ECS-9200/9100 GTX1050 provides a LPC Port 80 Header for Debug Card.

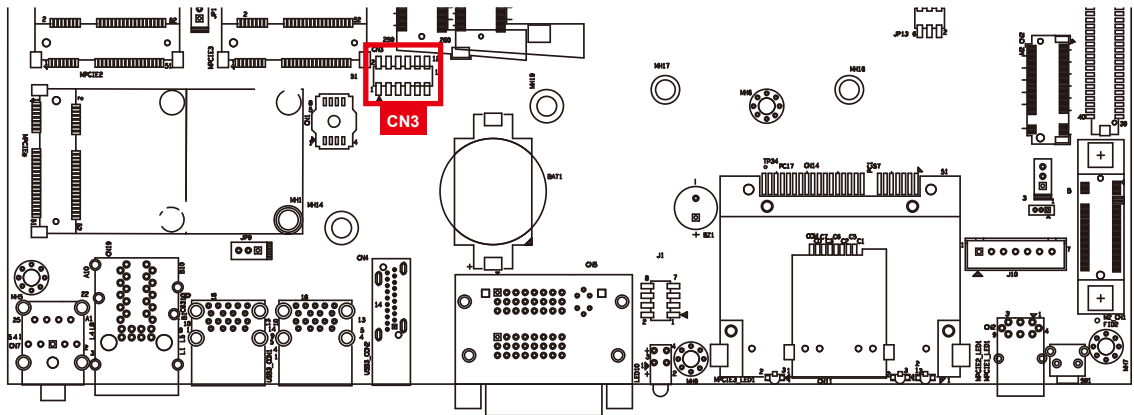

Pin out:

Pin No.	Function	Pin No.	Function
1	SERIRQ	7	LFRAME#
2	+3.3V	8	LAD0
3	LA3	9	N/C
4	RESET#	10	Ground
5	LAD1	11	CLOCK
6	LAD2	12	Ground

## 2.4.15 LAN IEEE 1588 Header

ECS-9200 GTX1050 provides a LAN header for IEEE 1588.

LAN No.	Function	Function
Rear POE LAN3	Intel I210	J6
Rear POE LAN4	Intel I210	J7
Rear POE LAN5	Intel I210	J8
Rear POE LAN6	Intel I210	J9

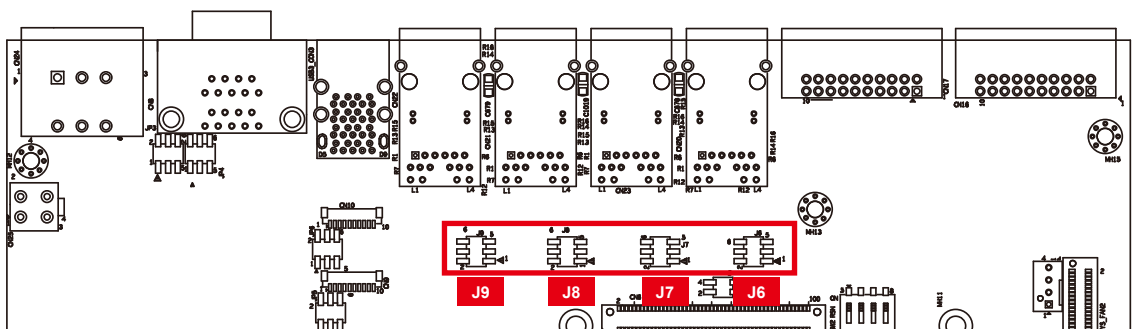

Pin out:

Pin No.	Function	Pin No.	Function
1	SPD0	2	SPD1
3	SPD2	4	SPD3
5	Ground	6	Ground

## 2.4.16 COM Port Header

ECS-9200/9100 GTX1050 provides 4 COM port headers for internal COM port cable.

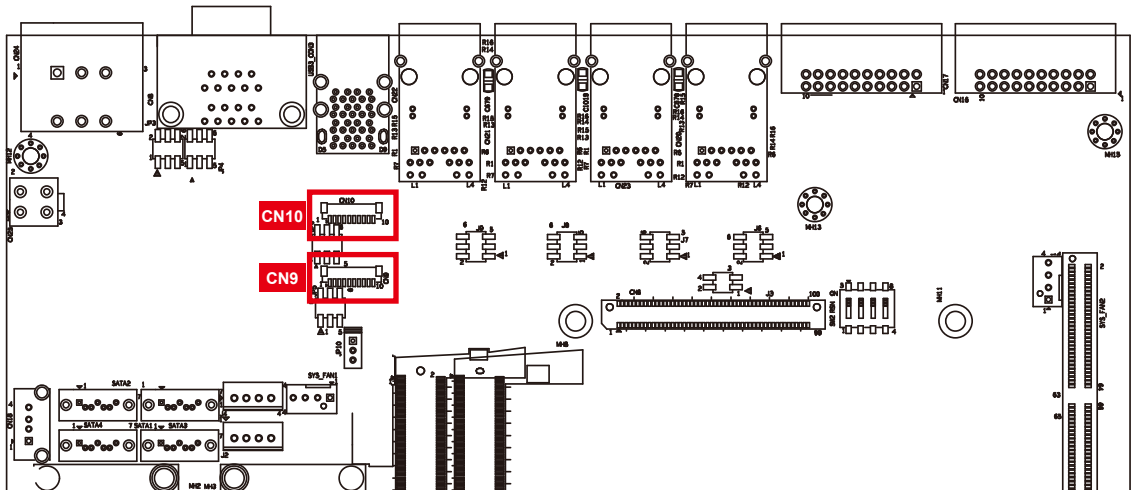

Pin out:

CN9:

Pin No.	Description	Port
1	Ground_Frame	COM3
2	Ground	COM3
3	RI	COM3
4	DTR	COM3
5	CTS	COM3
6	TXD	COM3
7	RTS	COM3
8	RXD	COM3
9	DSR	COM3
10	DCD	COM3

CN10:

Pin No.	Description	Port
1	Ground_Frame	COM4
2	Ground	COM4
3	RI	COM4
4	DTR	COM4
5	CTS	COM4
6	TXD	COM4
7	RTS	COM4
8	RXD	COM4
9	DSR	COM4
10	DCD	COM4

## 2.5 Main Board Jumper & Deep Switch Settings

### 2.5.1 Top View of ECS-9200/9100 GTX1050 Main Board With Jumper and DIP Switch

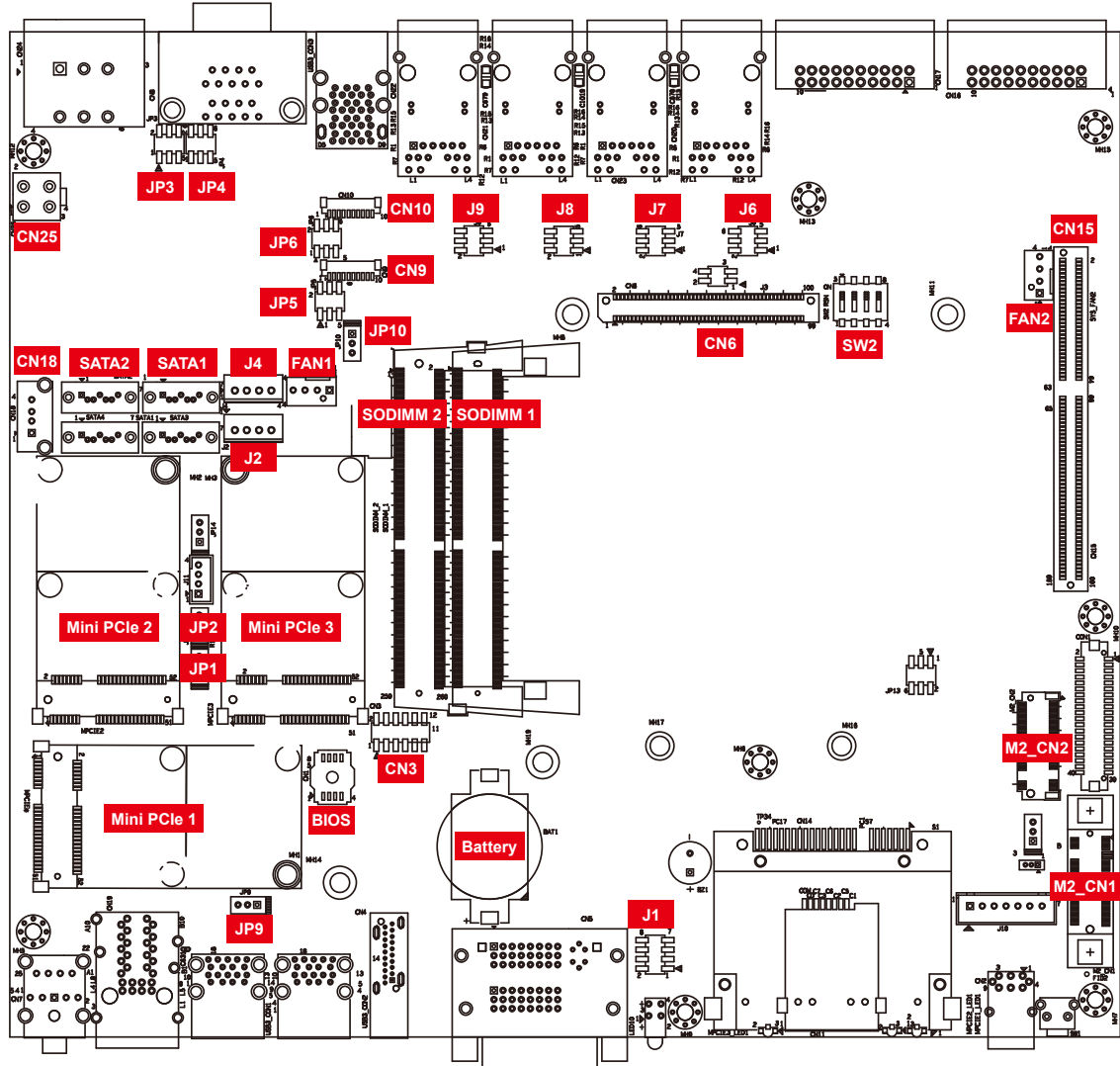

The figure below is the top view of ECS-9200/9100 GTX1050 main board which is the main board. It shows the location of the jumpers and the switches.

You may configure your card to match the needs of your application by setting jumpers. A jumper is a metal bridge used to close an electric circuit. It consists of two metal pins and a small metal clip (often protected by a plastic cover) that slides over the pins to connect them. To “close” a jumper, you connect the pins with the clip. To “open” a jumper, you remove the clip. Sometimes a jumper will have three pins, labeled 1, 2 and 3. In this case you would connect either pins 1 and 2, or 2 and 3.

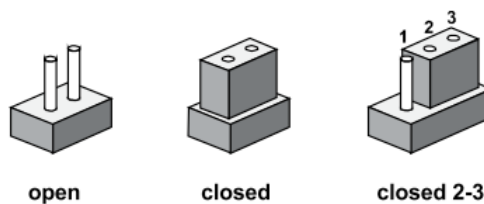

You may configure your card to match the needs of your application by DIP switch. As below show the DIP switch on and off.

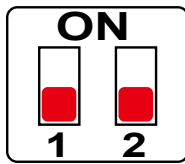

1 : OFF  
2 : OFF

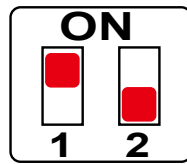

1 : ON  
2 : OFF

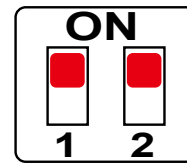

1 : ON  
2 : ON

## 2.5.2 USB Power Jumper

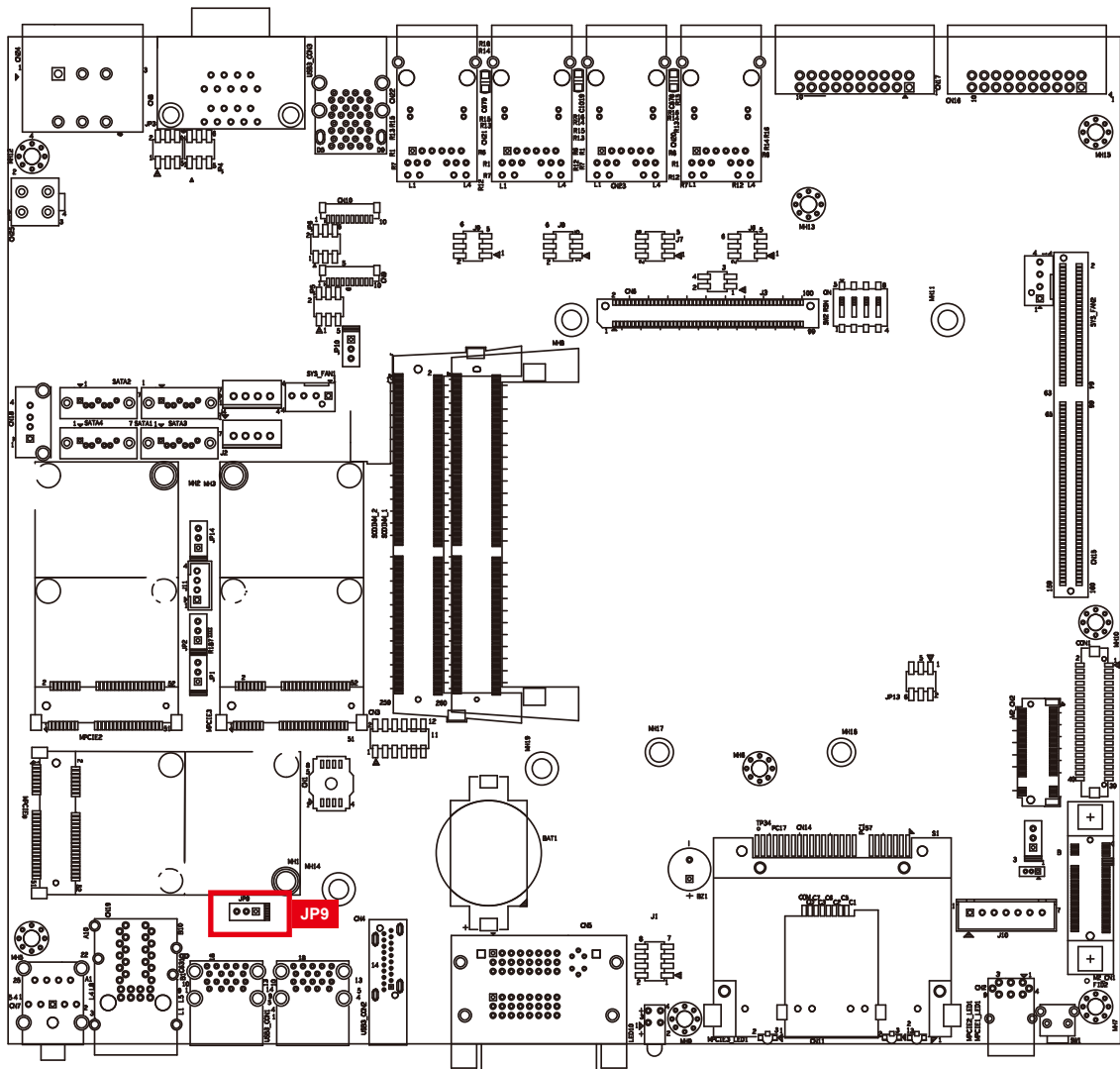

Jumper	Setting	Function
JP9	1:2	Supported Wake Up(Default)
JP9	2:3	Non Wake Up support

### 2.5.3 COM Port RI pin Select

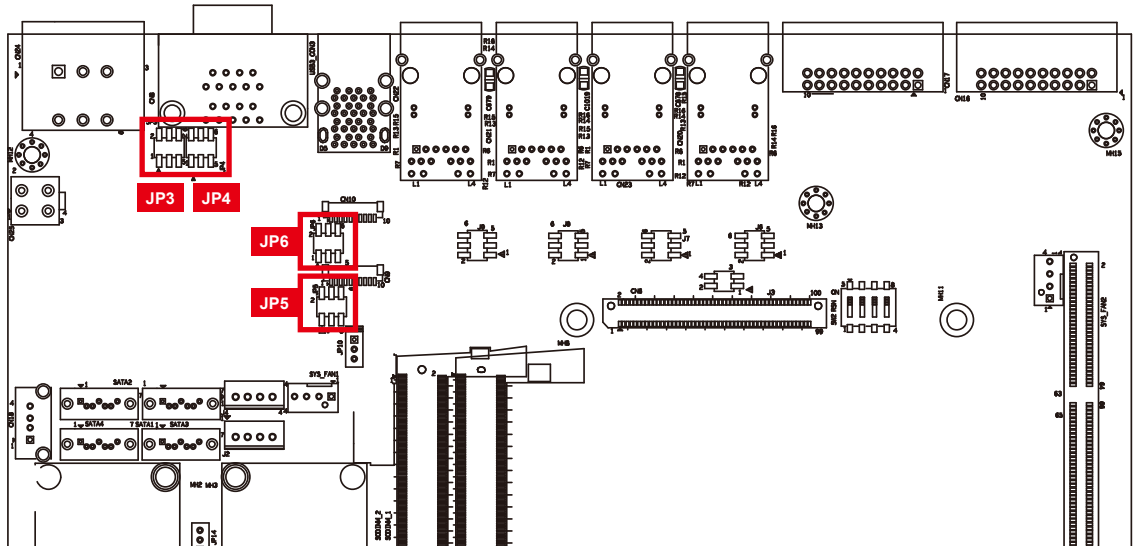

Pin Header	Pin No.	Description
COM1 JP3	1-2	+5V (1A max.)
	3-4	+12V (0.5A max.)
	5-6	RI (Default)

Pin Header	Pin No.	Description
COM2 JP4	1-2	+5V (1A max.)
	3-4	+12V (0.5A max.)
	5-6	RI (Default)

Pin Header	Pin No.	Description
COM3 JP5	1-2	+5V (1A max.)
	3-4	+12V (0.5A max.)
	5-6	RI (Default)

Pin Header	Pin No.	Description
COM4 JP6	1-2	+5V (1A max.)
	3-4	+12V (0.5A max.)
	5-6	RI (Default)

## 2.5.4 PoE Power ON Select

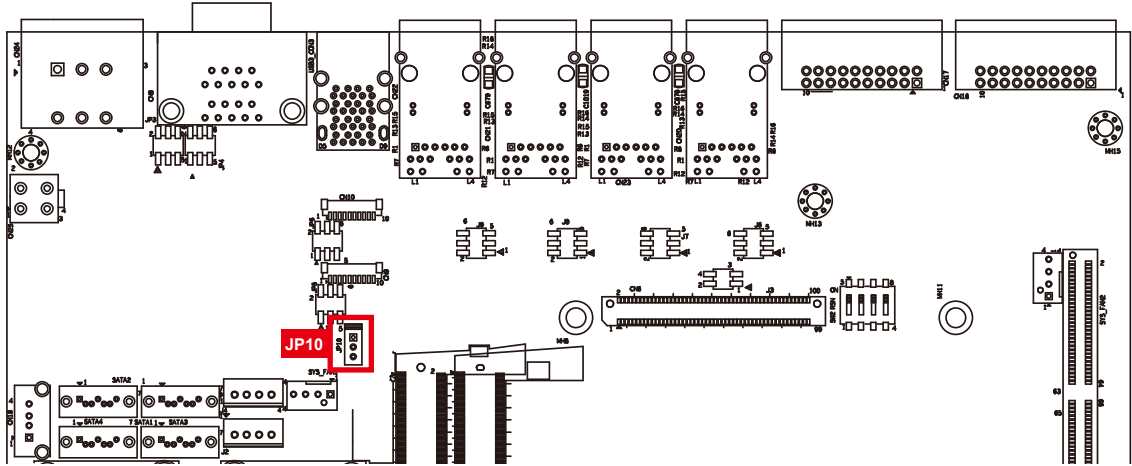

Jumper	Setting	Function
JP10	1:2	POE power on at standby power ready
JP10	2:3	POE power on after system power on (Default)

## 2.5.5 Clear CMOS/ME Switch

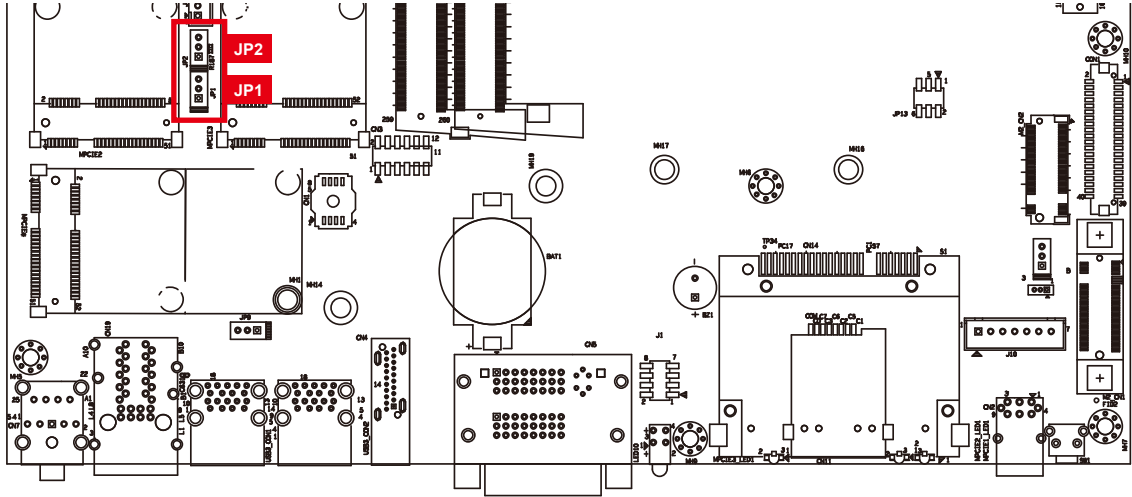

Jumper	Setting	Function
JP1	1:2	*Normal(Default)
JP1	2:3	Clear CMOS

Jumper	Setting	Function
JP2	1:2	*Normal(Default)
JP2	2:3	Clear ME



## 2.6 Ignition Control







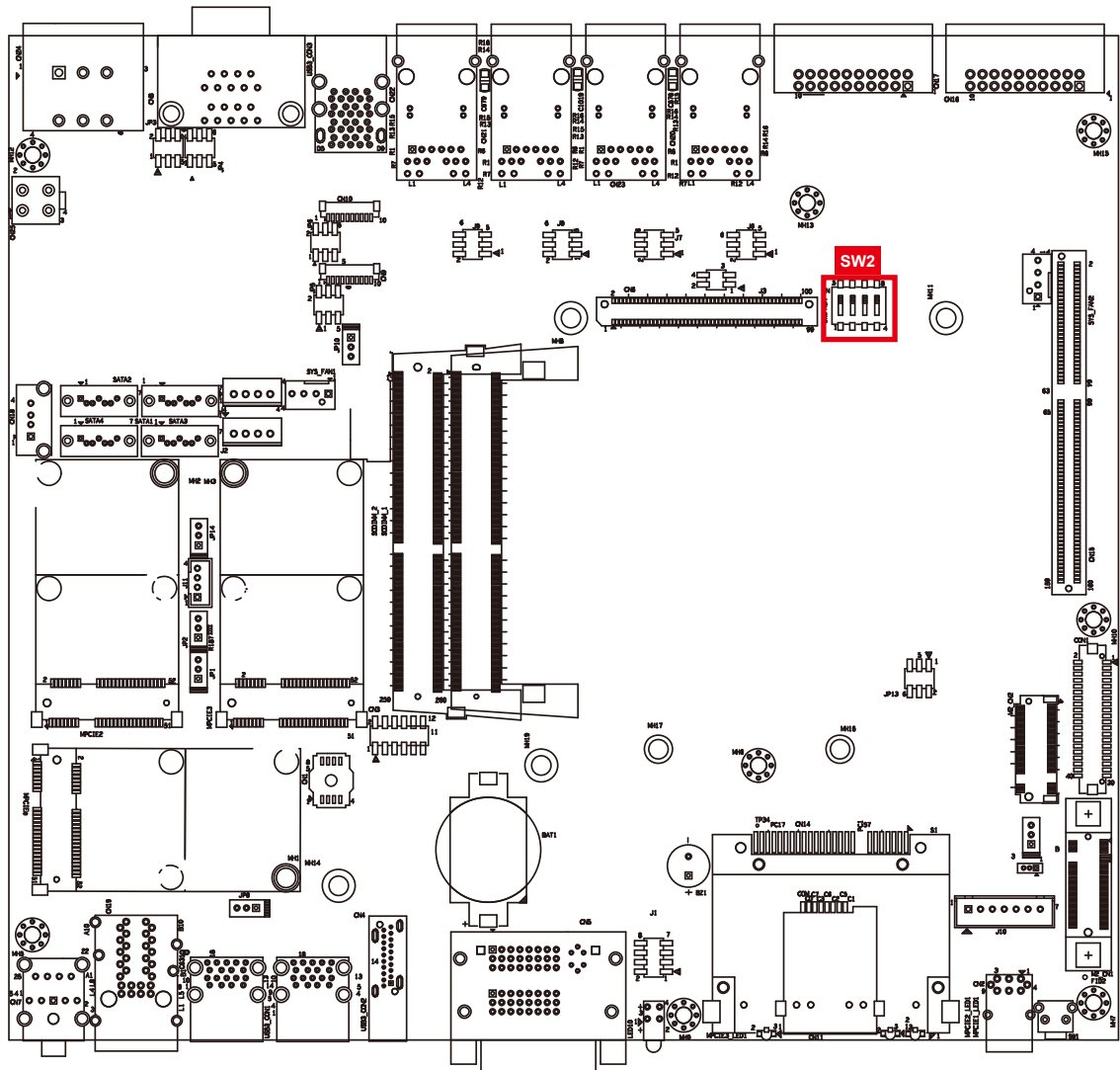



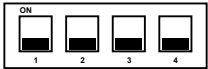



ECS-9200/9100 GTX1050 series provides ignition power control feature for in-vehicle applications. The built-in MCU monitors the ignition signal and turns on/off the system according to pre-defined on/off delay period.

### 2.6.1 Adjust Ignition Control Modes

ECS-9200/9100 GTX1050 series provides 16 modes of different power on/off delay periods adjustable via SW2 switch. The default rotary switch is set to 0 in ATX/AT power mode.

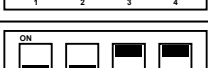

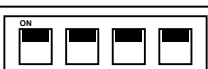
The modes are listed in the following table:

Item	Power on delay	Power off delay	Switch Position
0	ATX mode		
1	No delay	No delay	
2	No delay	5 seconds	
3	No delay	10 seconds	
4	No delay	20 seconds	
5	5 seconds	30 seconds	
6	5 seconds	60 seconds	
7	5 seconds	90 seconds	
8	5 seconds	30 minutes	
9	5 seconds	1 hour	
A	10 seconds	2 hours	
B	10 seconds	4 hours	
C	10 seconds	6 hours	
D	10 seconds	8 hours	
E	10 seconds	12 hours	
F	10 seconds	24 hours	

## 2.6.2 Ignition Control Wiring

To activate ignition control, you need to provide IGN signal via the 3-pin pluggable terminal block located in the back panel. It is below the general wiring configuration.



Pin No.	Definition
1	Ignition (IGN)
2	External Power S/W +
3	External Power S/W +

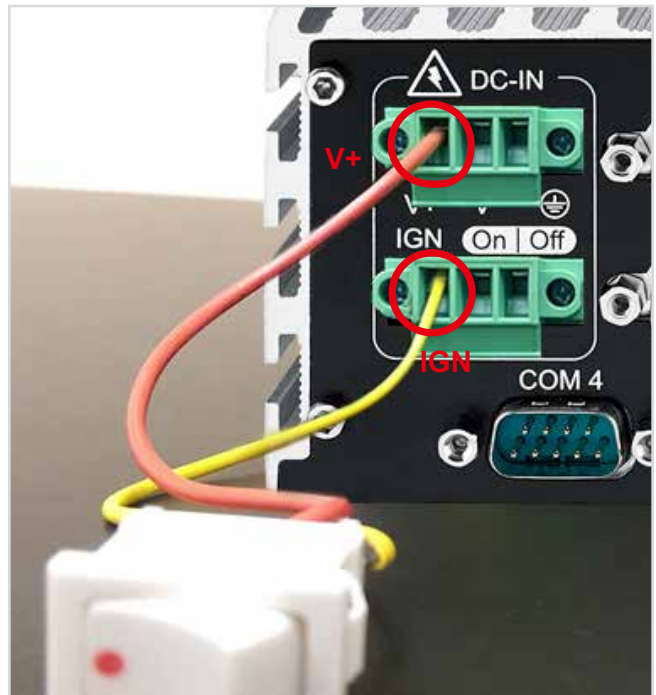

For testing purpose, you can refer to the picture below to simulate ignition signal input controlled by a latching switch.

Note:

1. DC power source and IGN share the same ground.
2. ECS-9200/9100 GTX1050 supports 6V~36V wide range DC power input in ATX/AT mode. In Ignition mode, the input voltage is fixed to 12V/24V for car battery scenario.
3. For proper ignition control, the power button setting should be "Power down" mode.

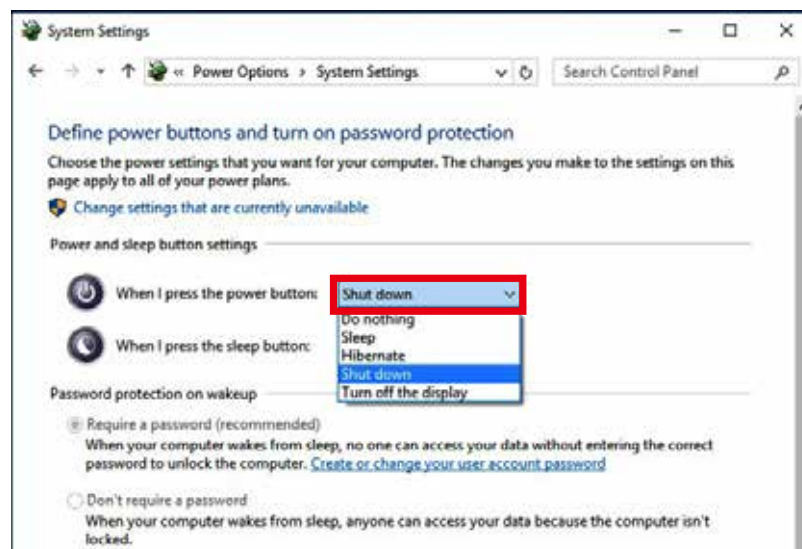

In Windows, for example, you need to set "When I press the power button" to "Shut down."

### 2.6.3 Smart Battery Protection

The system with “Ignition Control” can perform Smart Battery Protection, namely Low Battery Detection.

When the system is running on a battery and its voltage drops below the threshold, the system will automatically shut down. The Low Battery Detection is implemented in the ignition control MCU FW and as a default function.

Note:

Battery Voltage	Thresholds
12V	10.5~15V
24V	21.5~30V

# 3

## SYSTEM SETUP

### 3.1 How to Open Your ECS-9200/9100 GTX1050

**Step 1** Remove hole plugs.



**Step 2** Remove two F#6-32 screws (circled in red) and two F-M3 screws (circled in yellow) on the bottom side.



**Step 3** Finish Step1 and 2.



**Step 4** Remove one KHS#6-32x6 screw.



**Step 5** Open the module.





**Step 6** Finish.



**Step 7** Remove two F-#6-32 screws at the bottom side.



**Step 8** Remove the cover. Remove one screw KHS-#6-32 and SSD/HDD tray at front panel.

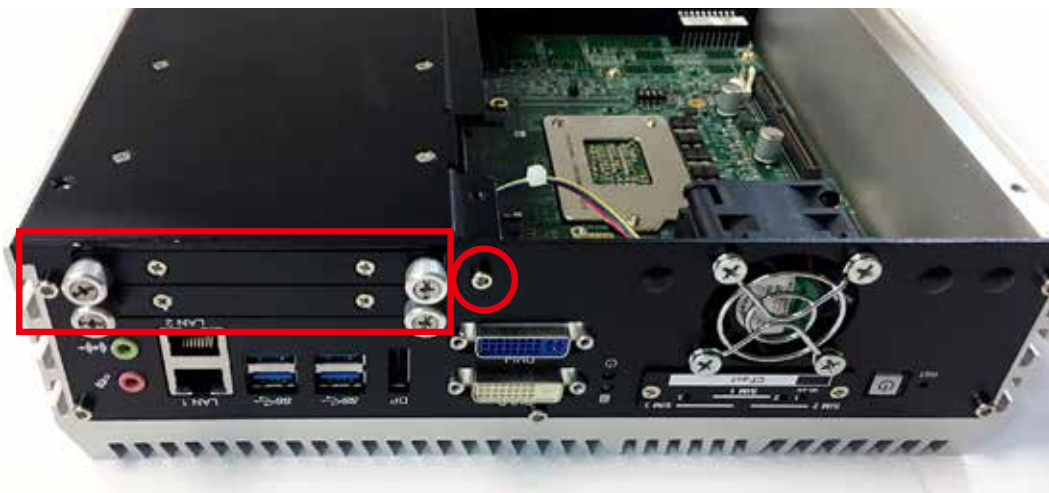

**Step 9** Remove SSD/HDD module.



**Step 10** Be careful pulling out SATA(yellow), power SATA(blue) and COM cables(red).

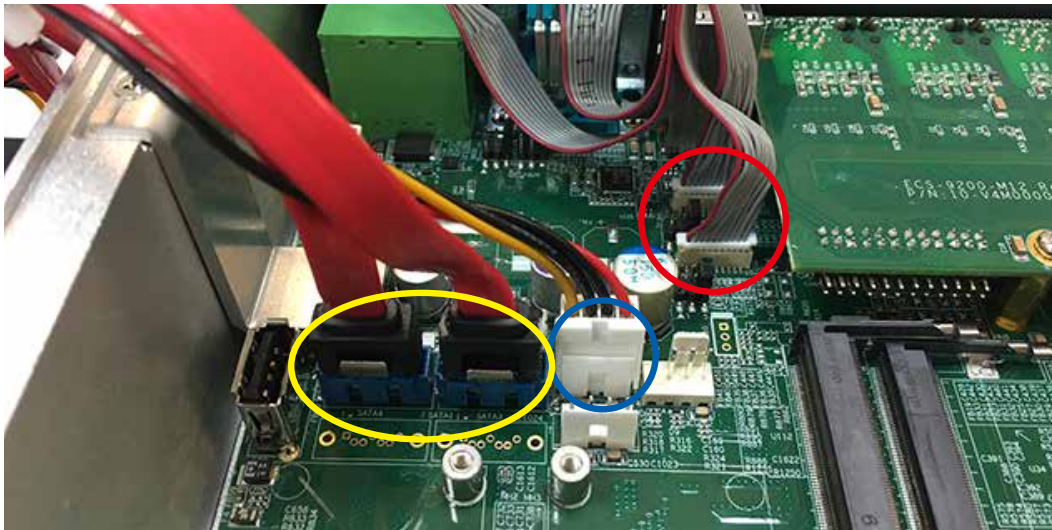

**Step 11** Remove four KHS-#6-32 screws at the rear panel.

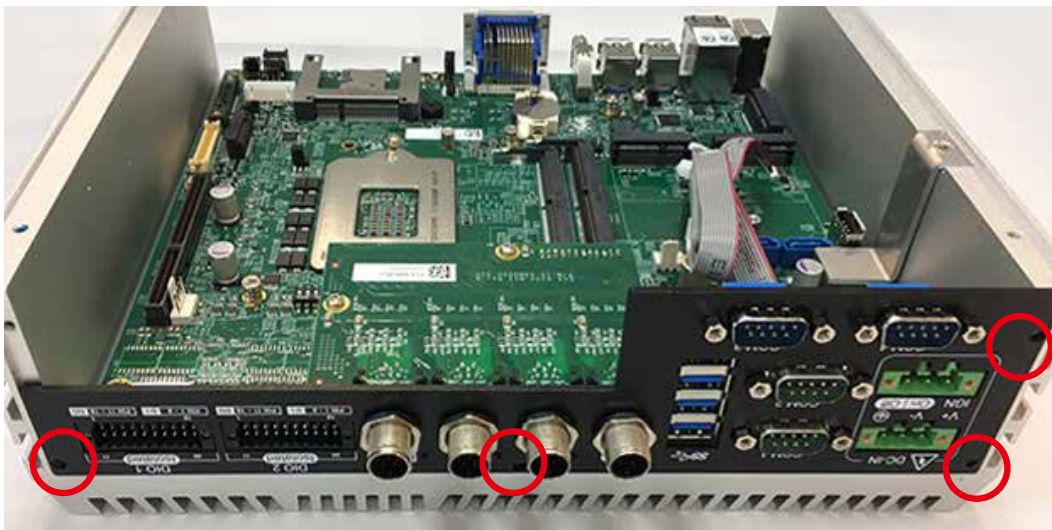



**Step 12** Finish.



## 3.2 Installing CPU

**Step 1** Remove one F #6-32 and pick up chock bracket.



**Step 2** Remove eight PH-M3 and four M3x11 spring screws and pick up mother board.

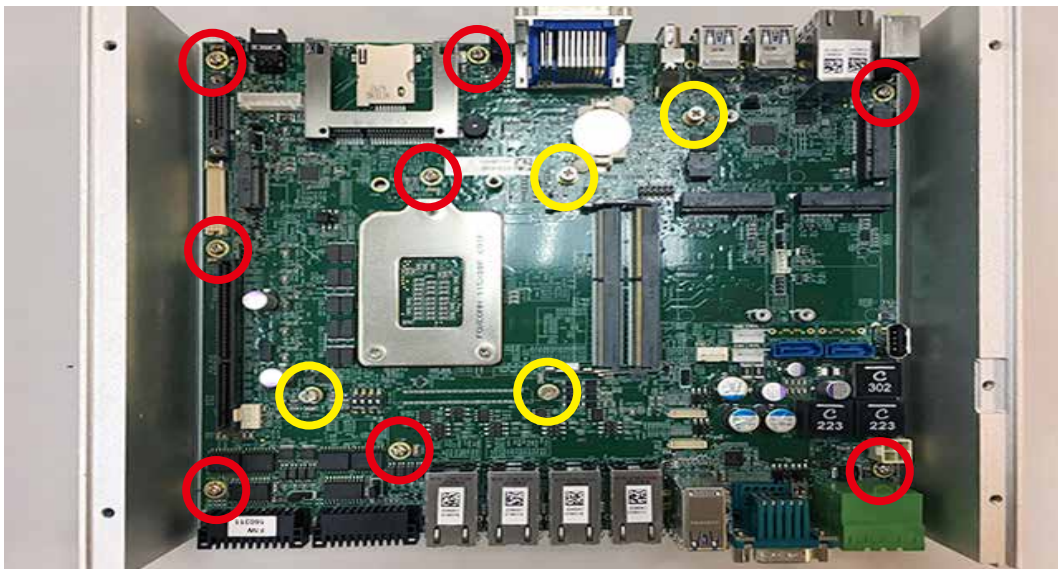



**Step 3** CPU socket.

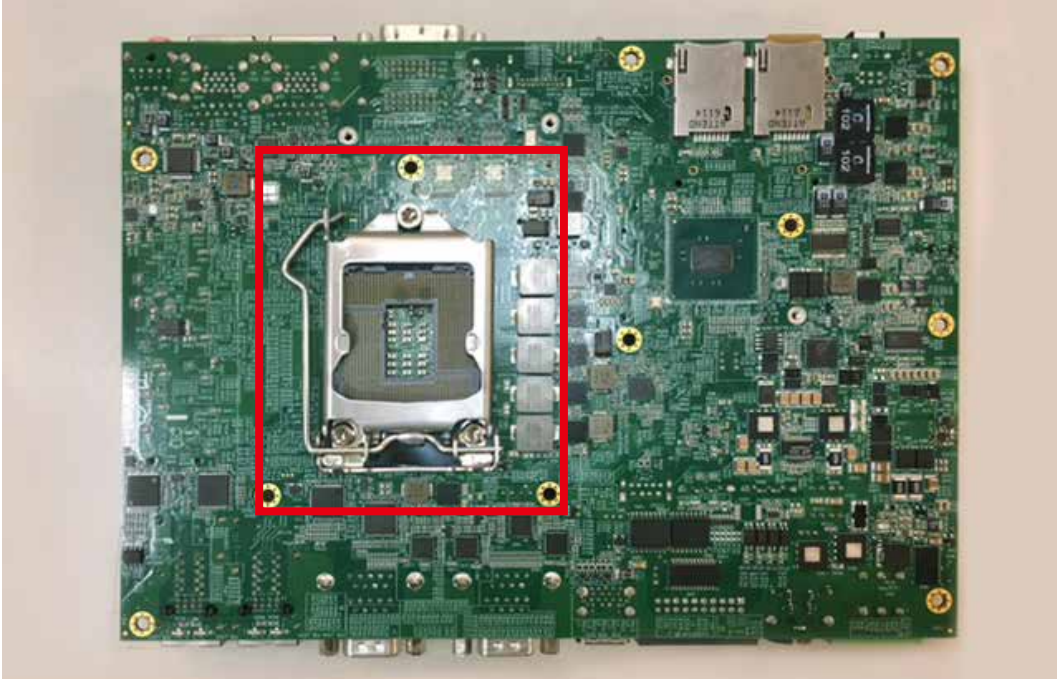

**Step 4** Open the CPU socket. (Be careful CPU pins)





**Step 5** Install CPU on the socket.

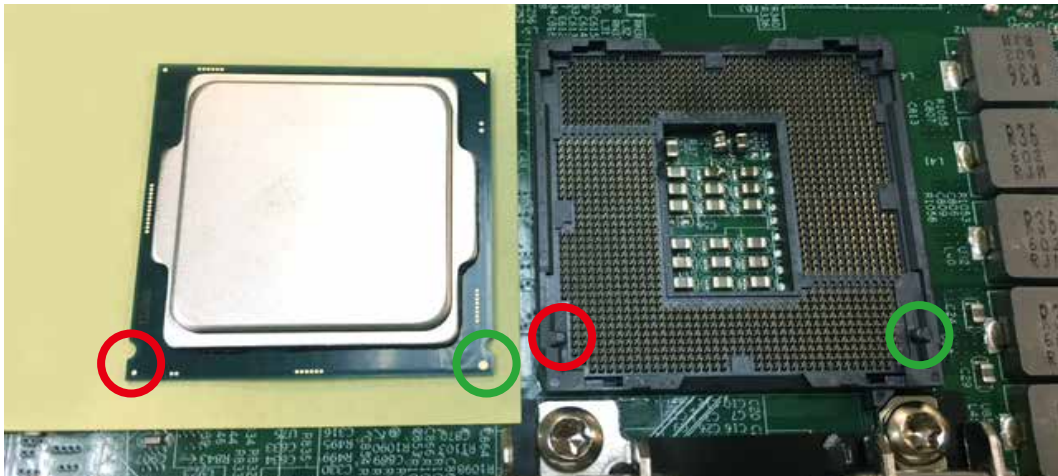

**Step 6** Finish.



**Step 7** Close CPU socket and finish.





### 3.3 Installing DDR4 SO-DIMM Modules

**Step 1** DDR4 RAM module into SO-DIMM slot.



**Step 2** Make sure the RAM module is locked by the memory slot.



### 3.4 Installing Mini PCIe Card

**Step 1** Install Mini PCIe card into the Mini PCIe socket.



**Step 2** Fasten one M2.5 screw.





### 3.5 Installing CFast Card

**Step 1** Remove 2 pcs F-M3x4 screws on CFast & SIM cover.



**Step 2** Before inserting CFast & SIM Cards, make sure the system power is not plugged.

**Step 3** Insert CFast card and push to lock.

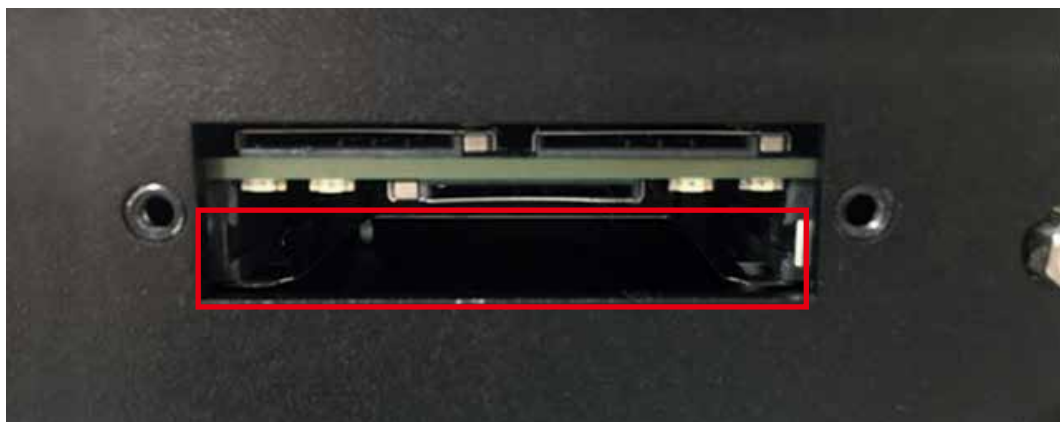

**Step 4** Finish.



## 3.6 Installing SIM Card

**Step 1** Remove 2 pcs F-M3x4 screws on CFast & SIM cover.



**Step 2** Before inserting CFast & SIM Cards, make sure the system power is not plugged.

**Step 3** Insert SIM card and push to lock.



**Step 4** Finish.



## 3.7 Installing SSD/HDD

**Step 1** Trigger and open SSD/HDD tray.



**Step 2** Insert 2.5" SSD/HDD in the tray and fasten two F-M3x4 screws.

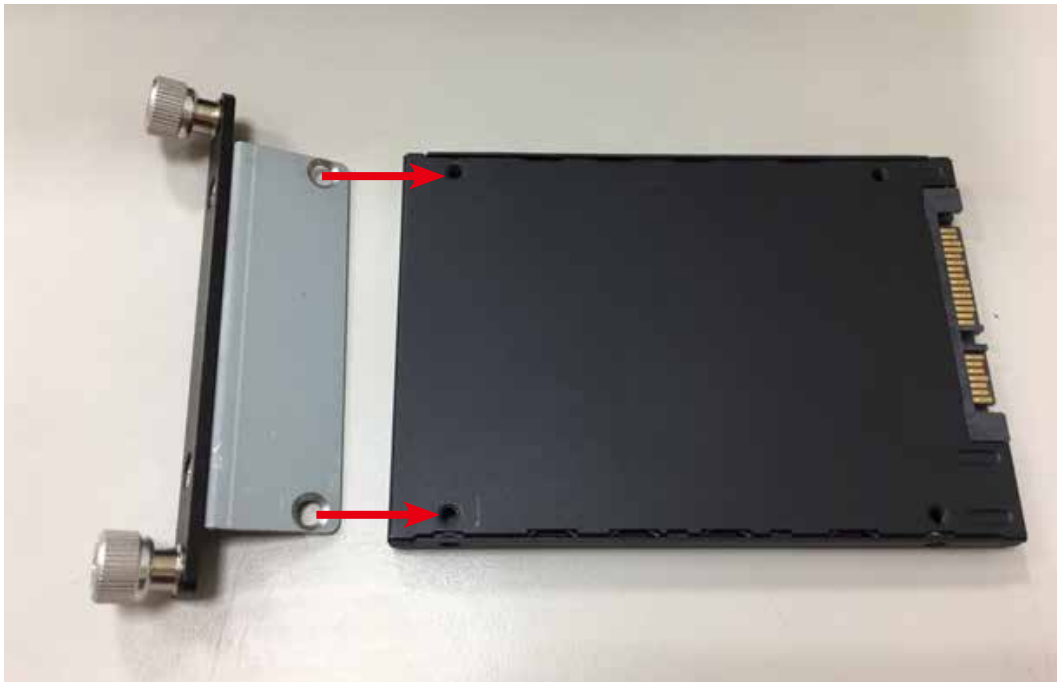



**Step 3** Finish.



**Step 4** Install SSD/HDD.



## 3.8 Installing M.2

Step 1 M.2 slot.



Step 2 Fasten one M3 screw.



## 3.9 Installing M2DOM

**Step 1** M2DOM slot.



**Step 2** M2DOM module.





**Step 3** Install M2DOM module with slot.

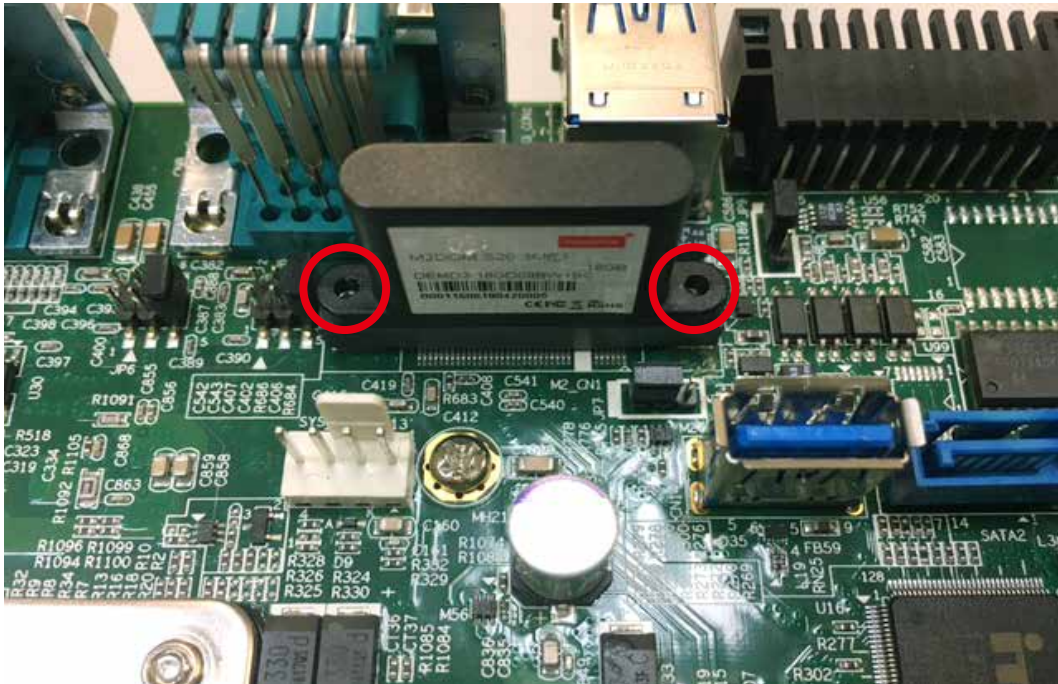

**Step 4** Lock two M2 screws with slot.



## 3.10 Mounting Your ECS-9200/9100 GTX1050

### 3.10.1 Wall Mount Bracket

**Step 1** Ensure the screw holes on the right and left sides of the upper case match the ones on ECS-9200/9100 GTX1050 wall mount bracket.



**Step 2** Fasten 4pcs KHS#6-32 screws and then finish.



### 3.10.2 VESA Mount

**Step 1** ECS-9200/9100 GTX1050 and VESA Mount.

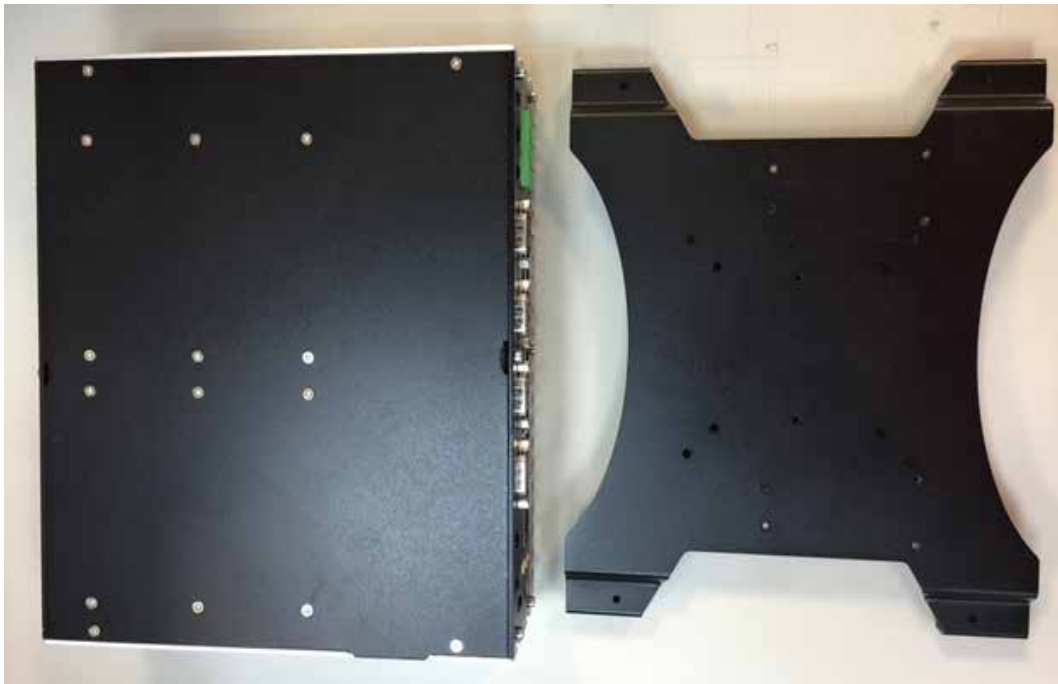

**Step 2** Take ECS-9200/9100 GTX1050 and VESA Mount with fasten 4pcs KHS#6-32 screws.



**Step 3** Fasten four KHS#6-32 screws and then finish.



**Step 4** Finish.



**Step 5** There are two sizes of VESA, 75x75mm(red) and 100x100mm(yellow).

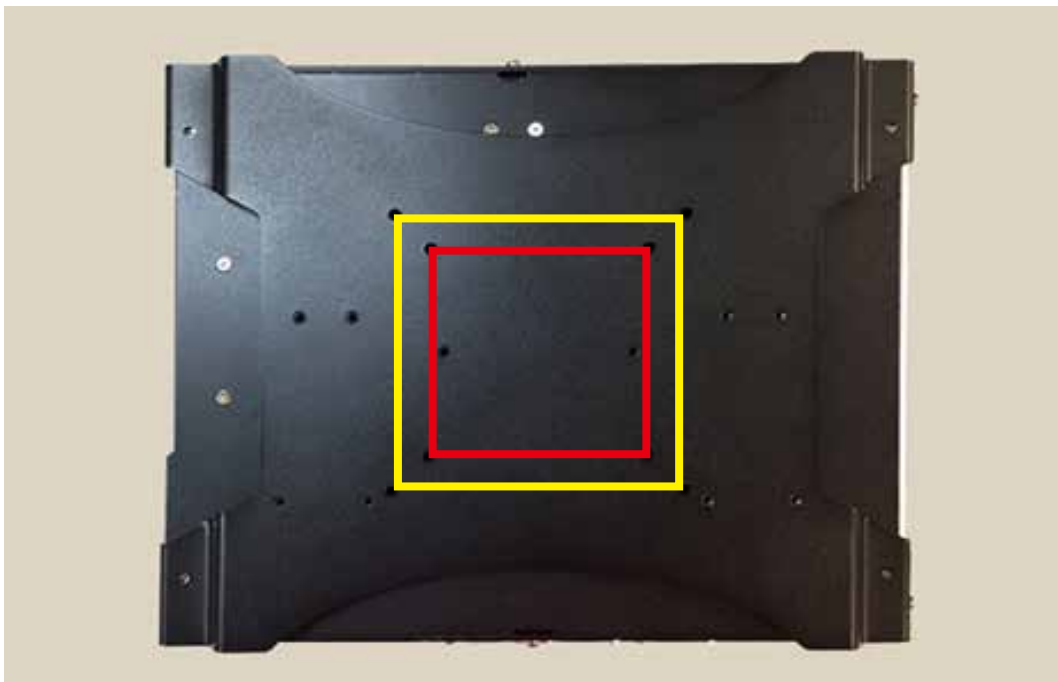



### 3.10.3 Din Rail Kit

**Step 1** ECS-9200/9100 GTX1050 and Din Rail Kit.



**Step 2** Take ECS-9200/9100 GTX1050 and Din Rail Kit and fasten four KHS#6-32 screws in the four marked corners.





**Step 3** Fasten four KHS#6-32 screws and then finish.



**Step 4** Finish.



**Step 5** ECS-9200/9100 GTX1050 With Din Rail.



# 4

## BIOS SETUP

### 4.1 Entering BIOS SETUP

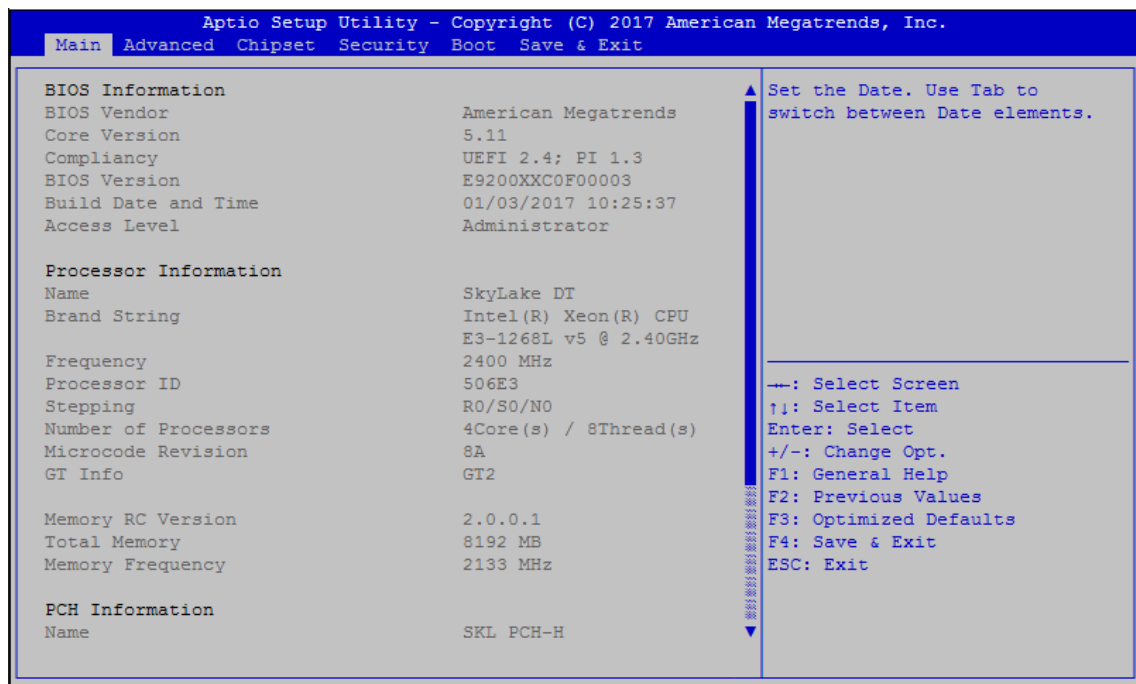

Figure 4-1: Entering Setup Screen

BIOS provides an interface for users to check and change system configuration. The BIOS setup program is accessed by pressing the <Del> key when POST display output is shown.

## 4.2 Main

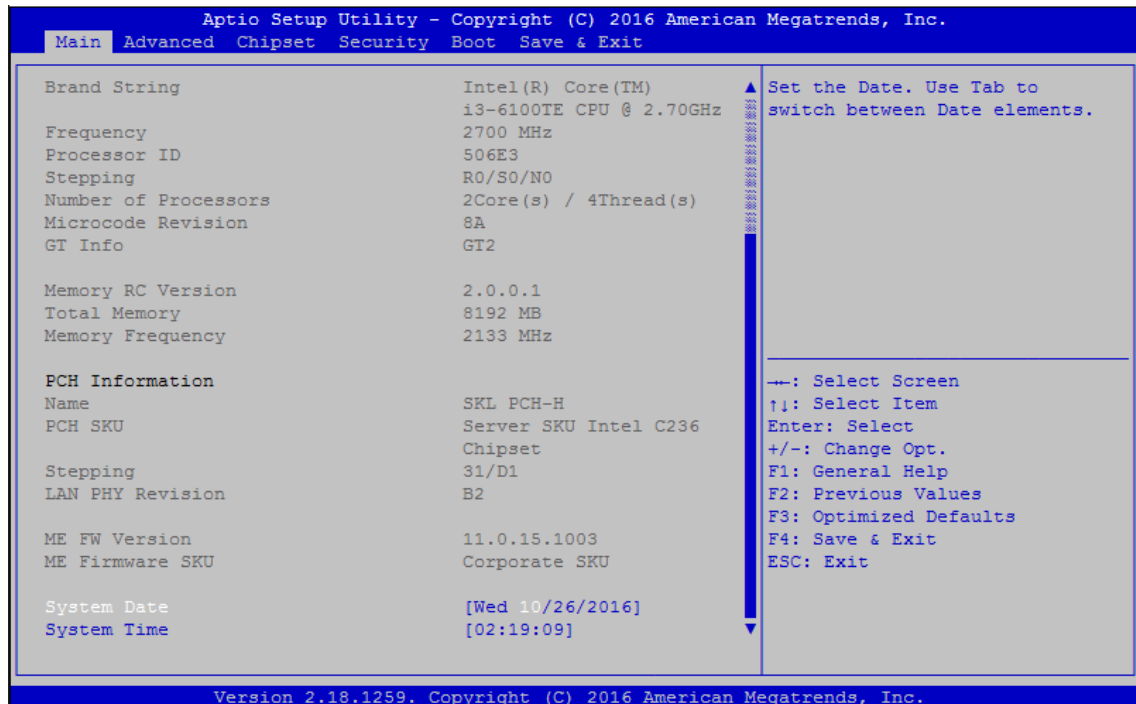

Figure 4-2: BIOS Main Menu

The main menu displays BIOS version and system information. There are two options on Main menu, system date and system time.

### System Date

Set the date. Use <Tab> to switch between date elements.

### System Time

Set the time. Use <Tab> to switch between time elements.

## 4.3 Advanced

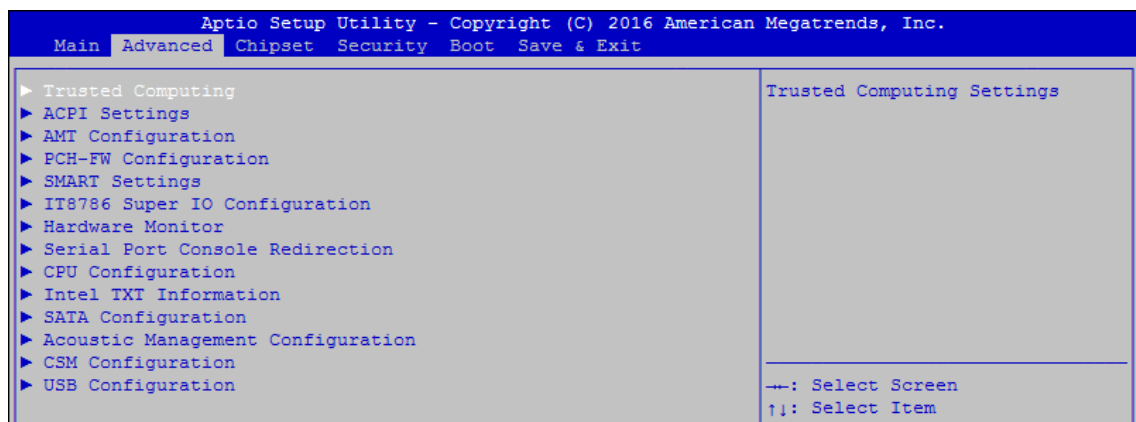

Figure 4 3: BIOS Advanced Menu

Select advanced tab to enter advanced BIOS setup options such as CPU configuration, SATA configuration, and USB configuration.

### 4.3.1 ACPI Settings

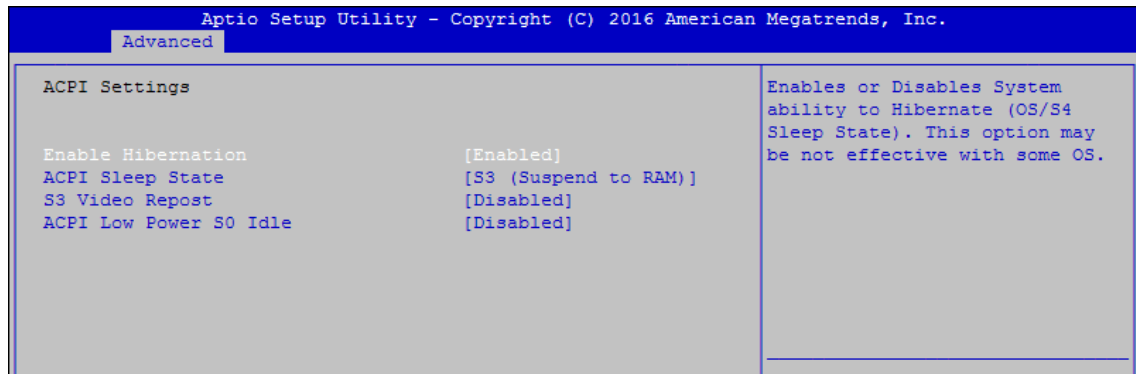

Figure 4 3-1: ACPI Settings

#### Enable Hibernation

Enables or disables system's ability to hibernate (OS/S4 sleep state). This option may not be effective with some OS.

#### ACPI Sleep State

Selects the highest ACPI sleep state the system will enter when the SUSPEND button is pressed.

#### S3 Video Repost

Enables or disables S3 video repost.

#### ACPI Low Power S0 Idle

Enables or disables ACPI low power S0 idle support.

### 4.3.2 AMT Configuration

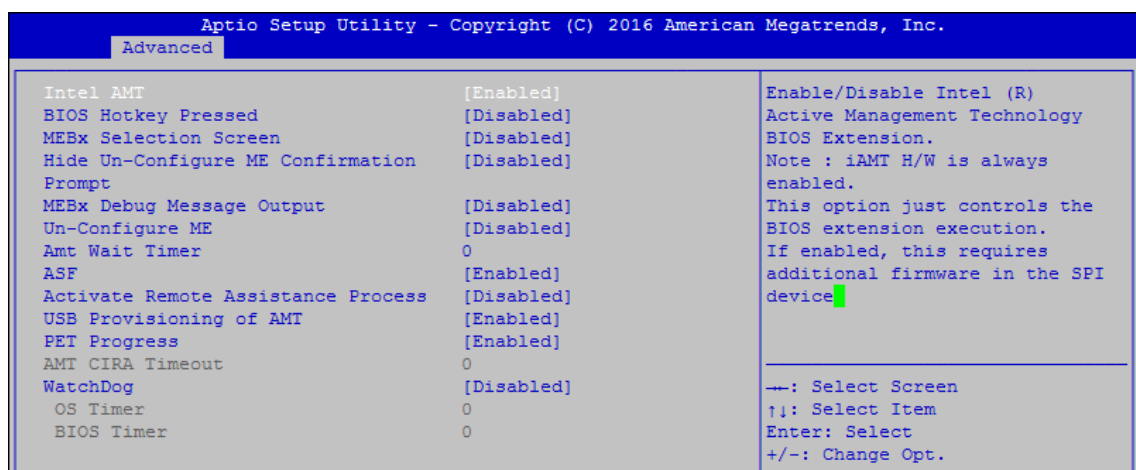

Figure 4 3-2: Intel AMT Settings

#### Intel AMT

Enables/disables Intel (R) Active Management Technology BIOS extension. Note: iAMT H/W is always enabled. This option just controls the BIOS extension execution. If enabled, this requires additional firmware in the SPI device.

### 4.3.3 PCH-FW Configuration

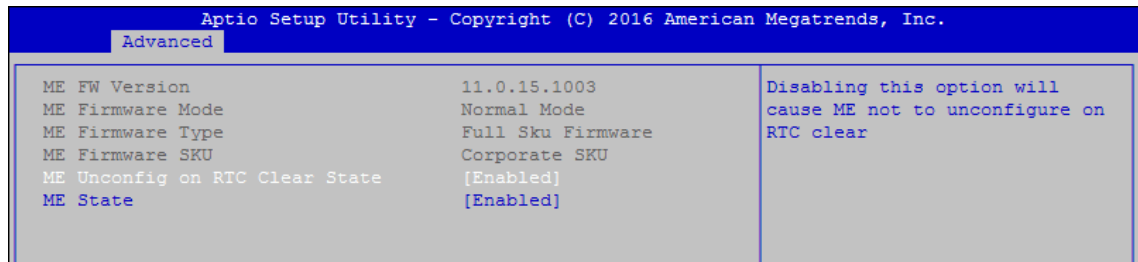

Figure 4 3-3: PCH-FW Settings

#### ME Unconfig on RTC Clear State

Disabling this option will cause ME not to unconfigure on RTC clear.

#### ME State

Set ME to Soft temporarily disabled.

### 4.3.4 SMART Settings

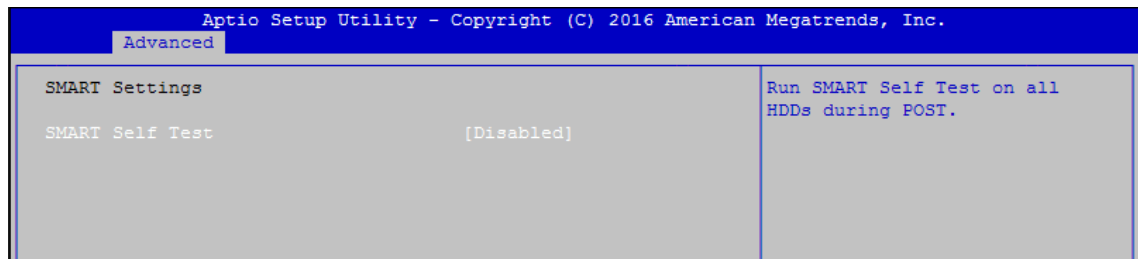

Figure 4 3-4: SMART Settings

#### SMART Self Test

Run SMART self test on all HDDs during POST.

### 4.3.5 IT8786 Super IO Configuration

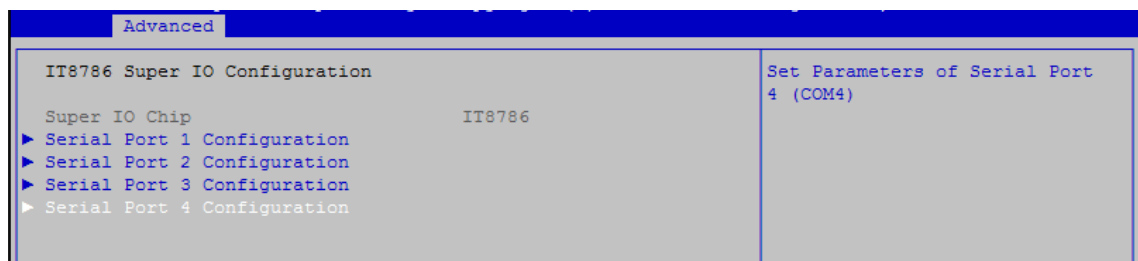

Figure 4-3-5: Super IO Settings

#### Serial Port 1 Configuration

Set parameters of serial port 1 (COM 1).

#### Serial Port 2 Configuration

Set parameters of serial port 2 (COM 2).

### Serial Port 3 Configuration

Set parameters of serial port 3 (COM 3).

### Serial Port 4 Configuration

Set parameters of serial port 4 (COM 4).

## 4.3.6 Hardware Monitor

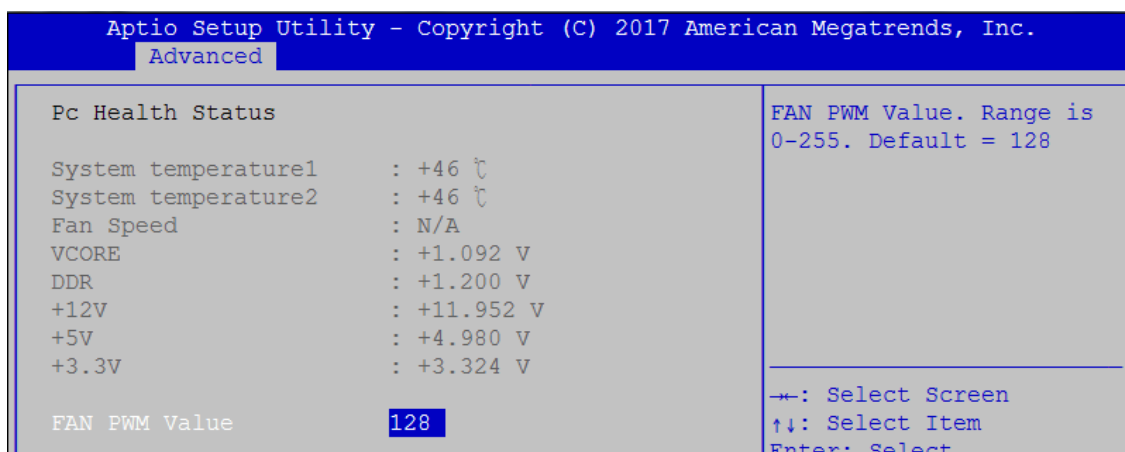

Figure 4 3-6: Hardware Monitor Settings

The IT8786 SIO features an enhanced hardware monitor providing thermal, fan speed, and system voltages' status monitoring.

### FAN PWM Value

FAN PWM Value Range is from 0 to 255. (Default at128)

## 4.3.7 Serial Port Console Redirection

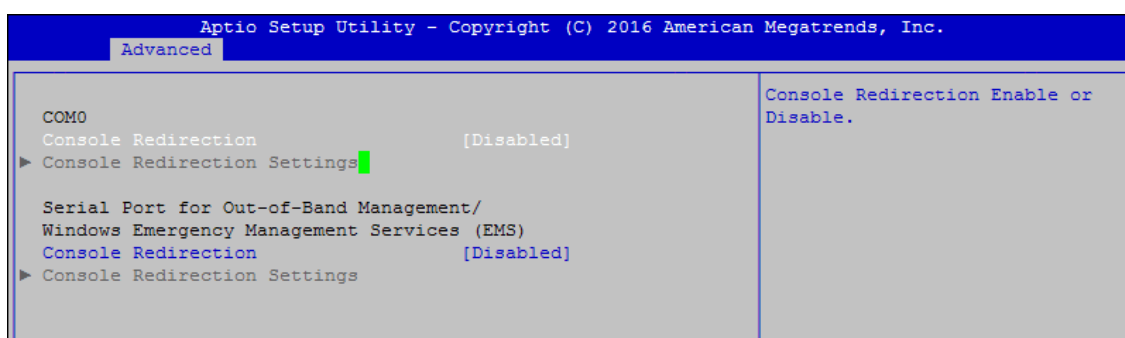

Figure 4 3-7: Serial Port Console Redirection Settings

### Console Redirection

Console redirection enable or disable.

### Console Redirection Settings

The settings specify how the host computer and the remote computer (which the user is using) will exchange data. Both computers should have the same or compatible settings.

## 4.3.8 CPU Configuration

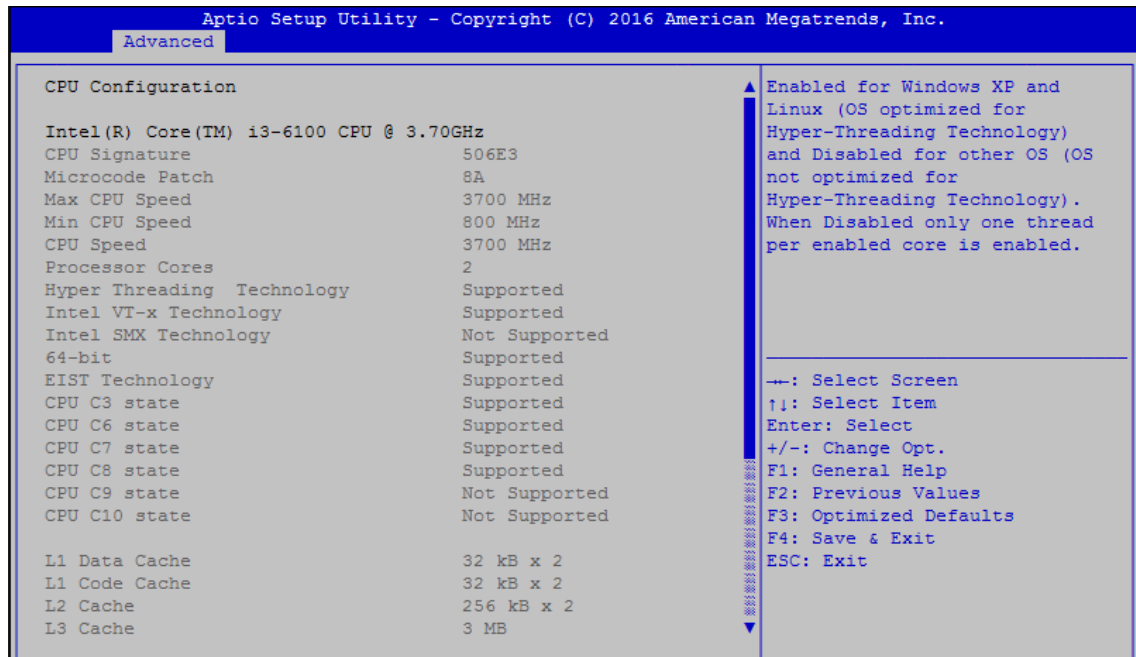

Figure 4 3-8: CPU Function Settings

### Hyper-threading

Enabled for Windows XP and Linux (OS optimized for Hyper-Threading Technology) and disabled for other OS (OS not optimized for Hyper-Threading Technology). When disabled, only one thread per core is enabled.

### Active Processor Cores

Number of cores to enable in each processor package.

### Intel Virtualization Technology

When enabled, a VMM can utilize the additional hardware capabilities provided by Vanderpool Technology.

### Hardware Prefetcher

To turn on/off the MLC streamer prefetcher.

### Adjacent Cache Line Prefetch

To turn on/off prefetching of adjacent cache lines.

### CPU AES

Enable/disable CPU Advanced Encryption Standard instructions.

### Boot performance mode

Select the performance state that the BIOS will set before OS handoff.

### Intel(R) SpeedStep(tm)

Allows more than two frequency ranges to be supported.

### Turbo Mode

Turbo Mode.

### CPU C state

Enable or disable CPU C states.

### Enhanced C-states

Enable/disable C1E. When enabled, CPU will switch to minimum speed when all cores enter C-State.

### Package C State limit

Package C State limit.

### Intel TXT(LT) Support

Enables or disables Intel (R) TXT (LT) support.

## 4.3.9 Intel TXT Information

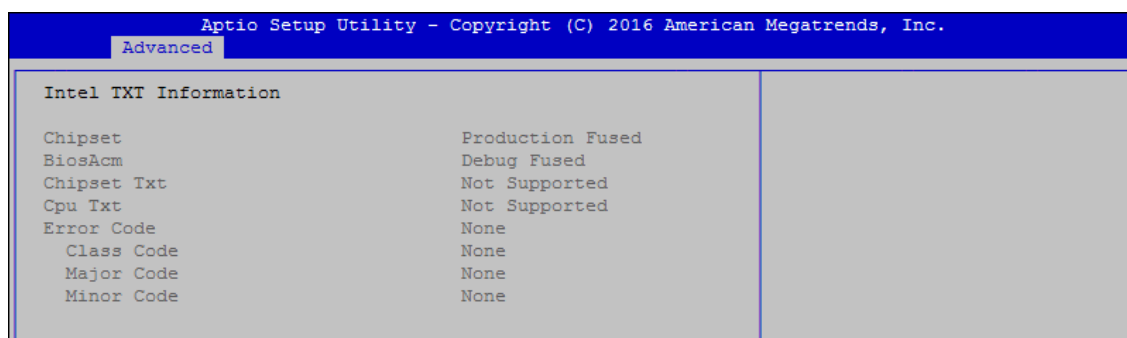

Figure 4 3-9: Intel TXT Information

Display Intel TXT information.

## 4.3.10 SATA Configuration



Figure 4 3-10: SATA Devices Settings



### SATA Controller(s)

Enable or disable SATA Device.

### SATA Mode Selection

Determines how SATA controller(s) operate.

### Software Feature Mask Configuration

RAID OROM/RST driver will refer to the SWFM configuration to enable or disable the storage features.

### Aggressive LPM Support

Enable PCH to aggressively enter link power state.

### SATA Controller Speed

Indicates the maximum speed the SATA controller can support.

### Options for each SATA port:

Port 0

Enable or disable SATA Port.

### Spin Up Device

On an edge detect from 0 to 1, the PCH starts a COMRESET initialization sequence to the device.

### SATA Device Type

Identifies that the SATA port is connected to solid state drive or hard disk drive.

## 4.3.11 Acoustic Management Configuration

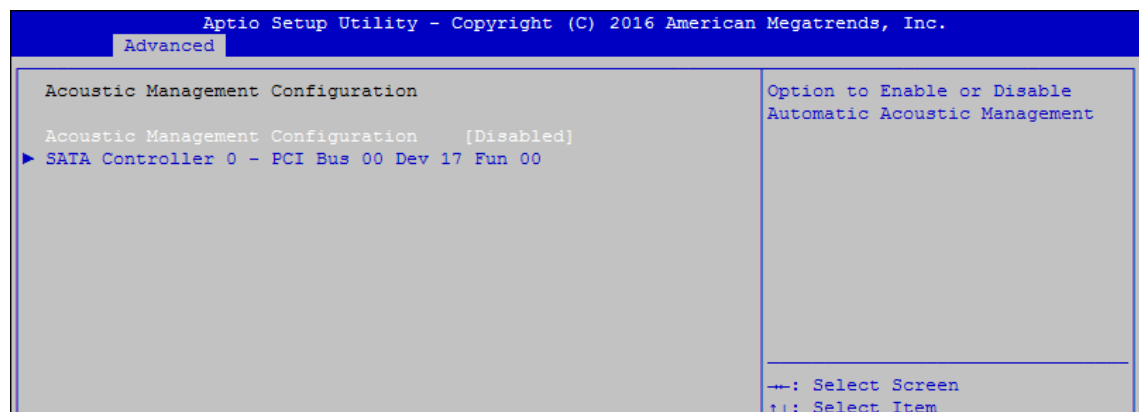

Figure 4 3-11: Acoustic Management Settings

### Acoustic Management Configuration

Option to enable or disable automatic acoustic management.

## 4.3.12 CSM Configuration

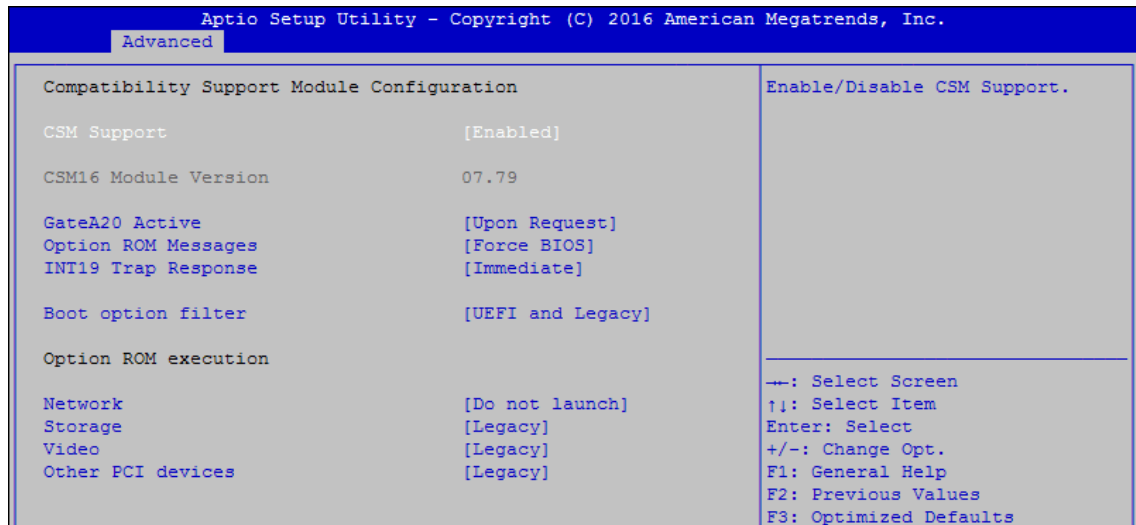

Figure 4 3-12: CSM Settings

### CSM Support

Enable/disable CSM support

### GateA20 Active

UPON REQUEST - GA20 can be disabled using BIOS services.

ALWAYS - do not allow GA20 to be disabled; this option is useful when any RT code is executed above 1MB.

### Option ROM Messages

Set display mode for Option ROM.

### INT19 Trap Response

BIOS reaction on INT19 trapping by Option ROM:

IMMEDIATE - execute the trap right away;

POSTPONED - execute the trap during legacy boot.

### Boot option filter

This option controls Legacy/UEFI ROM's priority.

### Network

Controls the execution of UEFI and Legacy PXE OpROM.

### Storage

Controls the execution of UEFI and Legacy Storage OpROM.

### Video

Allows more than two frequency ranges to be supported.

### Other PCI devices

Determines OpROM execution policy for devices other than network, storage, or video.

### 4.3.13 USB Configuration

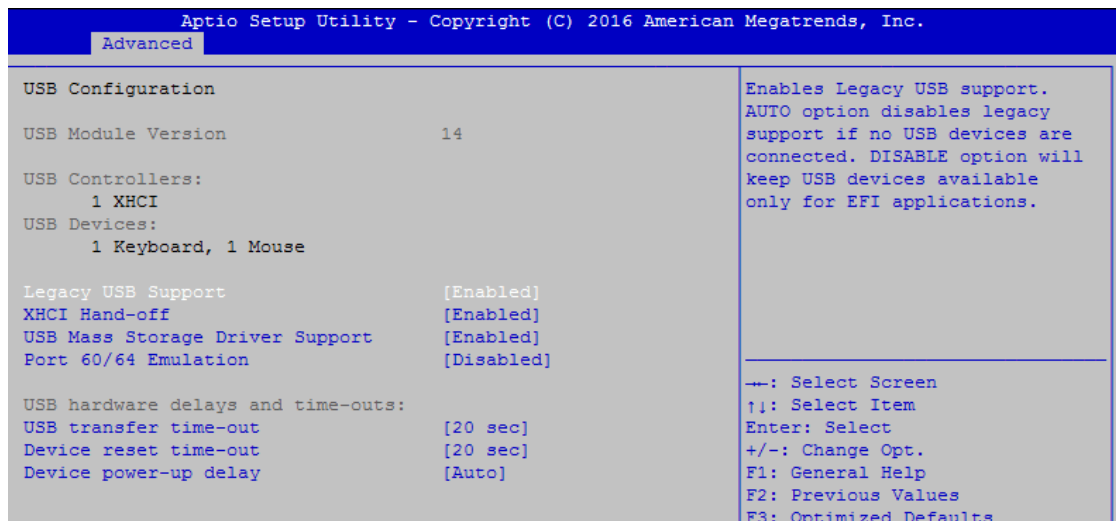

Figure 4 3-13: USB Settings

#### Legacy USB Support

Enables Legacy USB support.

AUTO option disables Legacy support if no USB devices are connected.

DISABLE option will keep USB devices available only for EFI applications.

#### XHCI Hand-off

This is a workaround for OS-es without XHCI hand-off support. The XHCI ownership change should be claimed by XHCI driver.

#### USB Mass Storage Driver Support

Enable/disable USB mass storage driver support.

#### Port 60/64 Emulation

Enables I/O port 60h/64h emulation support. This should be enabled for the complete USB keyboard legacy support for non-USB aware OS-es.

#### USB transfer time-out

The time-out value for control, bulk, and interrupt transfers.

#### Device reset time-out

USB mass storage device start unit command time-out.

#### Device power-up delay

Maximum time the device will take before it properly reports itself to the Host Controller. 'Auto' uses default value, for a root port it is 100 ms, for a hub port the delay is taken from the hub descriptor.

## 4.4 Chipset

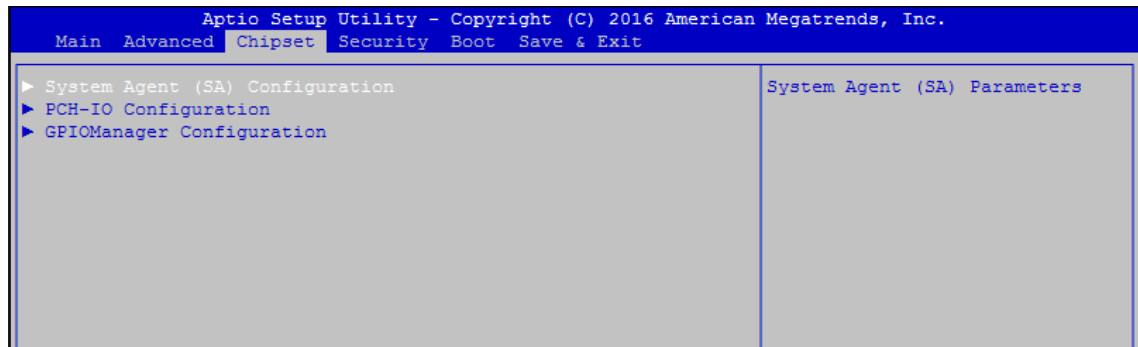

Figure 4-4: BIOS Chipset Menu

### System Agent (SA) Configuration

System Agent (SA) parameters.

### PCH-IO Configuration

PCH parameters.

### GPIOManager Configuration

GPIOManager parameters.

### 4.4.1 System Agent (SA) Configuration

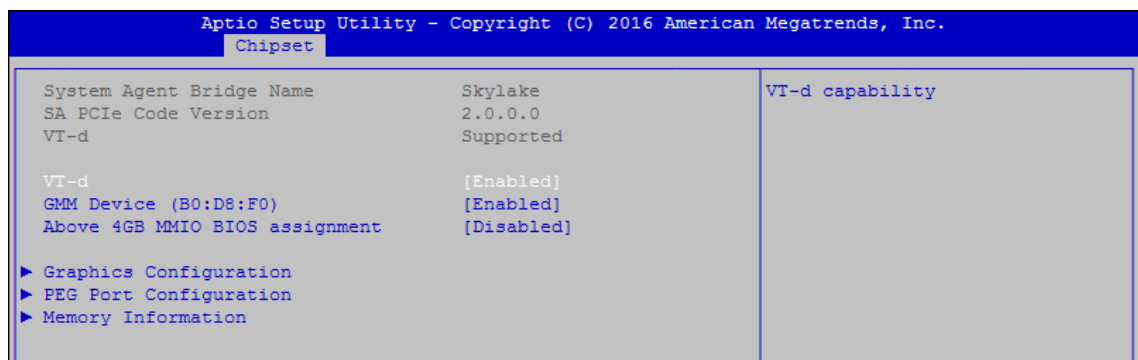

Figure 4-4-1: System Agent Settings

#### VT-d

VT-d capability.

#### GMM Device (B0:D8:F0)

Enable/disable SA GMM device.

#### Above 4GB MMIO BIOS assignment

Enable/disable above 4GB MemoryMappedIO BIOS assignment. This is disabled automatically when aperture size is set to 2048MB.

## 4.4.2 Graphics Configuration of System Agent (SA)

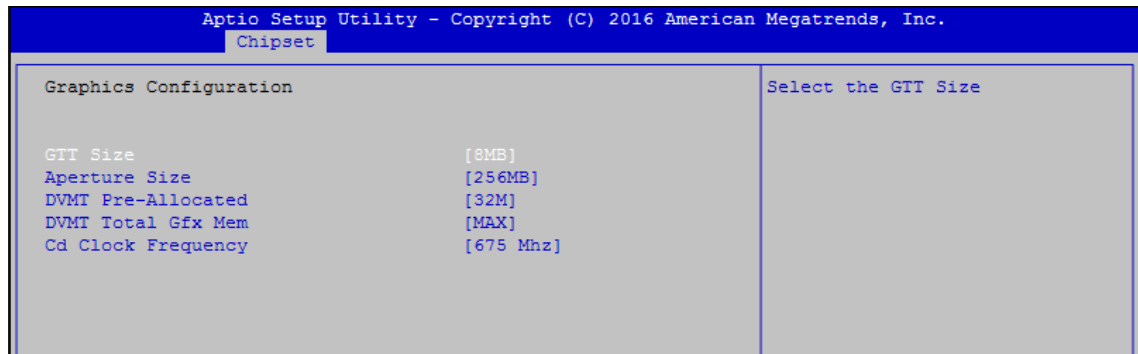

Figure 4-4-2: Graphics Settings

### GTT Size

Select the GTT Size.

### Aperture Size

Select the Aperture Size.

Note: Above 4GB MMIO BIOS assignment is automatically enabled when selecting 2048MB aperture. To use this feature, please disable CSM Support.

### DVMT Pre-Allocated

Select DVMT 5.0 Pre-Allocated (Fixed) Graphics Memory size used by the Internal Graphics Device.

### DVMT Total Gfx Mem

Select DVMT5.0 Total Graphic Memory size used by the Internal Graphics Device.

### Cd Clock Frequency

Select the highest Cd Clock frequency supported by the platform.

## 4.4.3 PEG Port Configuration (SA)

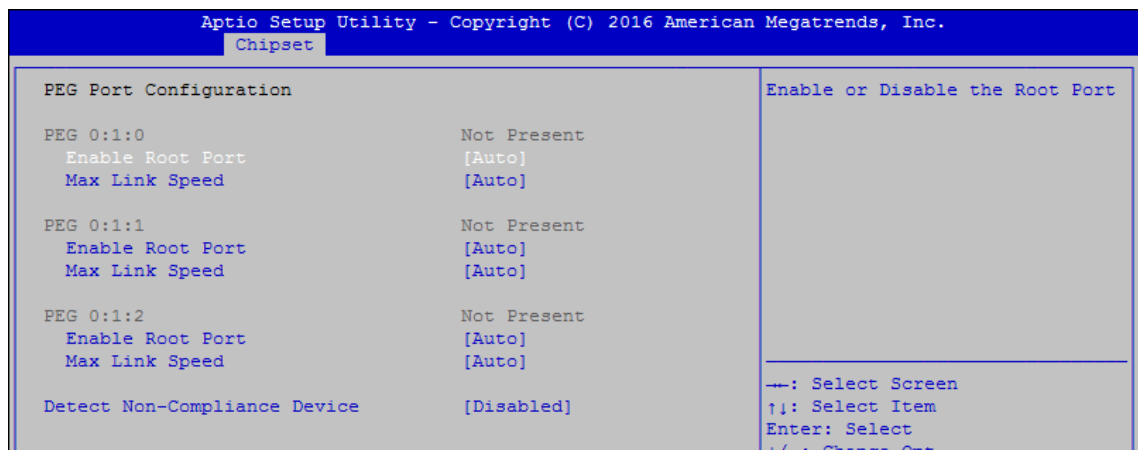

Figure 4-4-3: PEG Port Configuration

PEG port options for PCIe device.

#### 4.4.4 Memory Information of System Agent (SA)

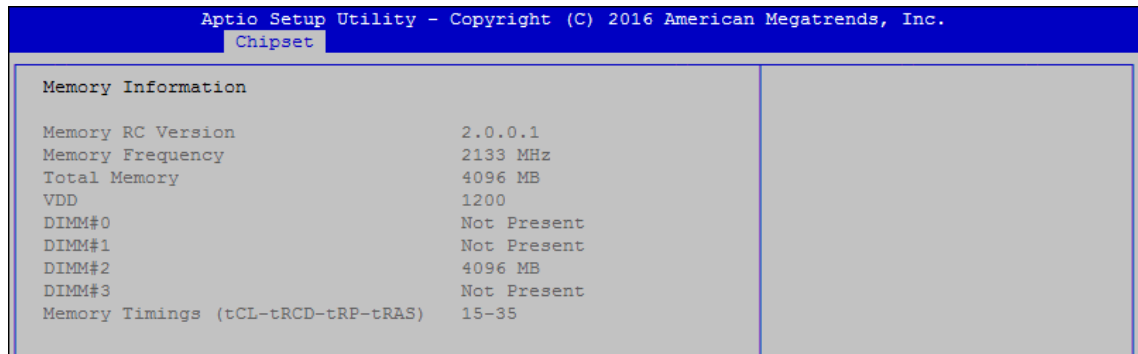

Figure 4-4-4: Memory Information

Displays memory information.

#### 4.4.5 PCH-IO Configuration

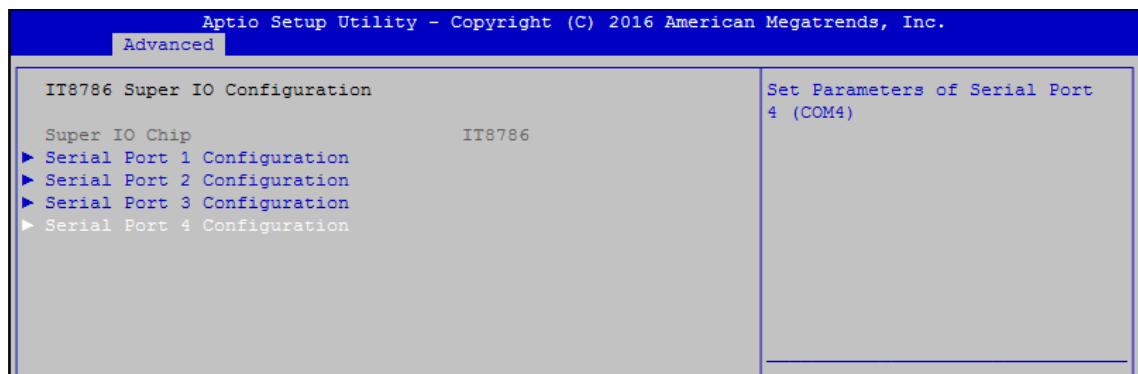

Figure 4-4-5: PCH-IO Settings

##### **PCH LAN Controller**

Enable or disable onboard NIC.

##### **Wake on LAN**

Enable or disable integrated LAN to wake the system. (The wake On LAN cannot be disabled if ME is on at Sx state.)

##### **Serial IRQ Mode**

Configure serial IRQ mode.

##### **State After G3**

Specify what state to go to when power is re-applied after a power failure (G3 state).

S0 State: Always turn-on the system when power source plugged-in.

S5 State: Always turn-off the system when power source plugged-in.

## 4.4.6 PCI Express Configuration of PCH-IO

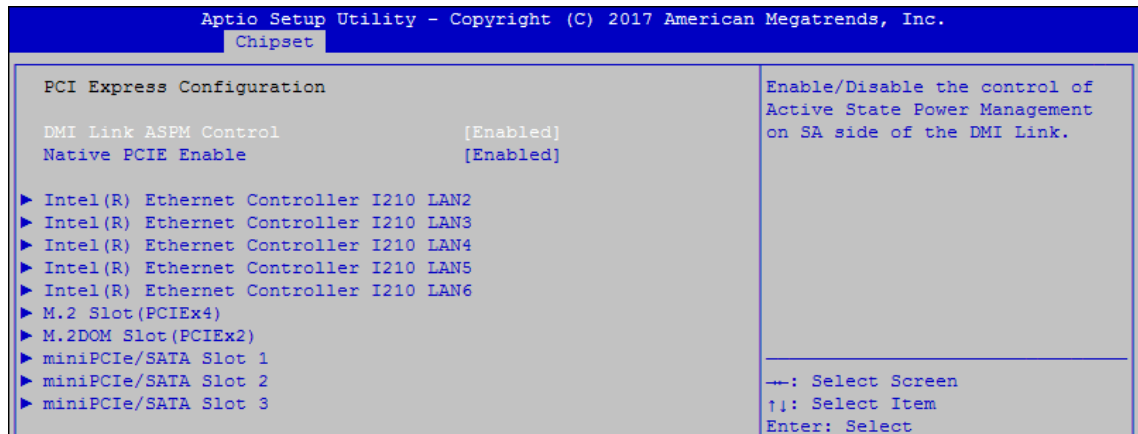

Figure 4-4-6: PCH-IO Settings

### DMI Link ASPM Control

Enable/Disable the control of Active State Power Management on SA side of the DMI Link.

### Native PCIE Enable

PCI Express Native Support Enable/Disable. This feature is available in vista and beyond Windows OS.

## 4.4.7 BIOS Security Configuration of PCH-IO

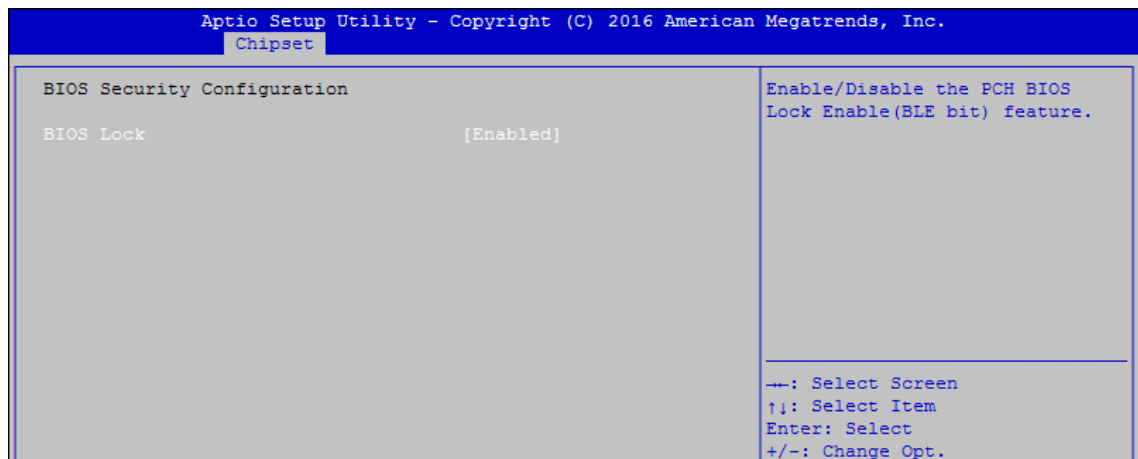

Figure 4-4-7: BIOS Security Settings

### BIOS Lock

Enable/disable the PCH BIOS Lock Enable (BLE bit) feature.

## 4.4.8 SB Porting Configuration of PCH-IO

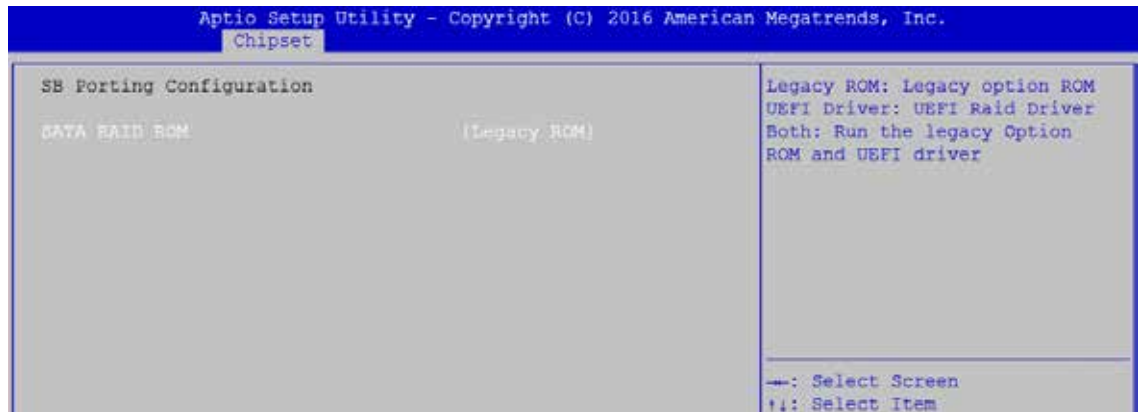

Figure 4-4-8: RAID ROM Settings

### SATA RAID ROM

Legacy ROM: Legacy option ROM

UEFI Driver: UEFI Raid Driver

Both: Run the Legacy Option ROM and UEFI driver.

## 4.4.9 GPIO Manager Configuration

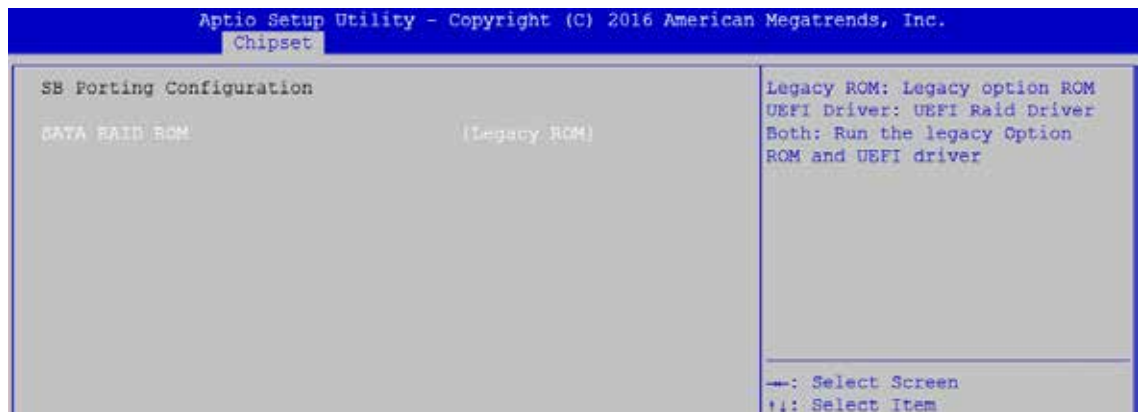

Figure 4-4-9: GPIO Manager Settings

### VGA Enable

Enable: VGA display output enabled

Disable: VGA display output disabled



## 4.5 Security

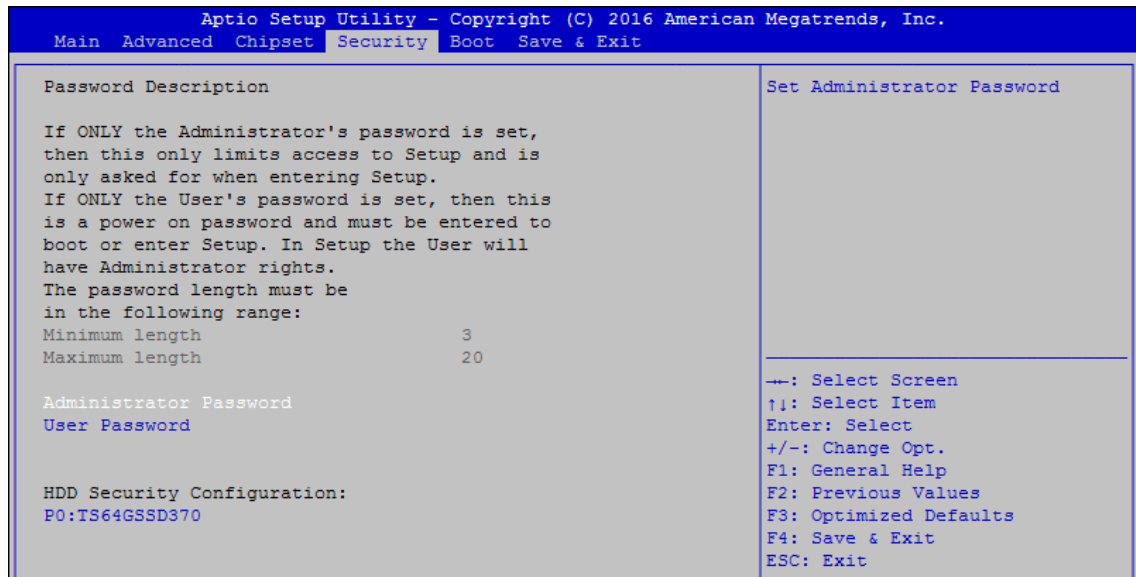

Figure 4-5: BIOS Security Menu

### Administrator Password

Set administrator password.

### User Password

Set user password.

### 4.5.1 HDD Security Configuration

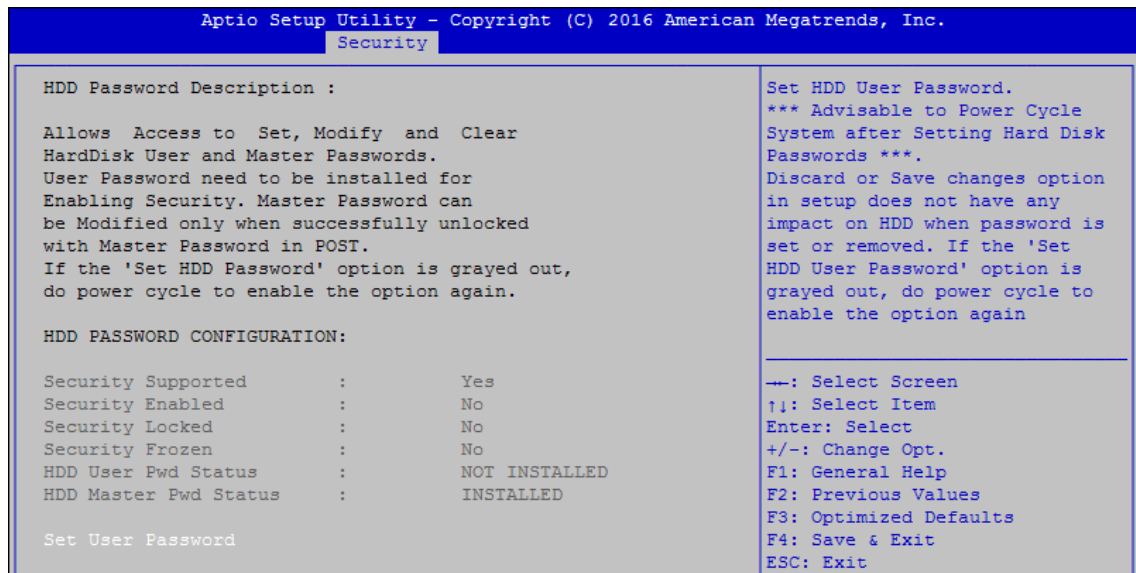

Figure 4-5-1: HDD Security Settings

### Set User Password

Set HDD user password.

\*\*\* Advisable to power cycle system after setting hard disk passwords \*\*\*

Discard or save changes option in setup does not have any impact on HDD when password is set or removed. If the 'Set HDD User Password' option is gray, do power cycle to enable the option again.

## 4.6 Boot

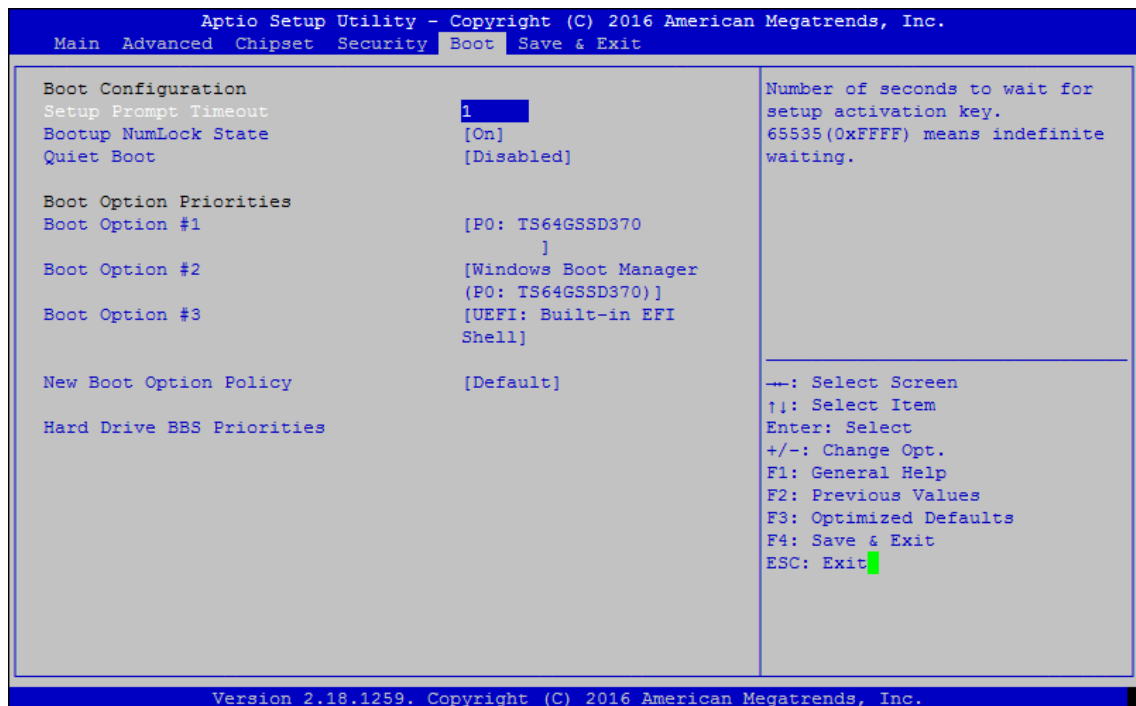

Figure 4-6: BIOS Boot Menu

### Setup Prompt Timeout

Number of seconds to wait for setup activation key. 65535(0xFFFF) means indefinite waiting.

### Bootup NumLock State

Select the keyboard NumLock state.

### Quiet Boot

Enables or disables Quiet Boot option.

### Boot Option

Sets the system boot order.

### New Boot Option Policy

Controls the placement of newly detected UEFI boot options.

### Hard Drive BBS Priorities

Set the order of the Legacy devices in this group.

## 4.7 Save & Exit

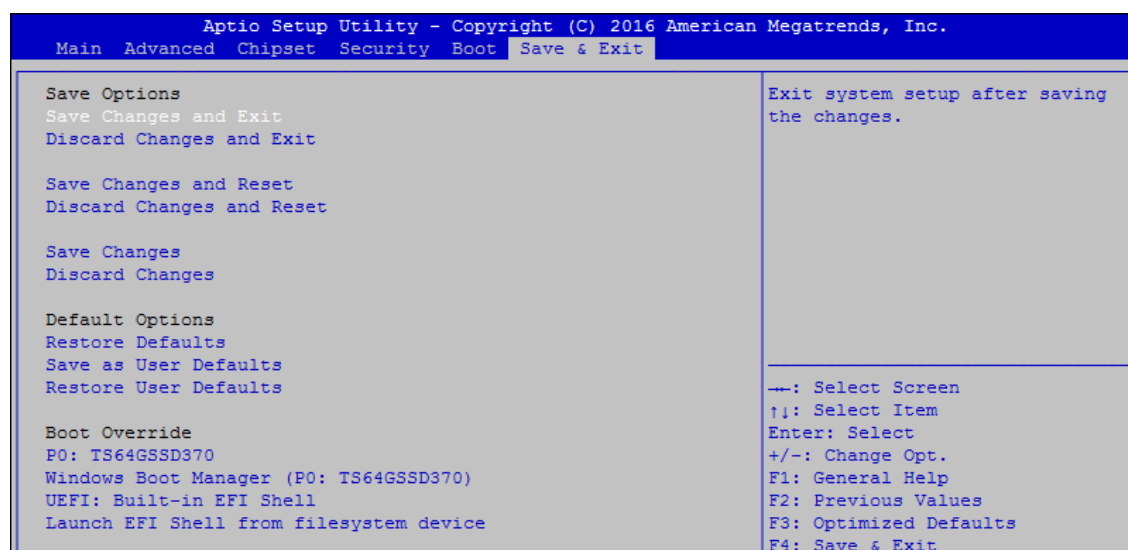

Figure 4-7: Bios Save and Exit Menu

### Save Changes and Exit

Exit system setup after saving the changes.

### Discard Changes and Exit

Exit system setup without saving any changes.

### Save Changes and Reset

Reset the system after saving the changes.

### Discard Changes and Reset

Reset system setup without saving any changes.

### Save Changes

Save changes done so far to any of the setup options.

### Discard Changes

Discard changes done so far to any of the setup options.

### Default Options:

#### Restore Defaults

Restore/load default values for all the setup options.

#### Save as User Defaults

Save the changes done so far as user defaults.

#### Restore User Defaults

Restore the user defaults to all the setup options.

# A

## APPENDIX A : Isolated DIO Guide

### A.1 Function Description

ECS-9200 GTX1050 offers two 16-bit DIO (Isolated / Non-Isolated) 20-pin terminal block connector, a watchdog timer, and a 4-port POE. Isolated DIO pins are fix by Hardware design that cannot change in / out direction in runtime process. DIO definition is shown below:

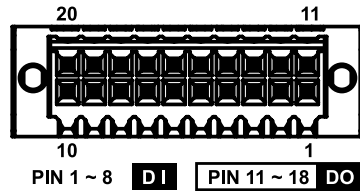

Pin No.	DIO Definition	GPIO Definition	Pin No.	DIO Definition	GPIO Definition
1	DIO	DIO0	11	DO0	DIO8
2	DI1	DIO1	12	DO1	DIO9
3	DI2	DIO2	13	DO2	DIO10
4	DI3	DIO3	14	DO3	DIO11
5	DI4	DIO4	15	DO4	DIO12
6	DI5	DIO5	16	DO5	DIO13
7	DI6	DIO6	17	DO6	DIO14
8	DI7	DIO7	18	DO7	DIO15
9	DI COM	NC	19	DIO GND	NC
10	DIO GND	NC	20	External VDC	NC

PoE definition is shown below:

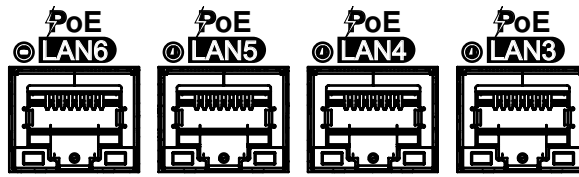

Port No.	Definition	Port No.	Definition
LAN 3	POE 0	LAN 5	POE 2
LAN 4	POE 1	LAN 6	POE 3

Do NOT use these functions in below:

1. PE-2000: DIO1 (ID = 0), POE
2. SE-1000: POE
3. UE-1000: USB (ID = 0)

## A.2 Isolated DIO Signal Circuit

DI reference circuit:

Sink Mode (NPN)

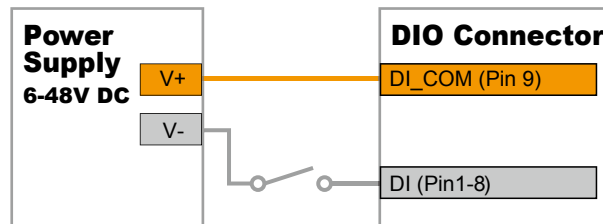

Source Mode (PNP)

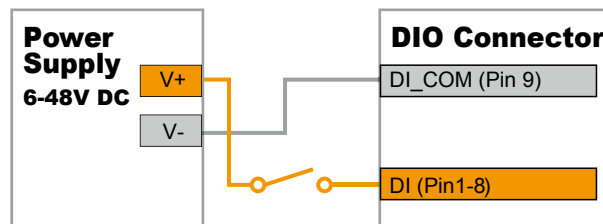

DO reference circuit:

Sink Mode  
(NPN, Default)

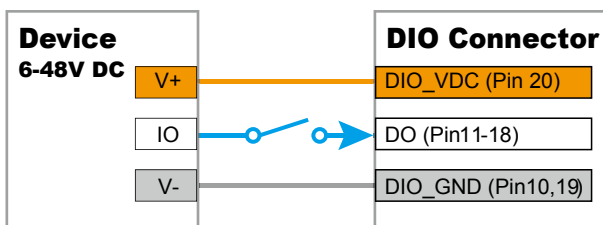

Source Mode  
(PNP)

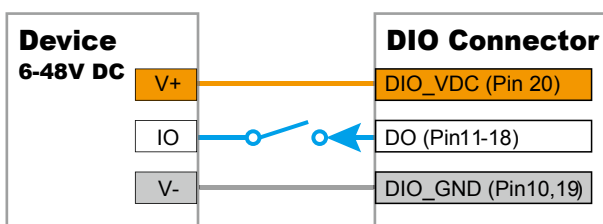

## A.3 Software Package Contain

Distribution folder include x32 and x64 versions, use batch file for installation.

There are included as followed:

Win7\_32.bat:

Installation for 32-bit driver

Win7\_64.bat:

Windows update package which driver required (need to restart), and Installation for 64-bit driver

Win8\_32.bat, Win8\_64.bat:

Installation for driver, and guideline to Framework 3.5 distribution for sample

Win10\_32.bat, and Win10\_64.bat:

Installation for driver, and installation to Framework 3.5 distribution for sample

Uninstall\_32.bat, and Uninstall\_64.bat:

Uninstallation for driver

Run batch file as Administrator.

Support Windows 7 above.

Make sure Windows version before installation.

Runtime folder include head file for software developer or System Integration.

Sample folder include sample program, driver library, and API library.

Source folder include sample program source code that compile on Visual Studio 2008.

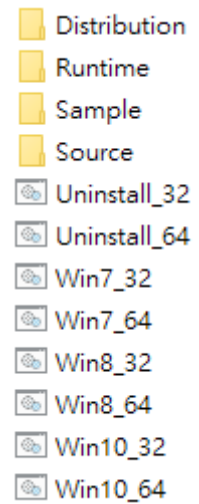



## A.4 Sample

Sample folder includes x32 and x64 versions, shown as below:



Sample ECS9K2.exe, shown as below:

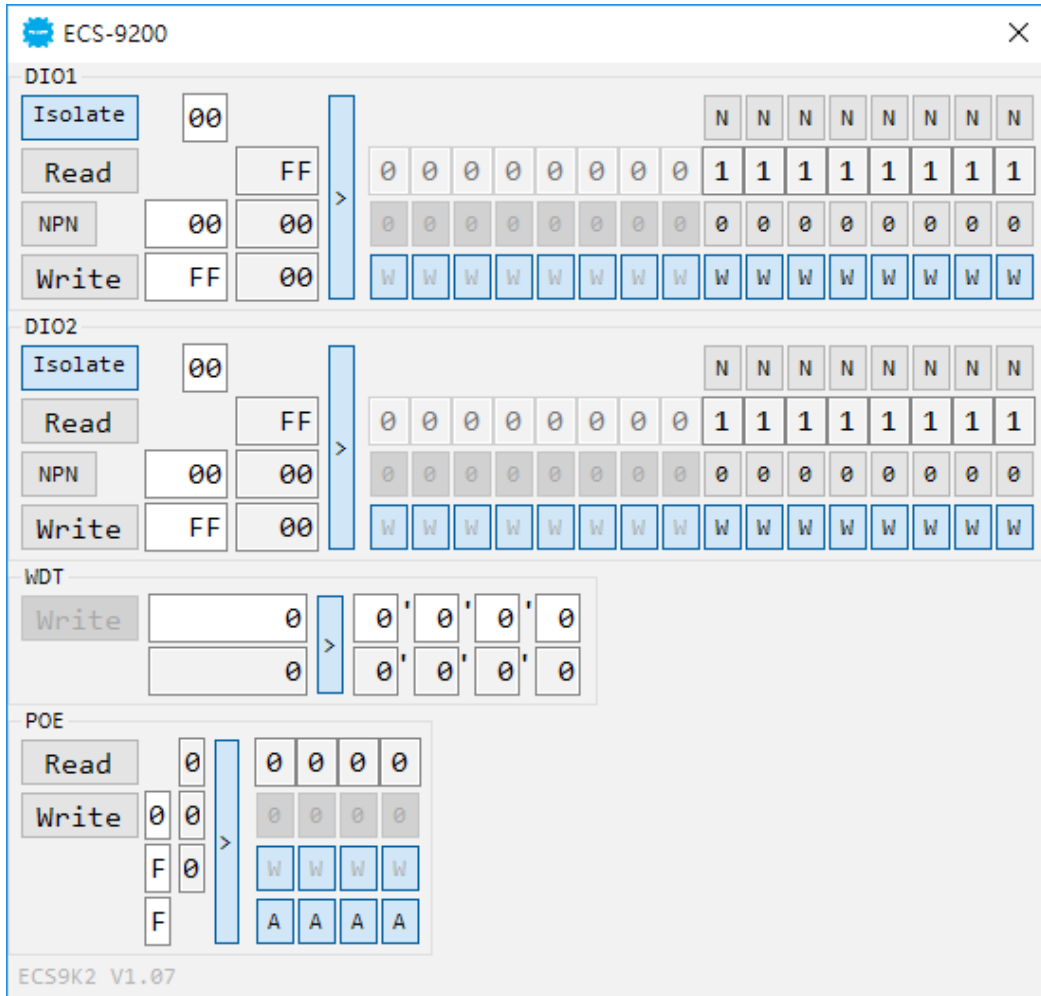

### **DIO1 / DIO2 group:**

Isolate check button:

DIO type of DIO configuration, isolated / non-isolated, defined in ECS-9000 series user manual.

Read button:

Set DIO configuration to get DI / DIO input state.

DO type check button:

User setting, DO type of DIO configuration to setup 8 pins - Source / Sink.  
Use for Write (DO) button activate.

Write button:

Set DIO configuration to set DO / DIO output state.

DI preference text:

User setting, DI type of DIO configuration by hexadecimal bitmask - Source / Sink.  
Use for Read (DI) button activate.

DO / DIO output text:

User setting, DO / DIO output state by hexadecimal bitmask - on / off.  
Use for Write button activate.

DO / DIO writable text:

User setting, DO / DIO writable of DIO configuration by hexadecimal bitmask - yes / no.  
Use for Read (DIO) / Write button activate.

DI / DIO input text (read only):

DI / DIO input state by hexadecimal bitmask – on /off.  
Use for Read button activate.

DO / DIO text (read only):

DO / DIO output state with input state (DIO) and configuration.  
Use for Write button activate.

DO / DIO output text (read only):

DO / DIO output state with configuration.  
Use for Write button activate.

DI type pin texts (pin 8 ~ pin 1):

User setting, DI pin type of DIO configuration - Source / Sink.

DI / DIO input pin texts (read only, pin 8 ~ pin 1 / pin 18 ~ pin 11, pin 8 ~ pin 1):

DI / DIO input pin state  
Use for Read button activate.

DO / DIO output pin texts (pin 18 ~ pin 11 / pin 18 ~ pin 11, pin 8 ~ pin 1):

User setting, DO / DIO output pin state  
Use for Write button activate.

DO / DIO pin writable texts (pin 18 ~ pin 11 / pin 18 ~ pin 11, pin 8 ~ pin 1):

User setting, DO / DIO pin writable of DIO configuration.  
Use for Read (DIO) / Write button activate.

### **WDT group:**

Write button:

Set WDT when WDT setup text is valid.

Stop button:

Cancel WDT and counting.  
Use after Write button action.

WDT setup text:

User setting, WDT value, unit: second.

Use for Write button activate.

WDT counting text (read only):

WDT counting by program timer after set WDT.

Shown after Write button action.

WDT setup day format texts (user setting):

User setting, WDT value, format: day'hour'minute'second.

WDT counting day format text (read only):

WDT counting, format: day'hour'minute'second.

### **POE group:**

Read button:

Set POE configuration to get POE state.

Write button:

Set POE configuration to set POE state.

POE output text:

User setting, POE output state by hexadecimal bitmask - on / off.

Use for Write button activate.

POE writable text:

User setting, POE writable of POE configuration by hexadecimal bitmask - yes / no.

Use for Write button activate.

POE mode text:

User setting, POE mode of POE configuration by hexadecimal bitmask - Auto / Manual.

Use for Write button activate.

POE input text (read only):

POE input state by hexadecimal bitmask - on / off.

Use for Read button activate.

POE text (read only):

POE output state with input state and configuration.

Use for Write button activate.

POE output text (read only):

POE output state with configuration.

Use for Write button activate.

POE input port texts (read only, port 4 ~ port 1):

POE input port state

Use for Read button activate.

POE output port texts (port 4 ~ port 1):

User setting, POE output port state

Use for Write button activate.

POE port writable texts (port 4 ~ port 1):

User setting, POE port writable of POE configuration.

Use for Write button activate.

POE port mode texts (port 4 ~ port 1):

User setting, POE port mode of POE configuration.

Use for Write button activate.

# B

## APPENDIX B : Software Functions

### B.1 Driver API Guide

In Runtime folder, on ECS9K2.h:

`_DLL_IMPORT_` definition is used on LoadLibrary API for ECS9K2.dll.

`ECS9K_EXPORTS` definition is used on ECS9K2.dll building.

Otherwise, that is used to compile with ECS9K2.lib.

#### **BOOL Initial(BYTE Isolate\_Type, BYTE DIO\_NPN)**

Initial machine for DIO, watchdog timer, and POE

Isolate\_Type: DIO type

1: Isolated DIO; 0: Non-Isolated DIO

DIO\_NPN: DI / DO type

1: PNP (Source) mode for European rule;

0: NPN (Sink) mode for Japanese rule

Return:

TRUE (1): Success;

FALSE (0): Fail (Driver not exists, or initial error (version is too old, or machine not match))

#### **BOOL GetDIO1Config(BYTE \*Isolate\_Type, BYTE \*DI\_NPN, WORD \*Mask)**

#### **BOOL GetDIO2Config(BYTE \*Isolate\_Type, BYTE \*DI\_NPN, WORD \*Mask)**

Get DIO configuration (by variable)

Isolate\_Type: DIO type

1: Isolated DIO; 0: Non-Isolated DIO

DI\_NPN ([7:0]): DI type, pin setting by hexadecimal bitmask

1: PNP (Source) mode for European rule;

0: NPN (Sink) mode for Japanese rule

DO\_NPN: DO type

1: PNP (Source) mode for European rule;

0: NPN (Sink) mode for Japanese rule

Mask ([15:0]): In / Out, pin setting by hexadecimal bitmask

1: Output; 0: Input

Return:

TRUE (1): Success;

FALSE (0): Fail (Initial error, or call by pointer error, or hardware problem)

**BOOL SetDIO1Config(BYTE \*Isolate\_Type, BYTE \*DI\_NPN, BYTE \*DO\_NPN, WORD \*Mask)**

**BOOL SetDIO2Config(BYTE \*Isolate\_Type, BYTE \*DI\_NPN, BYTE \*DO\_NPN, WORD \*Mask)**

Set DIO configuration

Isolate\_Type: DIO type

1: Isolated DIO; 0: Non-Isolated DIO

DI\_NPN ([7:0]): DI type, pin setting by hexadecimal bitmask

1: PNP (Source) mode for European rule;

0: NPN (Sink) mode for Japanese rule

DO\_NPN: DO type

1: PNP (Source) mode for European rule;

0: NPN (Sink) mode for Japanese rule

Mask ([15:0]): In / Out, pin setting by hexadecimal bitmask

1: Output; 0: Input

Return:

TRUE (1): Success;

FALSE (0): Fail (Initial error, or hardware problem)

**BOOL GetDI1(BYTE \*DI)**

**BOOL GetDI2(BYTE \*DI)**

Get isolated DIO input (DI)

DI ([7:0]): Input state, pin setting by hexadecimal bitmask

1: High; 0: Low

Return:

TRUE (1): Success;

FALSE (0): Fail (Initial error, or call by pointer error, or hardware problem)

**BOOL GetDO1(BYTE \*DO)**

**BOOL GetDO2(BYTE \*DO)**

Get isolated DIO output (DO)

DO ([7:0]): Output state, pin setting by hexadecimal bitmask

1: High; 0: Low

Return:

TRUE (1): Success;

FALSE (0): Fail (Initial error, or call by pointer error, or hardware problem)

**BOOL SetDO1(BYTE DO)**

**BOOL SetDO2(BYTE DO)**

Set isolated DIO output (DO)

DO ([7:0]): Output state, pin setting by hexadecimal bitmask

1: High; 0: Low

Return:

TRUE (1): Success;

FALSE (0): Fail (Initial error, or hardware problem)

**BOOL GetDIO1(WORD \*DI)****BOOL GetDIO2(WORD \*DI)**

Get non-isolated DIO input (DIO input)

DI ([15:0]): Input state, pin setting by hexadecimal bitmask

1: High; 0: Low

Return:

TRUE (1): Success;

FALSE (0): Fail (Initial error, or call by pointer error, or hardware problem)

**BOOL SetDIO1(WORD DO)****BOOL SetDIO2(WORD DO)**

Set non-isolated DIO output (DIO output)

DO ([15:0]): output state, pin setting by hexadecimal bitmask

1: High; 0: Low

Return:

TRUE (1): Success;

FALSE (0): Fail (Initial error, or hardware problem)

**BOOL GetWDT(DWORD \*WDT)**

Get watchdog timer setup

WDT: watchdog timer setup

Unit: second. (Range: 0 ~ 65535 sec, 1093 ~ 65535 min  
(=65580 ~ 3932100 sec))

Return:

TRUE (1): Success;

FALSE (0): Fail (Initial error, or call by pointer error, or hardware problem)

**BOOL SetWDT(DWORD WDT)**

Set watchdog timer setup

WDT: watchdog timer setup

Unit: second. (Range: 1 ~ 65535 sec, 1093 ~ 65535 min  
(=65580 ~ 3932100 sec))

Return:

TRUE (1): Success;

FALSE (0): Fail (Initial error, or setup 0 error, or hardware problem)

**BOOL CancelWDT()**

Cancel watchdog timer

Return:

TRUE (1): Success;

FALSE (0): Fail (Initial error, or hardware problem)

**BOOL GetPOEConfig(BYTE \*Auto, BYTE \*Mask)**

Get POE configuration (by variable)

Auto ([3:0]): Auto mode, pin setting by hexadecimal bitmask

1: Auto; 0: Manual

Mask ([3:0]): DC Enable / Disable, pin setting by hexadecimal bitmask



1: Enable; 0: Disable

Return:

TRUE (1): Success;

FALSE (0): Fail (Initial error, or call by pointer error, or hardware problem)

### **BOOL SetPOEConfig(BYTE Auto, BYTE Mask)**

Set POE configuration

Auto ([3:0]): Auto mode, pin setting by hexadecimal bitmask

1: Auto; 0: Manual

Mask ([3:0]): DC Enable / Disable, pin setting by hexadecimal bitmask

1: Enable; 0: Disable

Return:

TRUE (1): Success;

FALSE (0): Fail (Initial error, or out of range error, or hardware problem)

### **BOOL GetPOE(BYTE \*POE)**

Get POE input

POE ([3:0]): POE state, pin setting by hexadecimal bitmask

1: On; 0: Off

Return:

TRUE (1): Success;

FALSE (0): Fail (Initial error, or call by pointer error, or hardware problem)

### **BOOL SetPOE(BYTE POE)**

Set POE output

POE ([3:0]): POE state, pin setting by hexadecimal bitmask

1: On; 0: Off

Return:

TRUE (1): Success;

FALSE (0): Fail (Initial error, or out of range error, or hardware problem)

# C

## APPENDIX C : RAID Installation Guide

### C.1 SATA Mode for RAID

Please select SATA device to RAID mode on BIOS menu.  
Advanced → SATA Configuration → SATA Mode Selection

Main	Advanced	Chipset	Boo	Security	Save & Exit	
SATA Controller(s)					[Enabled]	Item Specific Help
SATA Model Selection					[AHCI]	

### C.2 OS Installation

ECS-9200/9100 GTX1050 is featured with six SATA, include two internal SATA, three mSATA and one CFAST.

You can select one of SATA ports for OS installation

We used CFAST card for Windows 10 OS installation as an example.

### C.3 Install Device Drivers

The instructions are as follows:

1. Install Chipset driver
2. Install Graphic driver
3. Install Network driver
4. Install ME driver (if available)
5. Install Audio driver

## C.4 Install “Intel Rapid Storage Technology” Software

You can get the software on ECS-9200/9100 GTX1050 driver CD.  
Also, you can find latest information and software directly from Intel website.

[http://www.intel.com/p/en\\_US/support/highlights/chpsts/ismm](http://www.intel.com/p/en_US/support/highlights/chpsts/ismm)

The RAID environment has been done if you completed the steps above.

## C.5 Insert SATA HDD for RAID 1

Please notice, you can use six SATA ports for SATA HDD, except for the CFast port and mSATA slot.

## C.6 Create RAID Volume

ECS-9200/9100 GTX1050 is featured with four SATA HDDs for RAID volume, so there are three options for choose on this page. Let’s take RAID 1 as example, please select “RAID 1”.



## C.7 Disk Management : Partition the Disk

After RAID 1 volume created, you can see the figure of SATA device allocation.

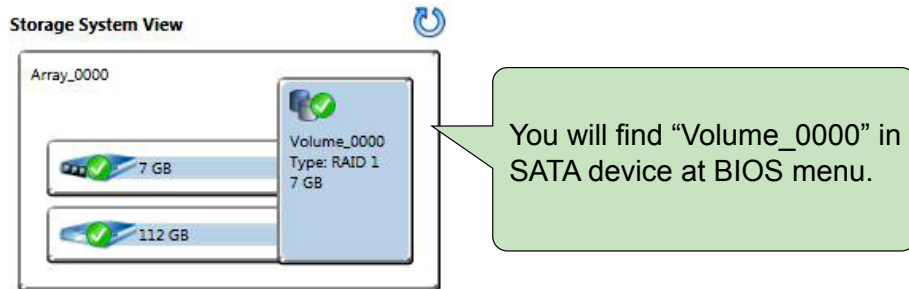

To start Disk Management tool, select "initialize disk."

Then add "Logical Device" for Windows access.

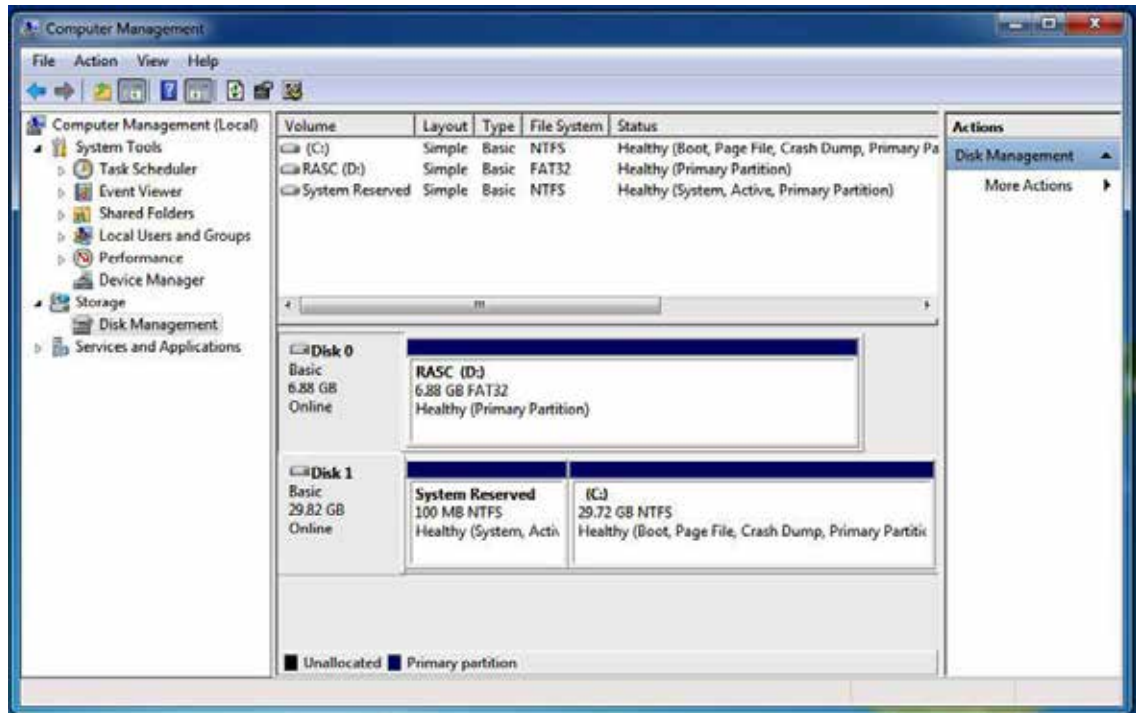

## C.8 RAID HDD Fail

After RAID 1 volume created, you can see the figure of SATA device allocation.

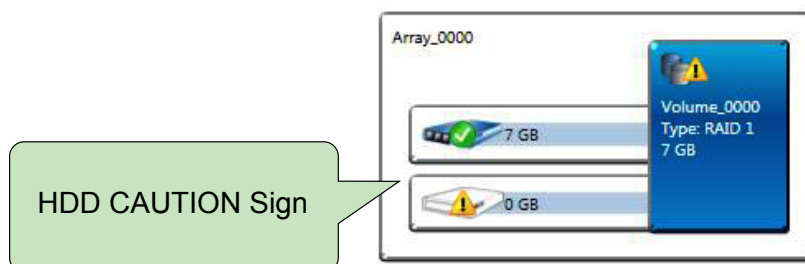

## C.9 Original HDD Recovery

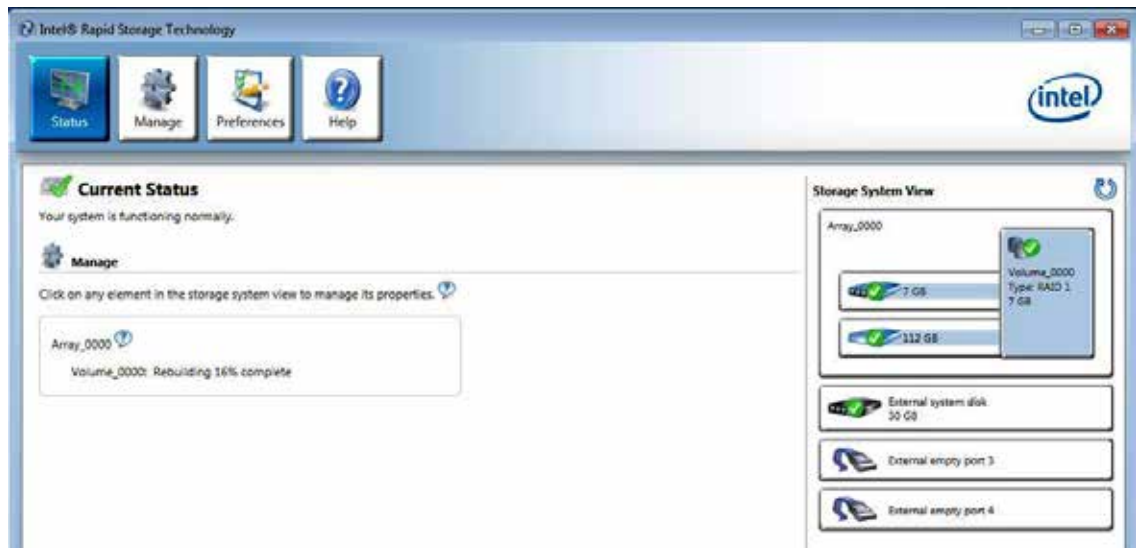

## C.10 New HDD Recovery

There is a warning will pop-up to ask you if the disk is not a member of original RAID volume.

If you press “Rebuild”, it will replace the broken SATA HDD to the last one SATA HDD of RAID volume.

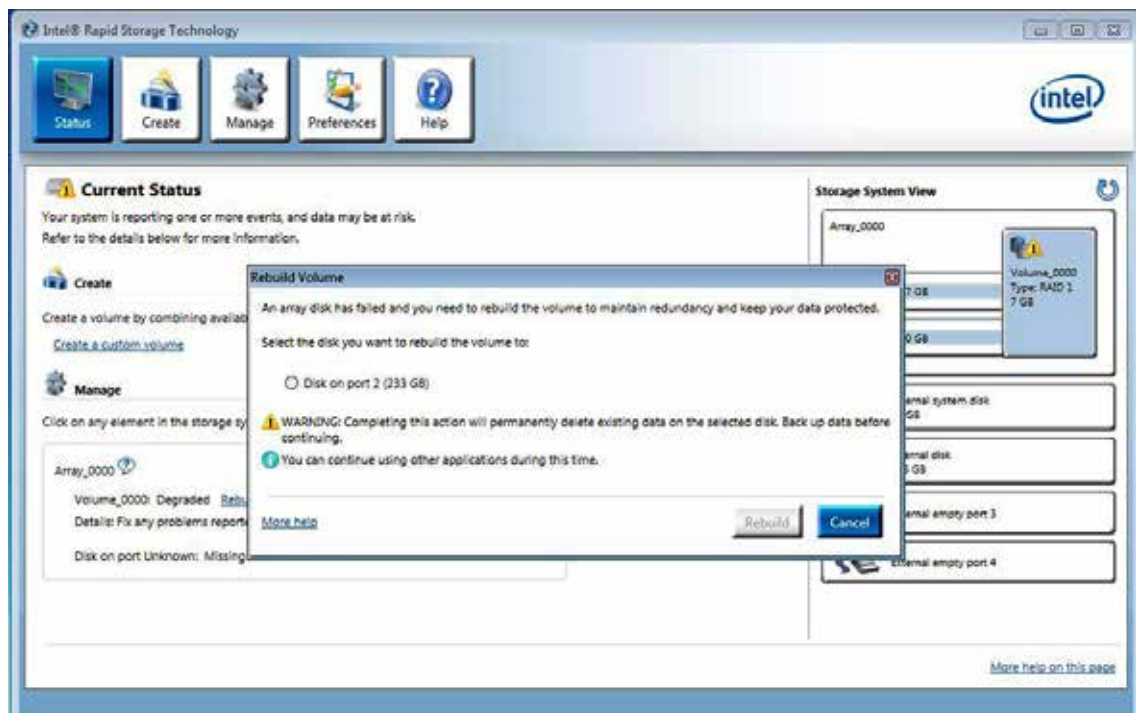

# D

## APPENDIX D : Power Consumption

Testing Board	ECS-9200 GTX1050
RAM	8GB X 2
USB-1	USB Keyboard Logitech K120
USB-2	USB Mouse Microsoft 1113
USB-3	USB Flash Transecnd 3.0 8GB
USB-4	USB Flash Transecnd 3.0 8GB
CFAST	innodisk CFast 3ME3 64GB
SATA 0	MEMXPRO M3A 256GB
SATA 1	TOSHIBA SSD THNS064GE4BBDC 64GB
LAN 1 (i219)	1.0 Gbps
LAN 2 (i210)	1.0 Gbps
LAN3 (i210)	1.0 Gbps
LAN4 (i210)	1.0 Gbps
LAN5 (i210)	1.0 Gbps
LAN6 (i210)	1.0 Gbps
Graphics Output	DVI
Power Plan	Balance (Windows10 Power Plan)
Power Source	Chroma 62006P-100-25



## D.1 Intel® Core™ i7-6700 (8M Cache, up to 4.00 GHz)

### Power on and boot to Win 10 64-bit

CPU	Power Input	Sleep Mode		Idle Status : CPU usage less 3%	
		Max Current	Max Consumption	Max Current	Max Consumption
Core™ i7-6700	15V	0.324A	04.86W	1.810A	27.15W
Core™ i7-6700	24V	0.276A	06.62W	1.172A	28.13W
Core™ i7-6700	36V	0.237A	08.53W	0.852A	30.67W

CPU	Power Input	Run 100% CPU usage without 3D		Run 100% CPU usage with 3D	
		Max Current	Max Consumption	Max Current	Max Consumption
Core™ i7-6700	15V	4.066A	60.99W	7.339A	110.09W
Core™ i7-6700	24V	2.569A	61.66W	4.648A	111.55W
Core™ i7-6700	36V	1.768A	63.65W	3.158A	113.69W

# E

## APPENDIX E : Supported Memory & Storage List

### E.1 Supported Memory List

Testing Board	ECS-9200 GTX1050
Memory Test	version: 5.1
BurnInTest	V8.1

### E.2 Test Item

Channel	Memory Test	Burn In	Flash BIOS	Remove Battery
*2	PASS	PASS	PASS	PASS
*1(Socket 1)	PASS	PASS	N/A	PASS
*1(Socket 2)	PASS	PASS	N/A	PASS

## E.3 NON-ECC

Brand	Info	NOTE & S\N	Test Temp. (Celsius)
Kingston 16GB 2Rx8 2Gx64-Bit PC4-2133	KVR21S15D8/16	BKMM1641607	25°C
		BKMM1661618	25°C
Memxpro 4GB DDR4-2133-15 Wild Temp.	D4S4GHIOFEI	01611170040001	25°C
		01611170040002	25°C
Memxpro 8GB DDR4-2133-15 Wild Temp.	D4S8GHIOFFI	01611150020001	25°C
		01611150020002	25°C
Memxpro 8GB DDR4-2400-17- Wild Temp.	D4S8GHLPGEI	01611170030001	25°C
		01611170030002	25°C
Memxpro 16GB DDR4-2400-17 Wild Temp.	D4SAGHLPGFI	01611150030001	85°C
		01611150030002	85°C
Memxpro 16GB DDR4-2400-17	D4SAGHLPGFC	01611150030003	25°C
		01611150030004	25°C
Memxpro 8GB DDR4-2400-17	D4S8GHLPGEC	01611170030003	25°C
		01611170030004	25°C
Memxpro 8GB DDR4-2133-15	D4S8GHIOFFC	01611150020003	25°C
		01611150020004	25°C
Memxpro 4GB DDR4-2133-15	D4S4GHIOFEC	01611170040003	25°C
		01611170040004	25°C
Apacer 8GB DDR4-2400 Wild Temp.	75.CA4GJ.G010B	201646411081	25°C
Apacer 16GB DDR4-2400 Wild Temp.	75.DA4GJ.G010B	201646411074	25°C

## E.4 ECC

Brand	Info	NOTE & S\N	Test Temp. (Celsius)
Transcend 8GB ECC Wild Temp.	8G 2Rx8 DDR4 2133 ECCSO	C96644-0001	85°C
		C96644-0002	85°C

## E.5 Supported Storage Device List

Type	Brand	Model	Capacity
mSATA	Intel	Intel-310 SSDMAEMC080G2	80GB
	Silicon Power	SP128GIMSA301SW0	128GB
SATA SSD	Transcend	SSD370 TS64GSSD370	64GB
	Memxpro	SSD M3A MI3MA1212802WN	128GB
		SSD M3A MI3MA1225604WN	256GB
		SSD M3A MI3MA1251208WN	512GB
	Innodisk	3MR3-P DRS25-64GD70BCAQC	64GB
Silicon Power	SP128GISSD301RW0	128GB	
SATA HDD	TOSHIBA	MK5055GSX	500GB
M.2 SATA SSD	Memxpro	M3B MD3MB1164GS1WN	64GB
		M3B MD3MB1164GS1SN	64GB
		M3B MD3MB11128D2WN	128GB
		M3B MD3MB11128D2SN	128GB
		M3B MP3MB12256S4WN	256GB
		M3B MP3MB12256S4SN	256GB
M.2 PCIe	Memxpro	ME4ME01128D4SN-M0	128GB
		ME4AE02128D4SNR	128GB
CFast	Transcend	CFX600	32GB
	Silicon Power	SP128GICFX311NV0	128GB

# F

## APPENDIX F : Graphics Performance

Test Temperature (based on 95% Humidity)	30°C	35°C	40°C	45°C	50°C	55°C	60°C
3DMARK 11 (V1.5.5.0)							
Resolution	1920 x 1080						
Score	X3074	X3056	X3026	X2935	X2782	X2590	X2570
Highest Temperature	70°C	73°C	79°C	83°C	83°C	86°C	90°C
Power Status							
On	PASS	PASS	PASS	PASS	PASS	PASS	PASS
Off	PASS	PASS	PASS	PASS	PASS	PASS	PASS

### Testing Equipment

CPU : Intel® Core™ i7-6700

IMB : ECS-9200

Memory : MEMXPRO 8GB\*2

\*\* If more help is needed, please contact Vecow technical support \*\*



For further support information, please visit [www.vecow.com](http://www.vecow.com)

This document is released for reference purpose only.

All product offerings and specifications are subject to change without prior notice.

No part of this publication may be reproduced in any form or by any means, electric, photocopying, or recording, without prior authorization from the publisher.

The rights of all the brand names, product names, and trademarks belong to their respective owners.

© Vecow Co., Ltd. 2017. All rights reserved.