

User Manual

Monitor
DF24N1S

DEXP

Contents

Intended Use	3
Safety Precautions	3
Assembly and Placement	4
Monitor Placement	4
Assembly.....	5
Screen Position Adjustment.....	6
VESA Mount Specifications	6
Specifications	7
Device Diagram	8
Interface.....	8
Operating Instructions	8
Monitor Connection.....	8
Control Buttons	9
Power Indicator Status.....	9
Cleaning and Maintenance	9
Troubleshooting Guide	9
Rules and Conditions for Installation, Storage, Transportation, Sale (Distribution), and Disposal	10
Warranty Information	11
Additional Information	11

Dear Customer,

Thank you for choosing our products.

We are pleased to offer you appliances and devices designed and manufactured to the highest standards of quality, functionality, and design. Before using the device, please read this manual carefully. It contains important information regarding your safety, as well as recommendations for the proper use and care of the product. Please keep this manual in a safe place and use it as a reference guide during future operation of the product.

Intended Use

The monitor is designed to display information from a personal computer.

Safety Precautions

- Use only appropriate types of power outlets. Before connecting the device to the power source, ensure that the voltage of your household electrical network matches its technical specifications.
- Place the device only on flat, stable surfaces.
- Avoid using the monitor near devices that generate magnetic fields (e.g., electric motors, televisions, etc.).
- Do not place heavy objects on the video cable or power cord, and protect them from physical damage (such as pinching, cutting, kinking, or twisting). Do not route the cables in areas where they may be accidentally tripped over or pulled by people or pets.
- Do not touch the power cord with wet hands.
- Position the monitor in a location that avoids reflections and glare on the screen.
- Do not block the ventilation openings on the back and bottom of the monitor or insert any objects into them.
- Protect the device from moisture, dust, and extreme temperatures.
- Always disconnect the device from the power source before cleaning or during an extended period of non-use.
- Immediately unplug the monitor from the power source in case of malfunction. Do not operate the device if it shows visible signs of damage, or if the power cord is damaged. Contact an authorized service center.
- If unusual sounds or odors occur, immediately disconnect the monitor from the power source and contact an authorized service center.
- Do not remove the cover or the back panel of the monitor. This may cause electric shock or fire. There are no user-serviceable parts inside. Servicing must be performed exclusively by qualified technical personnel at an authorized service center.
- This device is not intended for commercial use.
- This device is not intended for use by persons (including children) with reduced physical, sensory or mental capabilities, or lack of experience and knowledge, unless they have been given supervision or instruction concerning use of appliance by a person responsible for their safety. Children should be supervised to ensure that they do not play with the device.

Assembly and Placement

Monitor Placement

- Protect the device from direct sunlight.
- Install the monitor only in a well-ventilated area.
- Do not place heavy objects on top of the monitor.
- Place the monitor in a dry, dust-free location.
- Do not install the monitor near sources of magnetic fields (such as audio systems, televisions, and other devices).

Note: All images are for illustrative purposes only and may differ from the actual product.

Wall mounting

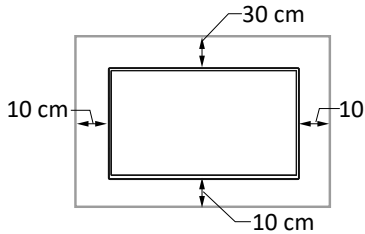

Stand placement

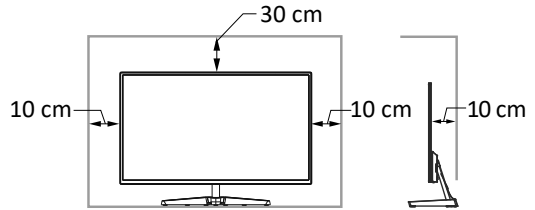

Air circulation obstruction

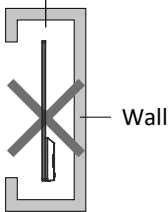

Air circulation obstruction

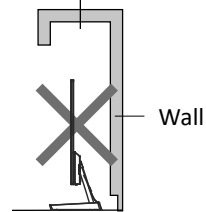

Assembly

Attaching the Stand

Join the stand parts together with a screw and tighten using a screwdriver. Insert the assembled stand into the designated slot on the back of the monitor until it clicks into place.

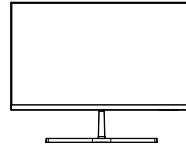
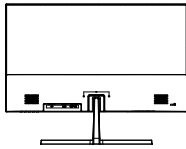
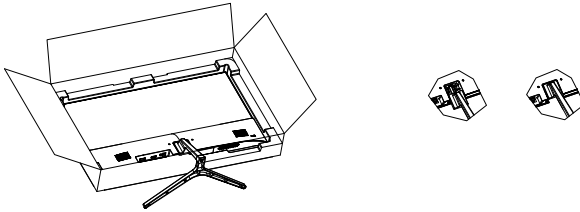
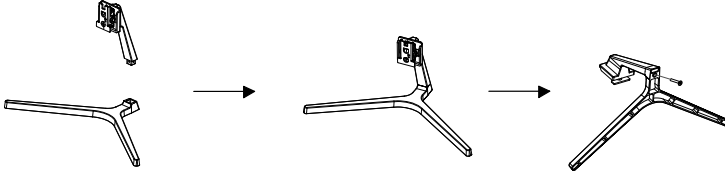

Removing the Stand

Perform the above steps in reverse order.

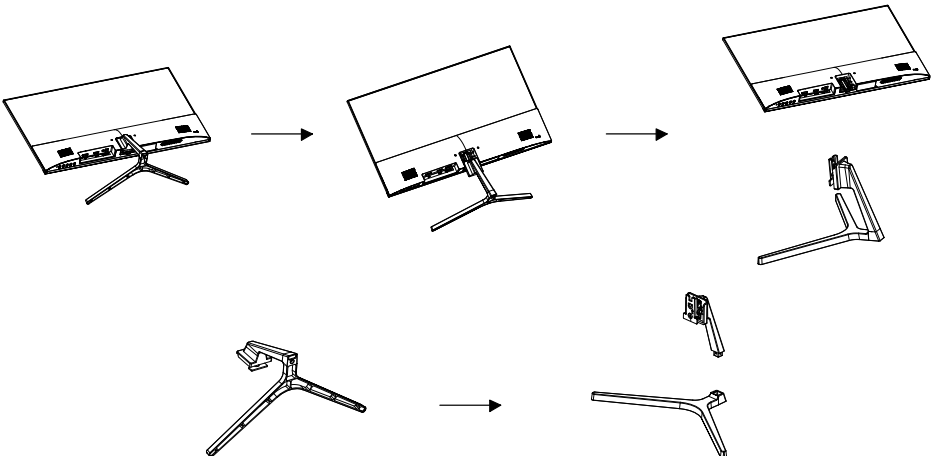

Screen Position Adjustment

The monitor allows you to adjust the screen position for maximum comfort during use. You can tilt the screen 5° forward or 15° backward. When adjusting the tilt angle, do not touch the screen under any circumstances to avoid damaging or soiling its surface.



CAUTION:

Do not apply excessive force when adjusting the tilt angle.

VESA Mount Specifications

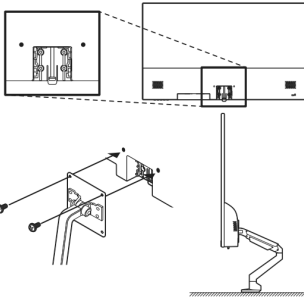

VESA Mount Standard — 75 × 75 mm.

Attach the mounting bracket to the back of the monitor using two M4 screws, as shown in the figure on the left.

Notes

- Do not use screws that are longer than the standard length or screws that do not comply with VESA standards, as they may cause damage to internal components.
- Installing a wall mount bracket other than the specified one may be difficult.
- Do not overtighten the screws. This may damage the monitor and cause it to fall.
- The wall mount and screws are not included.

Specifications

Model	DF24N1S
Trademark	DEXP
Power supply	Input: 100–240 V ~ 50–60 Hz, 1,2 A Output: 12 V = 2,5 A, 30 W
IP code	IP20
Protection class	III
Screen size	23,8"
Luminance (cd/m²)	250
Colors	16,7 million
Panel technology	IPS
Aspect ratio	16:9
Contrast ratio	1000:1
Maximum resolution	1920 × 1080
Refresh Rate	100 Hz
Interface	HDMI, VGA, Audio
Response time (GtG)	5 ms
Response time (MPRT)	5 ms
Viewing angle	Horizontal — 178° Vertical — 178°
Speaker power	2 × 1 W
Power consumption in standby mode	≤ 0,5 W
Power consumption in operating mode	30 W
VESA Mount Standard	75 × 75
Net weight	2,68 kg
Cord type	X (detachable)
Scope of application	Domestic
Package contents	Monitor, power adapter, HDMI cable, cable clip, screen cleaning cloth, screwdriver, stand, assembly screw, user manual.

Device Diagram

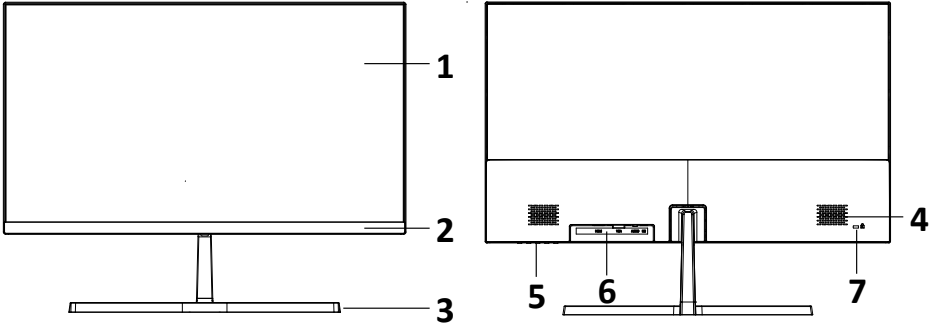

- 1. Screen.
- 2. Frame.
- 3. Stand.
- 4. Speaker.
- 5. Control buttons.
- 6. Interface.
- 7. Kensington security lock slot.

Interface

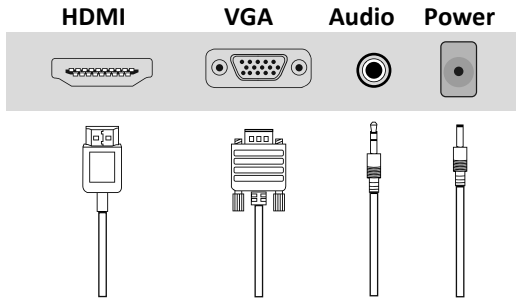

Operating Instructions

Monitor Connection

- Ensure that both the monitor and the PC are disconnected from the power source.
- Connect the signal cable connector to the corresponding port on the monitor, and the other end to the graphics card port on your computer.
- To connect the monitor to a grounded power source, plug the power cord connector into the corresponding port on the monitor.
- Set the resolution and refresh rate in the "Screen Resolution" tab (for Windows OS).

Control Buttons

- MENU — press to display the on-screen menu / select option.
- DOWN — navigate down / decrease value.
- UP — navigate up / increase value.
- EXIT — return to previous menu / auto-adjust.
-  — turn the monitor on/off.

Power Indicator Status

- Off — The monitor is turned off.
- Solid — The monitor is connected to a signal source.
- Flashing — The monitor is turned on, but no signal is detected.

Cleaning and Maintenance

To clean the screen, use only a soft, dry cloth. Do not use any liquids or chemical cleaning agents.

Troubleshooting Guide

The monitor does not turn on / No power	Check the power connection Ensure the power cord is securely connected
	Check if the power cord is damaged. Replace it if necessary
The monitor is overheating	When installing the monitor, maintain the clearances specified in the «Monitor Placement» section of this manual to ensure adequate air circulation around the device
Dark/bright spots on the display when powering on	This is normal. This effect is caused by uneven backlight illumination during startup due to temperature differences. The dark/bright spots will disappear after the monitor has been operating for 20 minutes
Vertical and horizontal lines on the display	Set a refresh rate that is supported by the monitor on your PC
Power is supplied, but no image appears	Ensure the cables are securely connected
	Check the graphics card connection
	Check for damage to the monitor ports and cable connectors
	Adjust brightness and contrast
Color distortion / Black and white image	Make sure the monitor port and video cable connector are not damaged. Replace the cable if necessary
	Ensure that the graphics card is firmly seated in the motherboard slot
	Adjust brightness and contrast

CAUTION: If the above solutions do not resolve the issue, discontinue use of the monitor and contact an authorized service center.

Rules and Conditions for Installation, Storage, Transportation, Sale (Distribution), and Disposal

- The installation and mounting conditions for the device are described in the “Assembly and Placement ” section of this user manual.
- The device must be stored in its original packaging, on heated premises, both at the manufacturer’s and at the consumer’s sites. The ambient temperature should be between +5 °C and +40 °C, and the relative humidity should not exceed 80% (non-condensing). The storage area must be free from aggressive contaminants (e.g., acid or alkali vapors) that could cause corrosion.
- The device must be transported in a dry place.
- The device requires careful handling. Protect it from exposure to dust, dirt, impact, moisture, fire, and other hazards.
- Sale or distribution of the device must be carried out in accordance with local legislation.
- Upon expiration of the device’s service life, it must not be disposed of with unsorted household waste. Instead, it must be taken to an authorized collection point for electrical and electronic equipment for subsequent recycling and disposal in accordance with federal or local legislation. By ensuring proper disposal of this product, you help conserve natural resources and prevent potential harm to the environment and human health that may result from improper handling. For more detailed information about collection and disposal points for this product, please contact your local municipal authorities or your household waste disposal service.
- If a device malfunction is detected, immediately contact an authorized service center or dispose of the device.

Warranty Information

The manufacturer guarantees the device will function properly throughout the warranty period and be free from defects in materials and assembly. The warranty period commences on the date of purchase and applies to new products only. Warranty service includes free repair or replacement of defective parts that fail during the warranty period, provided the failure is not caused by consumer misuse and the product is operated in accordance with the user manual. Repairs or part replacements shall be performed at authorized service centers.

Warranty Period: 36 months.

Service Life: 48 months.

For the up-to-date list of authorized service centers, please visit: <https://www.dns-shop.ru/service-center/>

Additional Information

Manufacturer: Yibin Jiaxin Electronic Technology Co., Ltd.
No.136, West Section of Xinggong Road, Lingang Economic Development Zone, Yibin City, Sichuan Province, China.

Made in China.

The product meets the requirements of the CU TR (EAEU).

Product specifications, information and appearance are subject to change without prior notice, for quality improvement of our products.

HDMI[®]
HIGH-DEFINITION MULTIMEDIA INTERFACE



EAC

Production date (mm.yyyy): _____ V.1

