

ZALMAN

ATX MID TOWER COMPUTER CASE
Z9 NEO PLUS

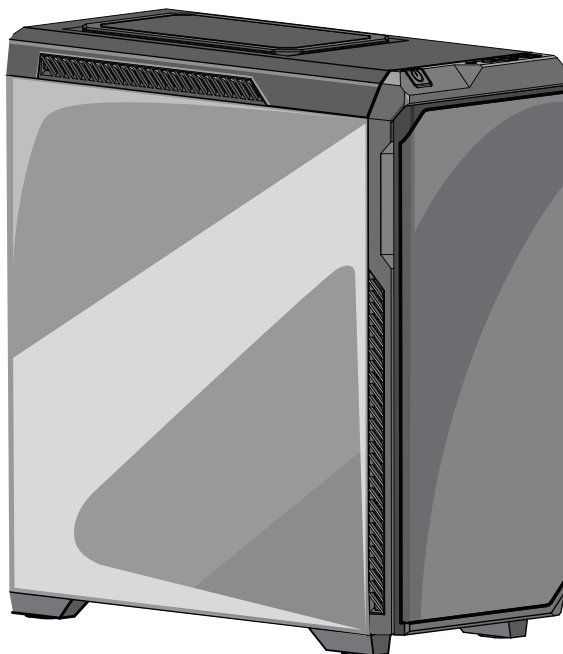

※ To ensure safe and easy installation, please read the following precaution.
Product design and specifications may be revised to improve quality and performance.

WWW.ZALMAN.COM

Ver.161215

English

1. Cautionary Note

- ❶ Please read this manual thoroughly prior to installation.
- ❷ Before installing, check the components and condition of the product, and if any problem is found, contact the retailer.
- ❸ Please wear gloves while handling this product to prevent injuries.
- ❹ Incorrect cable connections may cause short circuits leading to fire hazards.
- ❺ Do not block the front intake vent or the rear exhaust vent.
- ❻ Keep this unit away from heat sources, direct sunlight, water, oil and place the unit on a flat and well-ventilated area.
- ❼ Do not clean the product surface with chemicals or wet cloth. (chemicals: industrial alcohol, paint thinner and organic solvent etc.)
- ❽ Avoid inserting objects or hands into the system while it is in operation to prevent product damage and injuries.
- ❾ Zalman Tech Co., Ltd. is not responsible for any improper use.
- ❿ Product design and specifications may be revised to improve quality and performance.

2. Components

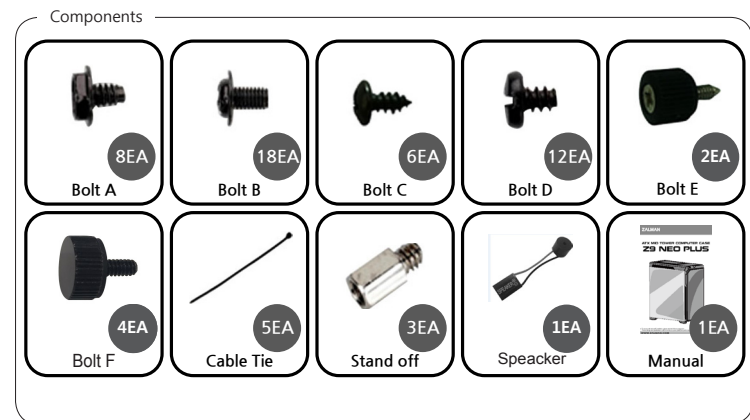

3. Top I/O Ports

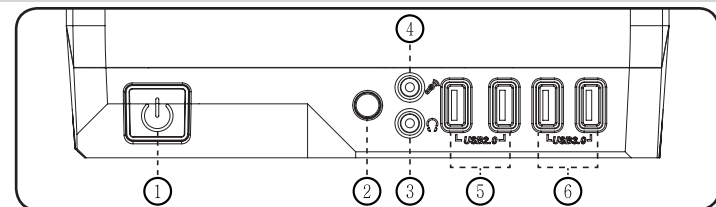

#	Part	#	Part
①	Power Button	②	Reset Button
③	Headphones	④	Mic
⑤	USB 2.0	⑥	USB 3.0

4. Installation

1 Side Panel Removal

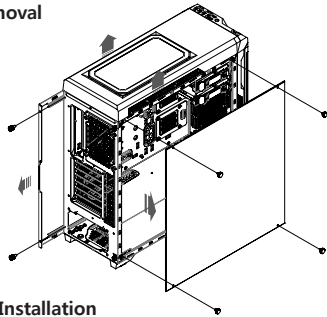

2 Motherboard Installation

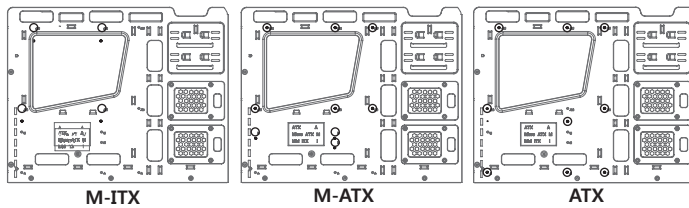

There are 6 Stand-offs preinstalled. Please refer to the diagrams below for additional Stand Off positions (based on motherboard type).

3 VGA Card Installation

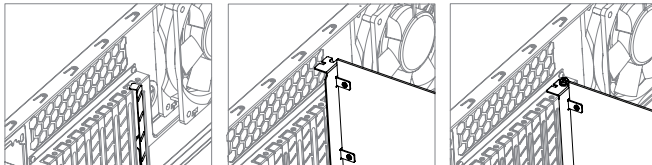

Unfasten the Hand Screw holding the PCI Cover and disassemble the cover. Remove the PCI Slot Cover. Install the VGA Card and fasten with a fixing screw.

4 5.25" Drive Installation

■ Front Cover Removal

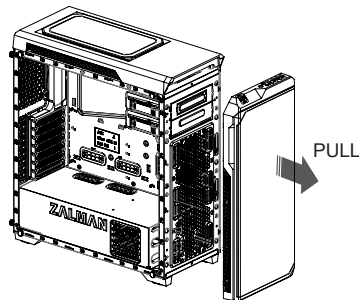

■ ODD Installation

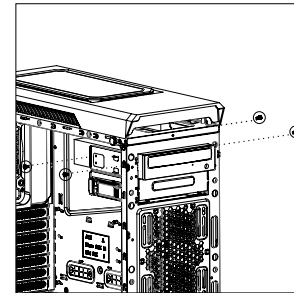

5 3.5", 2.5" HDD Installation

■ Install the Drive on HDD tray

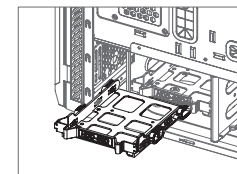

then remove the HDD Tray as shown in the figure.

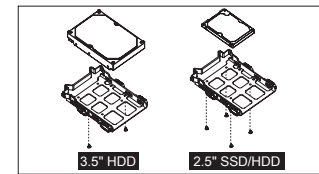

Install the tray on the drive.

■ Install the Drive on HDD tray

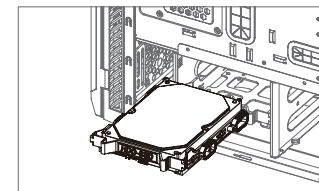

Tip

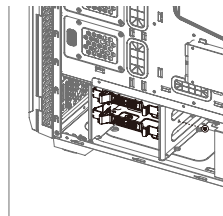

※ When transporting an assembled system, Please secure the HDD white Bolt as shown above

6 Cable Connection

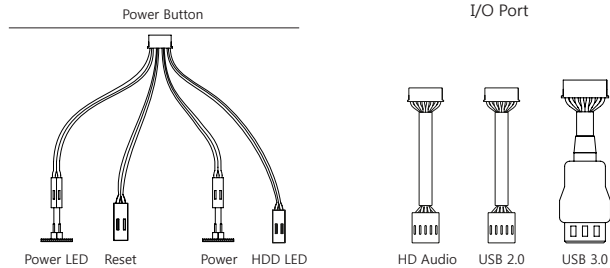

7 How to Install the Cooler

As shown in the picture, install the cooler on the top of the case using bolts

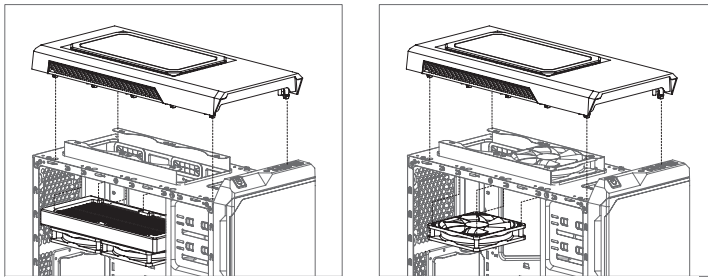

5. Warranty Information

Zalman Tech products come with the following limited warranties:

- 1 Year Warranty
CPU coolers (All CNPS series, Reserator 3 Max series, LQ3xx series), computer cases, keyboards, mice, laptop coolers, case fans, hardware enclosures (including VE series), audio devices, and all other accessories not specified below.
- 3 Year Warranty
HQ series AIO CPU coolers
- 7 Year Warranty
EBT series Power Supply Units
Zalman USA has the right to change availability of limited warranty at its own discretion and any changes will not be retroactive.
- The limited warranty does not cover...
 1. Non-Zalman brand products and accessories.
 2. Problems resulted from external causes such as accident, abuse, misuse, and/or problems with electrical power.
 3. Any service not authorized by Zalman USA.
 4. Usage that is not in accordance with product instructions.
 5. Failure to follow the product instructions and/or failure to perform preventive maintenance.
 6. Problems caused by using accessories, parts, and/or components not supplied by Zalman.
 7. Products with missing, altered Service Tags and/or serial numbers.
- For United States and Canada
Technical support and warranty related inquiries: support.usa@zalmanusa.com
Toll free customer service: 1-888-925-6266
- For all other regions
Send e-mail to techsupport@zalman.co.kr
For detailed warranty information, please visit www.zalman.com.

한국어

1. 주의사항

- ❶ 설치 전 설명서를 숙독하십시오.
- ❷ 설치 전 제품과 구성품을 반드시 확인 후 이상이 있을 경우 구입처에 교환/환불 조치 받으십시오.
- ❸ 제품 설치 시 사고 예방을 위해 장갑을 착용하고 취급하십시오.
- ❹ 시스템 장착 시 치명적 손상이 발생할 수 있으므로 무리한 힘을 가하지 마십시오.
- ❺ 케이블을 잘못 연결하면 화재로 인한 화재 우려가 있어 필히 설명서를 참고하여 연결하십시오.
- ❻ 시스템 사용시 제품의 통풍구가 막히지 않도록 주의 하십시오.
- ❼ 직사광선, 물, 습기, 기름, 먼지가 많은 곳을 피하고 공기가 잘 통하는 곳에서 보관/사용 하십시오.
- ❽ 화학약품 등으로 제품의 표면을 닦지 마십시오. (알코올 또는 아세톤 등 유기용제)
- ❾ 동작 중에는 인체나 제품에 해를 끼칠 수 있으므로 손이나 물체를 넣지 마십시오.
- ❿ 어린이의 손이 닿지 않는 곳에서 보관/사용하십시오.
- ⓫ 정해진 용도 외의 사용 및 소비자 부주의로 발생한 문제는 당사에서 책임지지 않습니다.
- ⓬ 제품의 외관 디자인 및 규격은 품질 향상을 위해 소비자에게 예고 없이 변경될 수 있습니다.

2. 구성품

공용구성품

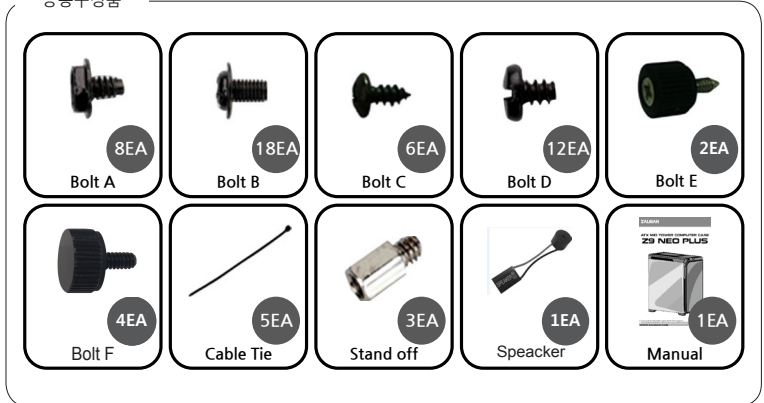

3. 상면 I/O 포트

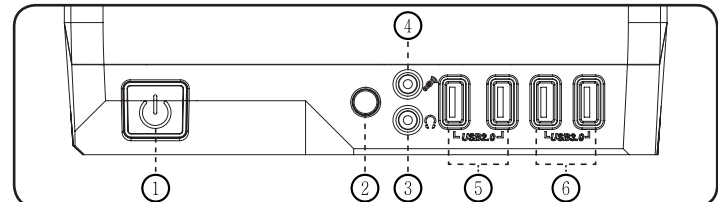

#	명칭	#	명칭
①	전원 버튼	②	리셋버튼
③	헤드폰	④	마이크
⑤	USB 2.0	⑥	USB 3.0

4. 설치방법

1 사이드 커버 분리

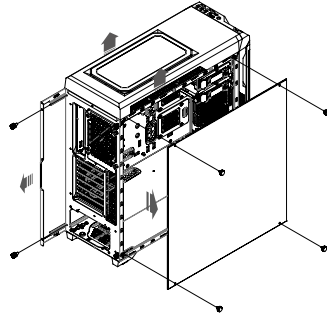

2 마더보드 설치

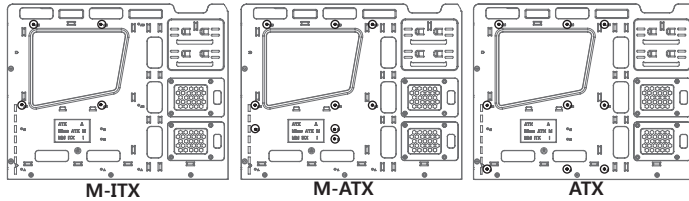

기본 6개의 Stand-Off가 장착되어 있으며, 메인보드 장착 볼트 위치를 참조하여 마더보드 타입에 따라 Stand-Off를 추가로 끼우고 마더보드를 케이스에 장착합니다.

3 그래픽 카드 설치

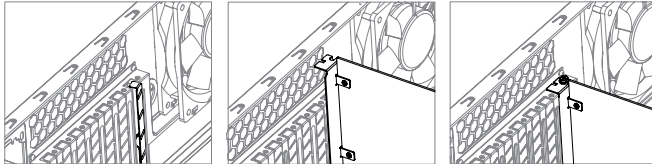

PCI 커버를 고정하는 볼트를 풀고 커버를 분리한 후 PCI 커버를 제거합니다. 그래픽 카드를 설치하고 고정나사로 고정합니다.

4 5.25" 드라이브 설치

■ 전면 커버 제거

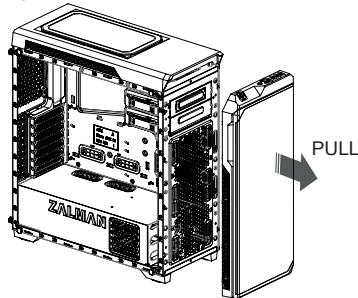

■ ODD 설치

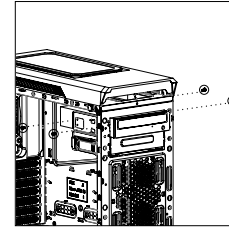

5 3.5" & 2.5" HDD 설치

■ HDD 트레이에 드라이브 설치

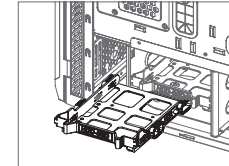

HDD Tray를 그림과 같이 분리합니다.

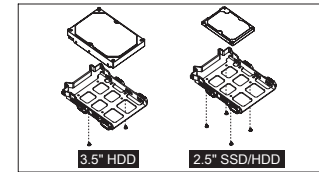

트레이에 드라이브를 장착합니다.

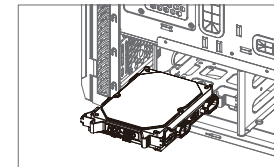

■ HDD 트레이에 HDD 장착

Tip

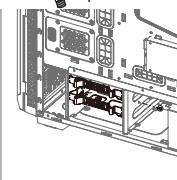

※ 조립후시스템을 이동할 때는 해당위치에 나사로 HDD를 고정해 주시기바랍니다

6 케이블 연결

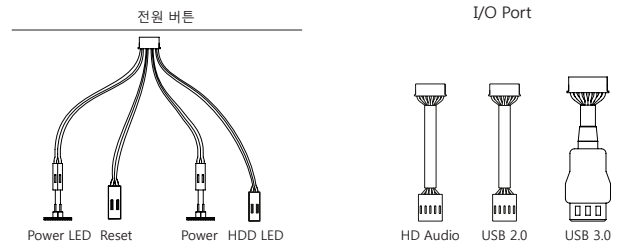

7 클러, 팬 장착방법

그림과 같이 케이스 상단 장착 홀에 맞추어 볼트를 이용하여 장착 할 수 있습니다.

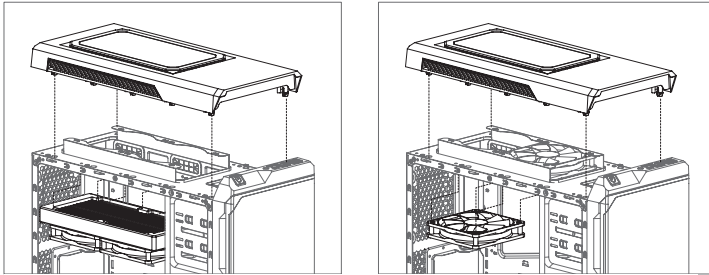

5. 품질보증 및 A/S 안내

1. 품질 보증기간 : 제품 구입일로부터 1년 (단, 구입영수증이 있을 때)
2. 무상 A/S : 품질 보증기간 내에 제품 자체 성능상의 하자 및 불량 발생시
3. 유상 A/S : 품질 보증기간 이후에 제품 사용상의 문제 발생시. 단, 아래와 같은 사항에 대해서는 품질 보증기간 이내라도 무상 A/S 처리가 되지 않으며 소비자 부담으로 처리됩니다.
 - ※ 본 사용 설명서에 명시된 설치 전 주의사항 및 유의사항을 지키지 않은 경우
 - ※ 사용자의 고의나 과실 및 부주의로 인하여 변형, 파손/파괴된 경우
 - ※ 사용자의 임의 개조에 의한 변형 및 고장이 발생한 경우
 - ※ 품질 보증 스티커가 제거 또는 훼손 되었을 경우
 - ※ 천재 지변으로 인해 고장이 발생한 경우
4. A/S
 - 1) 운영시간 : 평일- 09:00~18:00 (공휴일,토,일요일 휴무)
 - 2) 접수 방법
 - ① 방문 접수 : 직접 방문할 경우 사전 연락 후 방문해 주시기 바랍니다.
 - ② 택배 접수 : 택배(우편)를 이용하실 경우 성함, 주소, 연락처 및 불량 증상을 적은 메모지를 넣어서 보내주시시오.
※ A/S 의뢰 시 제품 박스가 필요하오니 보관하여 주십시오.
 - 3) 접수처
 - ◆ 고객센터 - ☎ 1588-3936
 - ※ A/S 의뢰 시 제품은 A/S접수처로 보내시는 것을 원칙으로 합니다.
5. 제품 운송비용
 - 1) 무상 A/S의 경우 : 무상 기간 내의 택배 운임비는 1회(선불) 고객 부담을 원칙으로 합니다.
 - 2) 유상 A/S 및 보증기간 이후 : 왕복 비용 모두 고객 부담입니다.

Français

Español

Português

1. Précautions

- 1 Assurez-vous d'être bien informé du manuel du produit avant son installation.
- 2 Assurez-vous de vérifier l'état des composants et des produits, et s'il vous plaît consulter votre revendeur quand il y a une erreur.
- 3 Assurez-vous de porter des gants pour éviter les blessures ou les accidents lors de la manipulation de ce produit.
- 4 Il y a un risque d'incendie dû à un court-circuit si vous les connectez incorrectement.
- 5 Veillez à ne pas bloquer les aérations à l'avant et à l'arrière du produit.
- 6 Installez le produit dans des endroits aérés, plats, et exempt de vibrations sans lumière solaire directe, chaleur générée par le chauffage, éclaboussures d'eau (pluie), ou beaucoup d'humidité et d'huile.
- 7 Ne pas nettoyer le produit avec des produits chimiques (produits chimiques, cirages industriels, alcool, dissolvant, lubrifiant, détergent etc.)
- 8 Ne pas mettre la main ou des objets dans le produit actif. Cela peut nuire au corps humain et au produit.
- 9 Nous ne prenons aucune responsabilité pour les problèmes qui se produisent en raison d'une utilisation autre que l'usage prévu.
- 10 La conception ou les spécifications sont sujettes à modification sans préavis aux clients afin d'améliorer la qualité du produit.

1. Precauciones

- 1 Antes de instalar, leer rápidamente las instrucciones del producto.
- 2 Antes de instalar, verificar el estado del producto y los componentes y en caso de que haya anomalías consulte con el departamento de compras.
- 3 Para prevención de accidentes y heridas durante el manejo de este producto, usar guantes de seguridad.
- 4 Al conectar los cables, conecte los cables después de verificar el manual. En caso de mala conexión hay peligro de fuego por corto circuito.
- 5 Precaución en que el ventilador de la parte frontera y trasera del producto no este obstruido.
- 6 Evitar lugares que hay calor como lugares con rayo de sol directo o alrededor de calefacciones, lugares que salpica agua (luvia), lugares con mucho aceite o humedad e instalar en lugares que conduzca mucho aire, plano y que no haya vibraciones.
- 7 No limpiar la superficie del producto con medicamentos químicos. (Medicamentos químicos, barniz industrial, cera, benceno, alcohol, diluyente, medicamento para lubricante etc.)
- 8 No introducir las manos u objetos en los productos en movimiento. Puede causar daños al producto o al cuerpo.
- 9 La compañía no será responsable sobre los problemas ocurridos por el uso además del uso determinado.
- 10 El diseño exterior y el modelo del producto puede ser cambiado sin aviso previo al consumidor para el mejoramiento de calidad del producto.

1. Precauções

- 1 Verifique as instruções antes da instalação
- 2 Verifique o estado do produto e seus componentes antes da instalação caso exista algum defeito, entre em contato com o vendedor para solicitar substituição / reembolso
- 3 Use as luvas quando instalar este produto para evitar acidentes
- 4 Não utilize força excessiva sobre o produto, pois isso pode causar o dano físico
- 5 As conexões de cabo de forma incorreta podem provocar curto-circuito com riscos de incêndio, consulte o manual antes da conexão
- 6 Não bloqueie a entrada de ventilação da frente ou a saída de ar traseira
- 7 Mantenha este produto longe da luz direta do sol, água, umidade, óleo e poeira e coloque-o em área bem ventilada
- 8 Não limpe a superfície do produto com produtos químicos (solventes orgânicos, tais como álcool ou acetona)
- 9 Não insira objetos ou as mãos no produto em funcionamento para evitar o dano ao produto e prevenir lesões
- 10 Mantenha este produto longe do alcance de crianças
- 11 Zalman Tech S.A.R.L. não é responsável por quaisquer problemas que possam ocorrer devido ao uso inadequado
- 12 O desenho e as especificações do produto podem estar sujeitos a alterações para melhoria da qualidade e desempenho sem aviso prévio ao consumidor

2. Composants, Precauciones, Precauções

Composants / Precauciones / Precauções

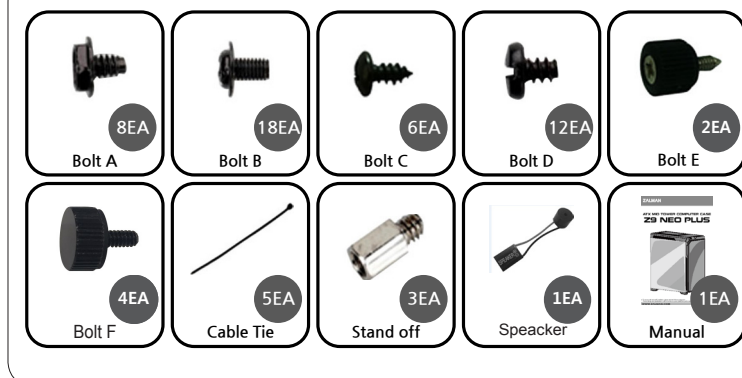

3. Top I/O Ports, Puerto de I/O en superficie, Porta I/O de superficie

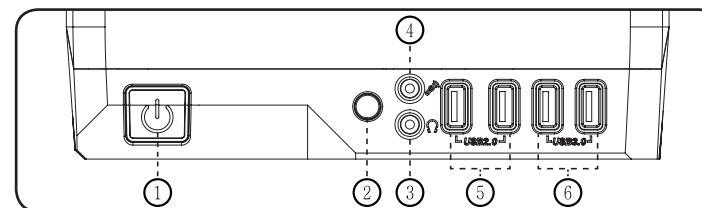

#	Part Name	#	Part Name
①	Bouton d'alimentation / Botón de Potencia / Botão de alimentação	②	Bouton de réinitialisation / Botón de Reinicio / Botão de reset
③	Casque / Audífonos / Fone de ouvido	④	Mic
⑤	USB 2.0	⑥	USB 3.0

4. Installation

1 Side Panel Removal / Retrait du panneau latéral / Remoção da tampa lateral

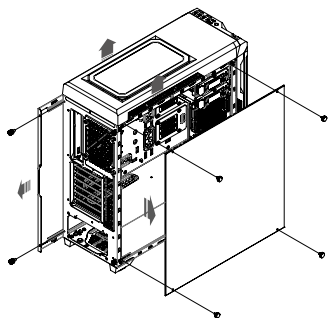

2 Motherboard Installation / Installation de la carte mère / Instalação de placa-mãe

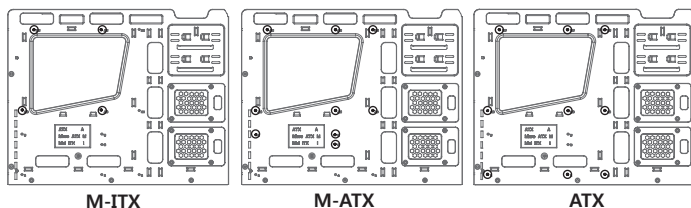

There are 6 Stand Offs preinstalled. Please refer to the diagrams below for additional Stand Off positions (based on motherboard type).

Il ya 6 Offs de stands préinstallés. S'il vous plaît se référer aux schémas ci-dessous pour Stand Off postes supplémentaires (selon le type de carte mère).

Há seis isoladores impasse pré-instalados. Consulte a figura abaixo para montar um isolador impasse adicional e instalar a placa-mãe para o caso de acordo com o tipo de placa-mãe

3 Assemblage de la carte graphique / Ensamblaje de tarjeta grafica / Instalação do cartão VGA

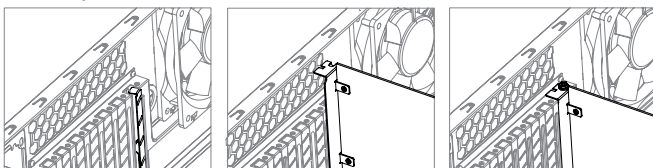

Desserrer la vis à la main qui fixe le couvercle de PCI et séparer le couvercle. Retirer le couvercle du logement PCI. Installer la carte graphique et la fixer avec vis de fixation.

Separar el cubierto desarmando el tornillo de mano que fija el cubierto PCI. Remover el cubierto de la ranura PCI. Instalar la tarjeta grafica y fijar con tornillo.

o parafuso de mão que fixa a tampa de PCI e desmonte a tampa Retire a tampa do PCI Instale o cartão VGA e aperte com o parafuso de ajuste

4 Installation des lecteurs de 5.25" / Instalación de unidades de 5.25" / Instalação da unidade de 5,25 "

- Séparation de couvercle avant / Remove tapa frontal / Remoção da tampa frontal

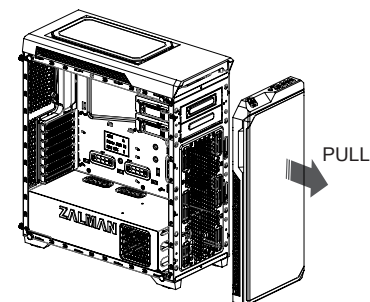

- Installation de l'ODD / Instalar ODD / Instalação de ODD

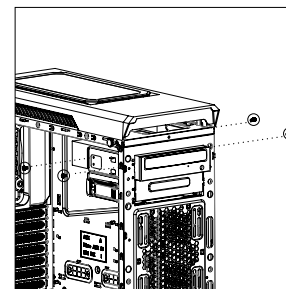

5 Montage de HDD de 3.5", 2.5" / Instalar bandeja 3.5",2.5" / Instalar bandeja 3.5",2.5"

- Installer le lecteur sur le plateau de disque dur / Instale la unidad en la bandeja de la unidad de disco duro / Instalação do HD na bandeja do módulo

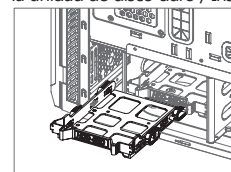

retirer le plateau de disque dur comme illustré sur la figure.

Retire la bandeja

Remova a bandeja

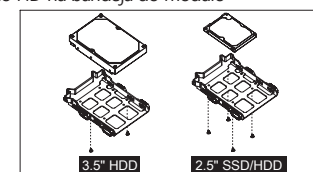

Installation du disque sur le plateau

Equipar disco de bandeja

Instale o HD na bandeja conforme figura.

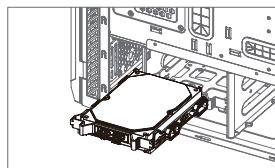

- Installation de HDD Tray /Instalar HDD Tray / Instalação do módulo



Tip

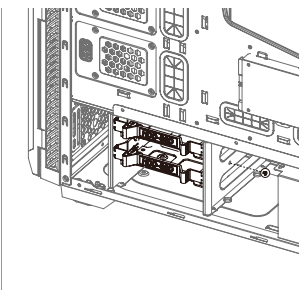

- ※ Lorsque vous déplacez le système à l'ensemble à sa place Vis A pour écuriser le disque dur s'il vous plaît.
- ※ Al mover el sistema a la asamblea en su lugar Tornillos A para asegurar la unidad de disco duro, por favor.
- ※ Quando transportar um sistema montado, por favor garantir o HDD com Parafuso A como mostrado cima.

6 Connexion des câbles / Cable Connection / cabo de Conexão

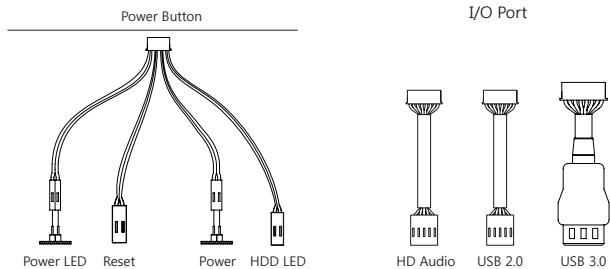

7 Montage du refroidisseur / Instalación del enfriador / Instalando o refrigerador

Fixer le refroidisseur avec les boulons pour s'adapter aux trous de montage sur le dessus du boîtier comme indiqué dans la figure.

Encaje el enfriador en el orificio de instalación de la parte superior de la caja y luego instálelo con el tornillo como se muestra en la figura

Furos de montagem, como mostrado na figura em cima do caso, utilizando os parafusos de montagem para se adequar.

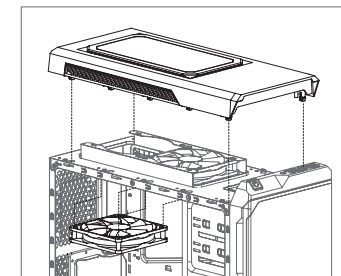
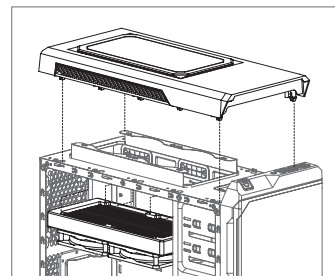

ZALMAN
WWW.ZALMAN.COM