

APP



Google Play and the Google Play logo are trademarks of Google Inc.



Apple and the Apple logo are trademarks of Apple Inc.

Download the soundcore app to check battery level of the earclips, customize controls, experience dual connections, update firmware, and explore more exciting features.

If your earclips cannot connect to the soundcore app, re-install the app or update it to the latest version from your mobile app store.

OVERVIEW

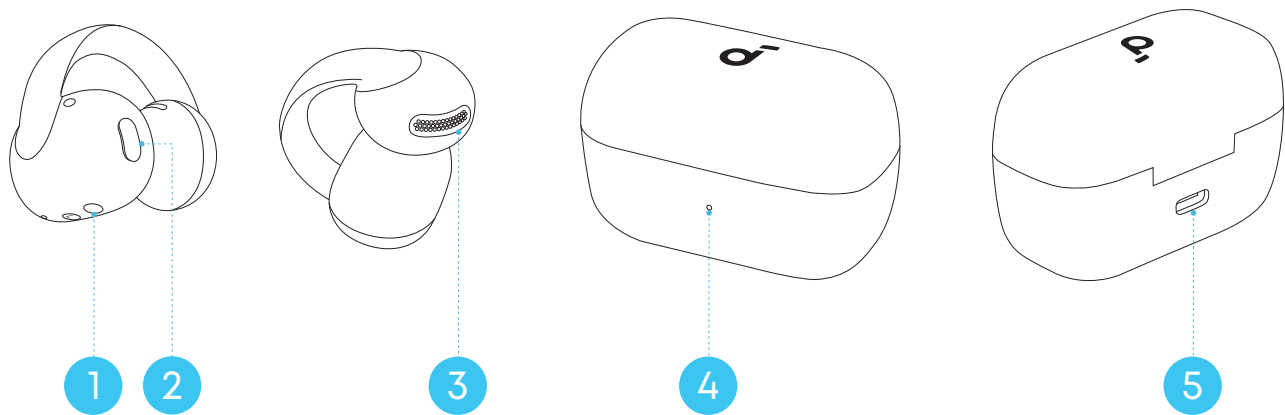

1. Earclip Charging Contact
2. Earclip Button
3. Sound Outlet
4. LED Indicator
5. USB-C Charging Port

WEARING

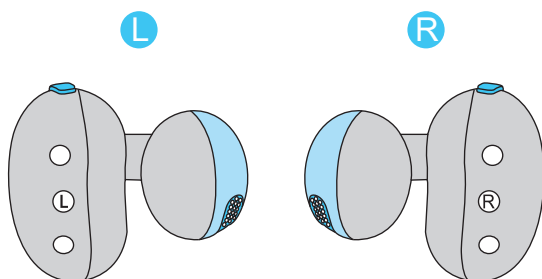

1. Make sure to identify the left and right earclips before wearing.

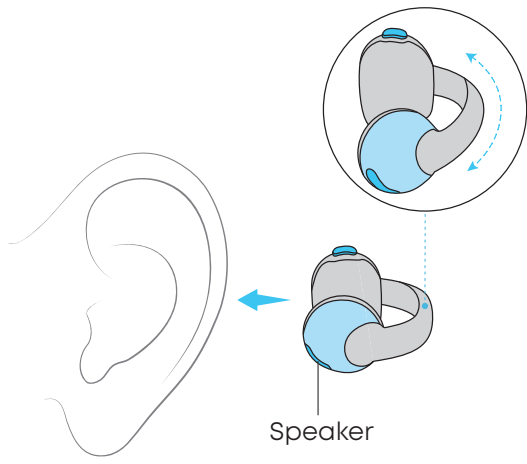

2. Speaker (smaller part) in front and battery housing (with button) at the back.

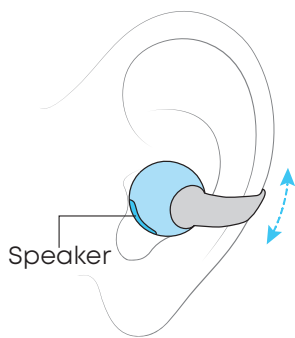

3. Adjust the earclips up or down for a comfortable position.

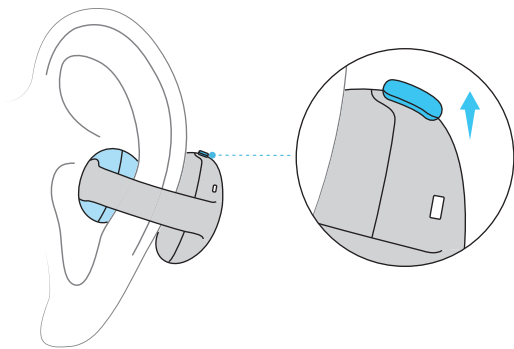

Note: The button should sit behind the ear and face upward.

POWERING ON & PAIRING

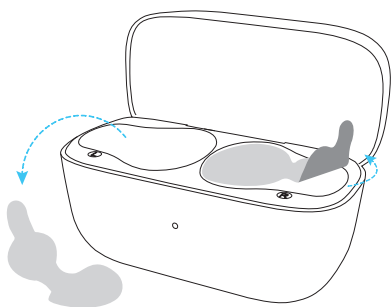

1. Remove the protective films first.

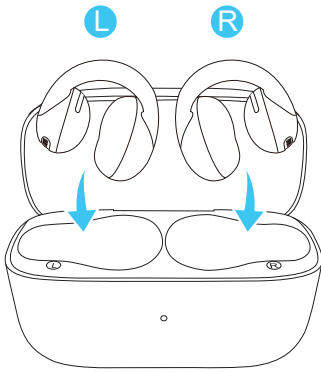

2. Return the earclips to the case and close the lid.

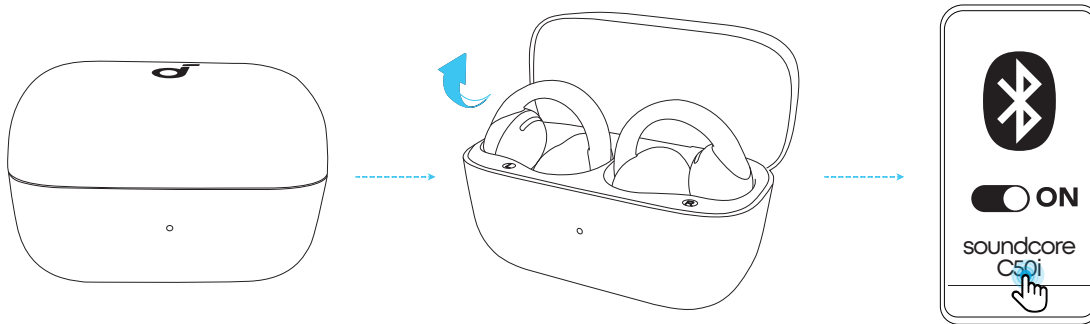

3. Open the lid to power on the earclips, then wear them. You'll hear a prompt tone, indicating they are in pairing mode. Select "**soundcore C50i**" from your device's Bluetooth list to connect.

- After pairing is successful, you will hear a prompt tone.

MANUAL PAIRING

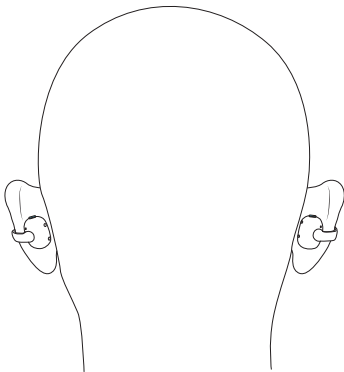

1. Wear the earclips.

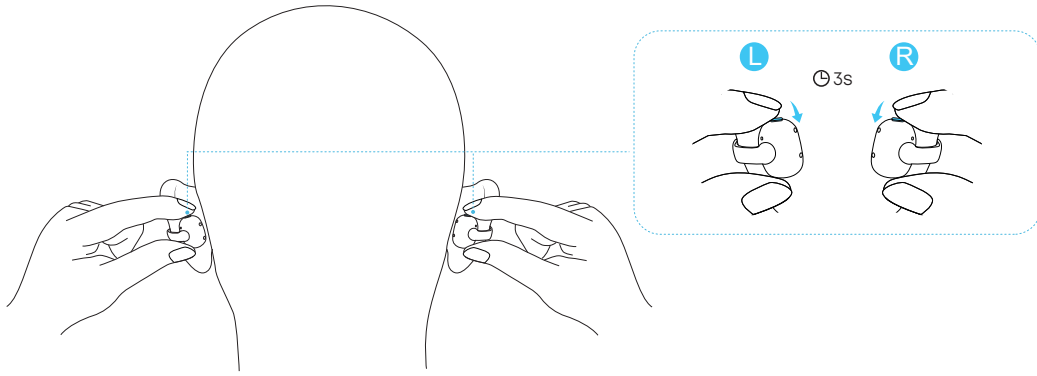

2. Press and hold the button on both earclips for 3 seconds simultaneously until you hear a prompt tone.
3. Let go, and the earclips will enter pairing mode. Proceed to pair with your device.

CHARGING

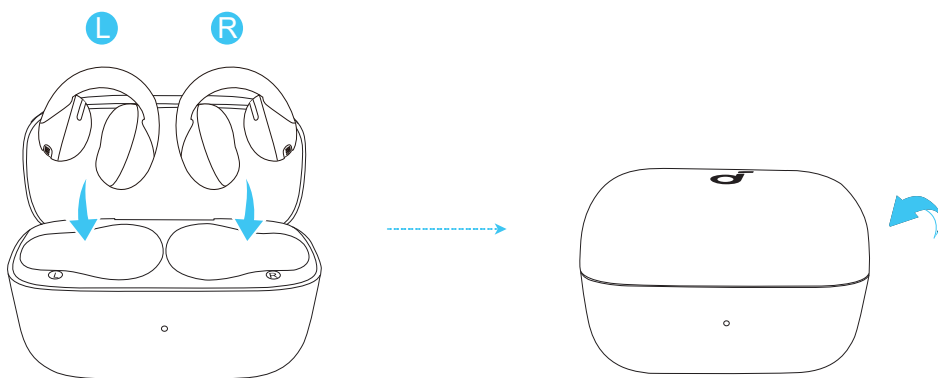

1. Place the earclips in the charging case and close it.
 - Ensure the earclips and the USB-C charging port are fully dry before charging.

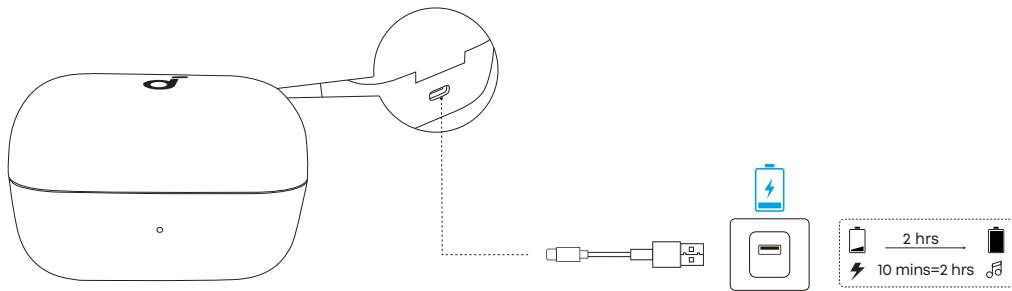

2. Connect the charging case to a power supply using the USB-C charging cable provided.
 - The charging case fully recharges in about 2 hours, and a 10-minute charge offers 2 hours of playtime.

DUAL CONNECTIONS

To connect your earclips with two Bluetooth devices at the same time, there are two methods:

Method 1: Manually Pair with the Second Device

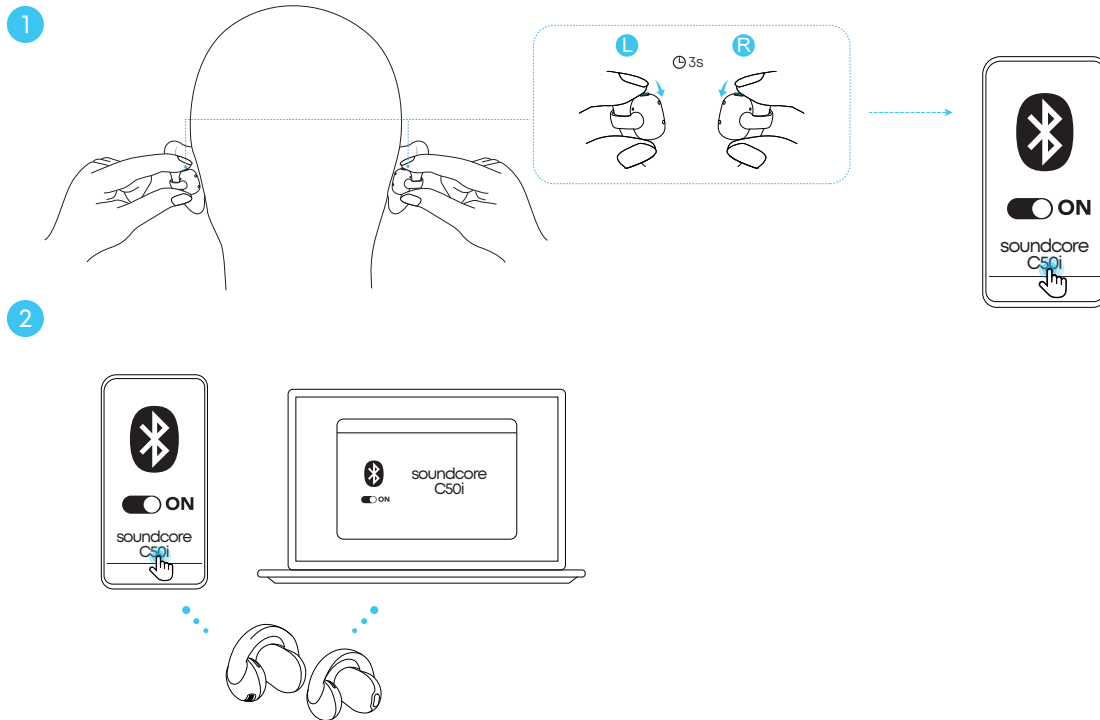

Wear the earclips, press and hold the button on both earclips for 3 seconds simultaneously until you hear a prompt tone. The earclips will enter Bluetooth pairing mode, and you can then proceed to pair them with the second device.

Method 2: Use the soundcore App

In the soundcore app, tap the cogwheel icon in the upper-right corner to access **Settings**. Then, select **Dual Connections > Enable Dual Connections > Connect New Device**.

 Dual Connections is enabled by default.

AI TRANSLATION

Before Use:

- Make sure your earbuds is connected to the app when using AI Translation.
- Disable Dual Connections.

Real-Time Translation

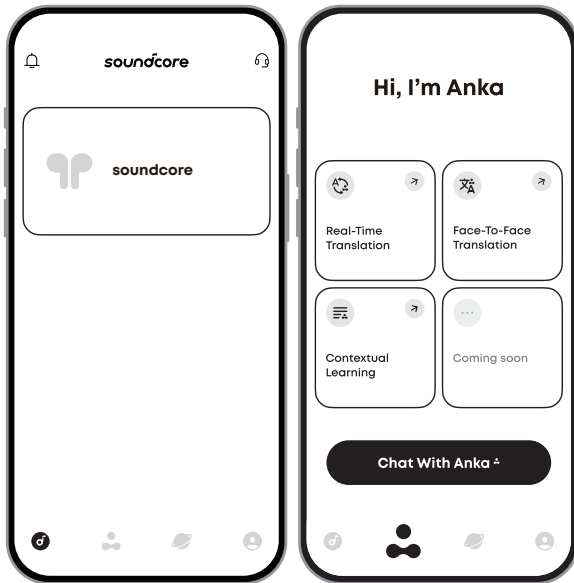

In the soundcore app, go to **Anka > Real-Time Translation**. Make sure your earclips are connected to the app.

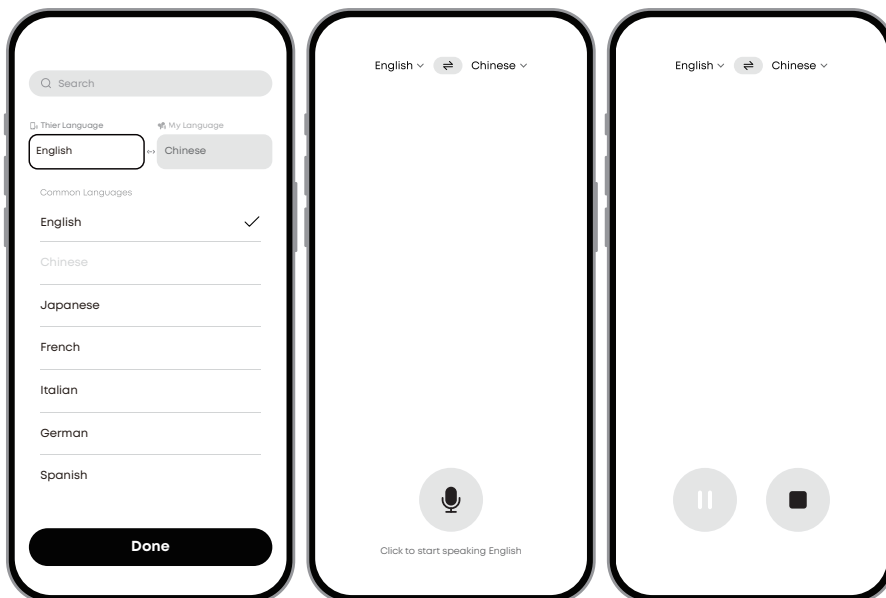

The translation is displayed in real time in the app.

1. Tap **Real-Time Translation**.
2. Tap the language section at the top of the page, then select **Their Language** and **My Language**.
3. Tap the microphone button to start recording. Tap the left button to pause, and the right button to exit **Real-Time Translation**.

 Supports 100 languages.

Face-to-Face Translation

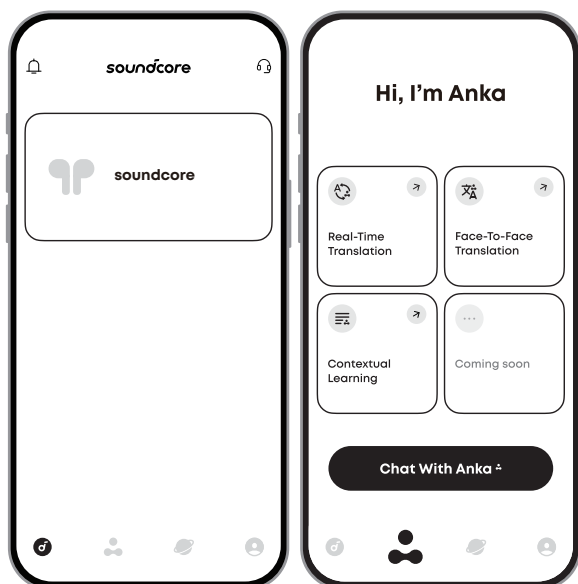

In the soundcore app, go to **Anka > Face-to-Face Translation**. Make sure your earclips are connected to the app.

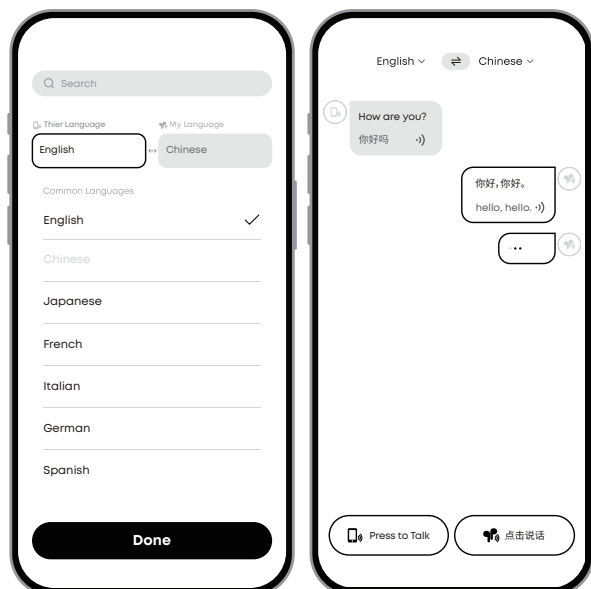

1. Tap the language section at the top of the page, then select **Their Language** and **My Language**.
2. Tap the bottom-right button and speak into your earclips. The translation will play from your phone.
3. Tap the bottom-left button and speak into your phone. The translation will play from your earclips.

 Supports real-time translation of conversations in 100 languages.

LDAC

To use the LDAC codec, your device must be running Android 8.0 or higher.

LDAC offers higher sound quality but uses more power, which may reduce battery life.

For a stable Bluetooth connection, enable LDAC in low-interference environments.

Note: UI images are for illustrative purposes only; actual display may vary by software version.

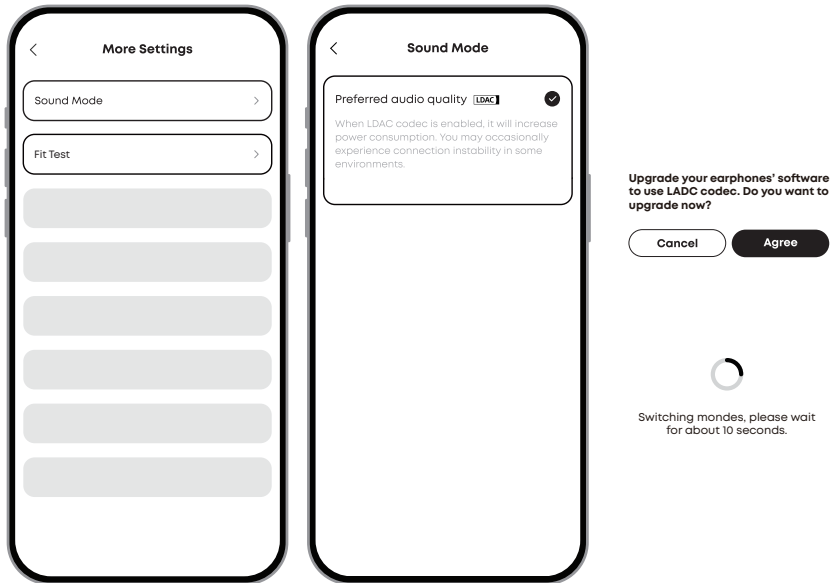



In the soundcore app:

1. Select **Sound Mode**.
2. Tap **Preferred audio quality**.
3. Tap **Agree** to proceed.
4. Switching audio codecs takes about 10 seconds. You may be prompted to update the firmware if a new version is available.

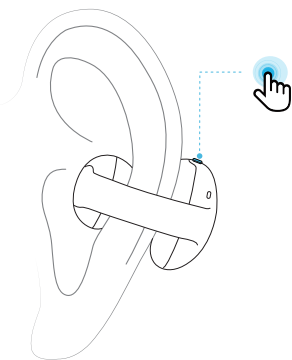
CONTROLS



		Using Both Earclips	Using Single Earclip
🎵	Play / Pause Audio	Single tap (L/R)	Single tap (L/R)
	Play the Next Track	Double tap (R)	Double tap (L/R)
	Play the Previous Track	Double tap (L)	/
🔊+	Increase Volume	Hold the right earclip (R) for at least 2 seconds to increase volume until the desired level is reached	/

	Decrease Volume	Hold the left earclip (L) for at least 2 seconds to decrease volume until the desired level is reached	/
	Answer Call	Single tap (L/R)	Single tap (L/R)
	Hang Up	Hold for 2 seconds (L/R)	Hold for 2 seconds (L/R)
	Reject Call	Hold for 2 seconds (L/R)	Hold for 2 seconds (L/R)
	Manual Pairing	Press and hold the button on both earclips for 3 seconds	/

 You can also customize tap controls in the soundcore app.

POWERING OFF

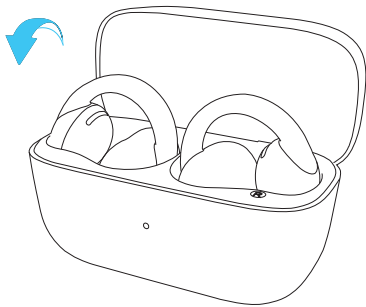

To power off, place both earclips in the charging case and close the lid.

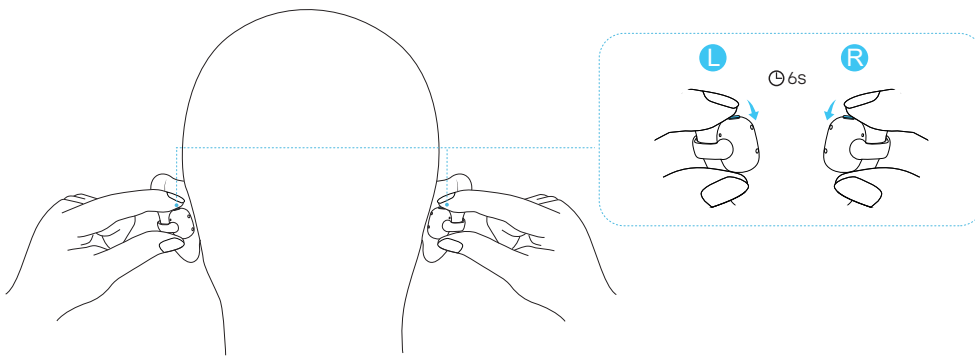

If you do not have the charging case with you, press and hold the buttons on both L and R earclips for 6 seconds to power off.

RESET

Reset the earclips if you encounter functionality issues.

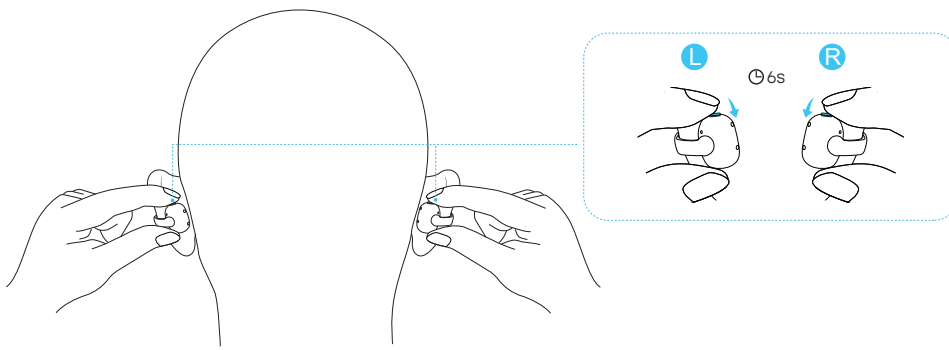

Press and hold the buttons on both L and R earclips for 6 seconds until the earclips power off.

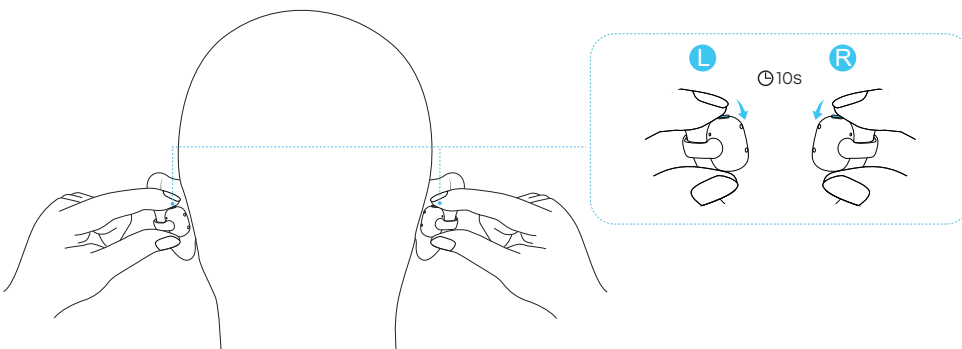

Press and hold the buttons on both L and R earclips again for 10 seconds to reset.

Note: If you hear the power-on tone while resetting, do not release the buttons until the operation is complete.

LED LIGHT GUIDE

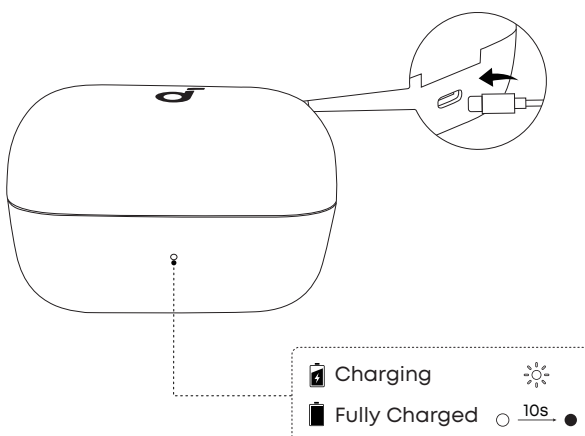

When you connect the charging case to a power source, the LED indicator will display the charging status.

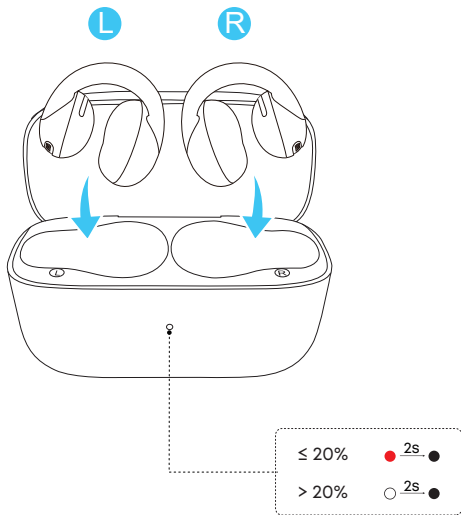

Place both earclips in the charging case to check the battery level of the charging case.

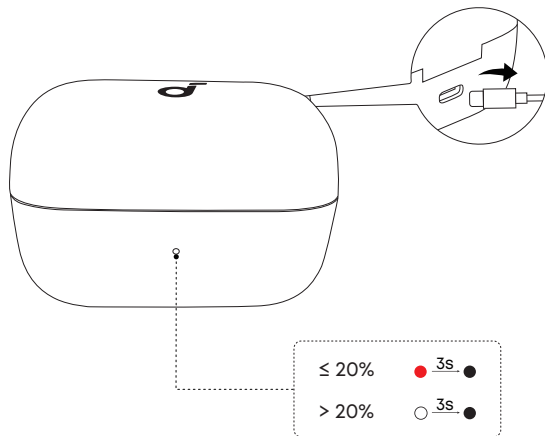

When you disconnect the charging case from a power source, the LED indicator will display the charging case's battery level.

HOW TO CLEAN

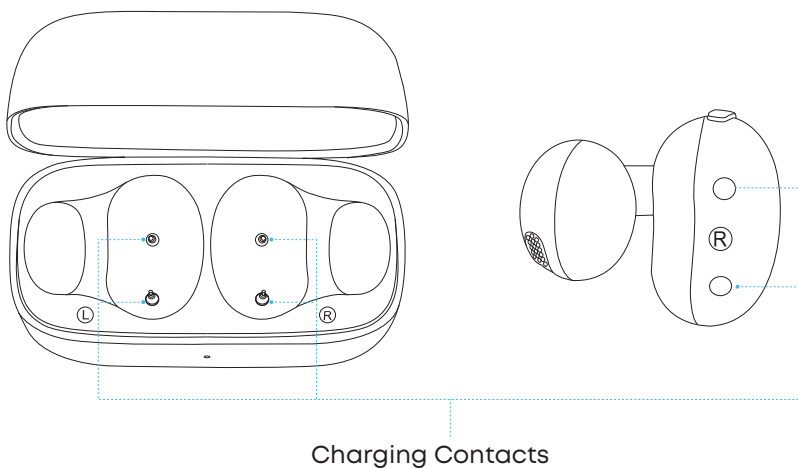

After each use, wipe the earbuds with a soft, dry cloth and clean the charging contacts with a cotton swab to prevent charging and power-off issues caused by sweat accumulation.

FIRMWARE UPDATE

You will be notified when a new firmware version is available while the earclips are connected to the app. Please note the following during the update process:

- 1. Do not** disconnect your phone or play audio during installation.
- 2. Do not** place the earphones in the charging case.
3. Keep the earphones within 0.5 m of your phone.

SPECS

Specifications are subject to change without notice.

Input	5V $\overline{=}$ 1A
Output	5V $\overline{=}$ 0.25A
Battery capacity	60mAh \times 2 (Earclips) 580mAh (Charging Case)
Playtime	Up to 7H (Up to 28H with Case)
Charging time	2H
Driver unit	12 mm
Frequency response	20~20kHz (40kHz in LDAC Mode)
Impedance	14 Ω \pm 15%
Waterproof rating (earbuds)	IP55
Bluetooth version	6.0
Bluetooth range	15 m

CUSTOMER SERVICE

service@soundcore.com

uk.support@soundcore.com (uk)

ie.support@soundcore.com (Ireland)



support.india@anker.com (India)

support.mea@anker.com (For Middle East and Africa Only)

support@anker.com (日本)

support.kr@anker.com (한국)

ced-cn@anker.com

+1 (800) 988-7973 (US/Canada)

+44 (0) 1604 936 200 (UK)

+49 (0) 69 9579 7960 (DE)

03 4455 7823 (日本)

+86 400 0550 036 (中国)



+82 1666-8470 (한국)

+971 8000 320 817 (UAE)

+966 8008 500 030 (KSA)

+965 22069086 (Kuwait)

+20 8000 000 826 (Egypt)

+90 (850) 460 1414 (Türkiye)

+91 8000 504 414 (India)

Note: The 'x' of SN Code: xxxxxxxxxxxxxxxx is a variable, see below table.

Variable 'x'	Range of variable	Content
Eighth	0-9 or A-F	Denotes the hardware version which is not effected on the safety compliance.
Ninth	8,9,A,B,C...	Denotes the year, 8 means 2018, 9 means 2019, A means 2020, B means 2021, C means 2022, and so on.
Tenth and Eleventh	01,02,03...	Denotes weeks, 01 means the first week in this year, 02 means the secondary week in this year, and so on.
Twelfth	1-7	Denotes date, 1 means Monday, 2 means Tuesday..., 7 means Sunday and so on.
The last five	00001-99999	Denotes serial No.

Hereby, Anker Innovations Limited declares that this device is in compliance with The Product Security and Telecommunications Infrastructure (Security Requirements for Relevant Connectable Products) Regulations 2023. For the Statement of Compliance, visit the website: <https://uk.soundcore.com/pages/psti-related>.