

TCL

Dehumidifier User Manual

DFL3-20EB

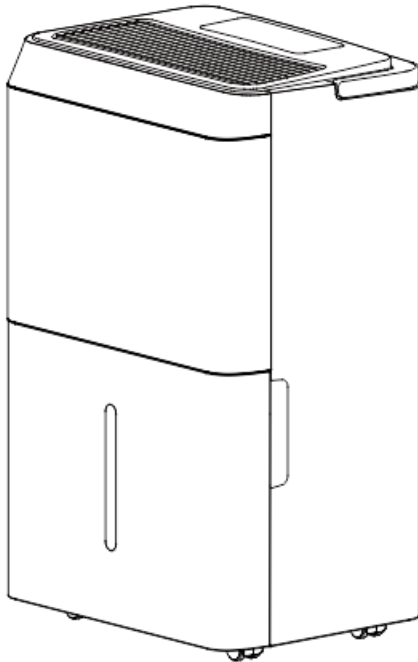

Thank you for selecting our quality appliance. Please be sure to read this user manual carefully before using. Any question, please contact the professional service for help.

IMPORTANT SAFEGUARDS

VERY IMPORTANT!

Please do not install or use your appliance before you have carefully read this manual. Please keep this instruction manual for an eventual product warranty and for future reference.

GENERAL SAFETY INSTRUCTION

- 1.The appliance is for indoor use only.
- 2.Do not use the unit on a socket under repairs or not installed properly.
- 3.Do not use the unit, follow these precautions:
 - A: Near to source of fire.
 - B: An area where oil is likely to splash.
 - C: An area exposed to direct sunlight.
 - D: An area where water is likely to splash.
 - E: Near a bath, a laundry, a shower or a swimming pool.
- 4.Never insert your fingers, rods into the air outlet. Take special care to warn children of these dangers.
- 5.Keep the unit upward while transport and storage, for the compressor locates properly.
- 6.Before cleaning the appliance, always turn off or disconnect the power supply.
- 7.When moving the appliance, always turn off and disconnect the power supply, and move it slowly.
- 8.To avoid the possibility of fire disaster, the appliance shall not be covered.
- 9.All the appliance sockets must comply with the local electric safety requirements. If necessary, please check it for the requirements.
- 10.Children should be supervised to ensure that they do not play with the appliance.
- 11.If the supply cord is damaged, it must be replaced by the manufacturer, its service agent or similarly qualified persons in order to avoid a hazard.
- 12.This appliance can be used by children aged from 8 years and above and persons with reduced physical, sensory or mental capabilities or lack of experience and knowledge if they have been given supervision or instruction concerning use of the appliance in a safe way and understand the hazards involved. Children shall not play with the appliance. Cleaning and user maintenance shall not be made by children without supervision.
- 13.The appliance shall be installed in accordance with national wiring regulations.
- 14.Details of type and rating of fuses: T, 250V AC, 3.15A .
- 15.Recycling



This marking indicates that this product should not be disposed with other household wastes throughout the EU. To prevent possible harm to the environment or human health from uncontrolled waste disposal, recycle it responsibly to promote the sustainable reuse of material resources. To return your used device, please use the return and collection systems or contact the retailer where the product was purchased. They can take this product for environmental safe recycling.

16. Contact authorized service technician for repair or maintenance of this unit.

17. Do not pull, deform or modify the power supply cord, or immerse it in water. Pulling or misuse of the power supply cord can result in damage to the unit and cause electrical shock.

18. Compliance with national gas regulations shall be observed.

19. Keep ventilation openings clear of obstruction.

20. Any person who is involved with working on or breaking into a refrigerant circuit should hold a current valid certificate from an industry-accredited assessment authority, which authorizes their competence to handle refrigerants safely in accordance with an industry recognized assessment specification.

21. Servicing shall only be performed as recommended by the equipment manufacturer. Maintenance and repair requiring the assistance of other skilled personnel shall be carried out under the supervision of the person competent in the use of flammable refrigerants.

22. Do not operate or stop the unit by inserting or pulling out the power plug, it may cause electric shock or fire due to heat generation.

23. Unplug the unit if strange sounds, smell, or smoke comes from it.

NOTES:

- If any parts damage, please contact the dealer or a designated repair shop;
- In case of any damage, please turn off the air switch, disconnect the power supply, and contact the dealer or a designated repair shop;
- In any case, the power cord shall be firmly grounded;
- To avoid the possibility of danger, if power cord is damaged, please turn off the air switch and disconnect the power supply. It must be replaced from the dealer or a designated repair shop.

WARNING

- Do not use means to accelerate the defrosting process or to clean, other than those recommended by the manufacturer.
- The appliance shall be stored in a room without continuously operating ignition sources (for example: open flames, an operating gas appliance or an operating electric heater).
- Do not pierce or burn.
- Be aware the refrigerants may not contain an odour.
- Appliance shall be installed, operated and stored in a room with a floor area larger than X m².

Quantity of R290 gas in charge (see rating label on the appliance) (g)	Minimum size of the site for use and storage (m ²)
m < 152	4
152 ≤ m ≤ 185	9
186 ≤ m ≤ 225	11
226 ≤ m ≤ 270	13
271 ≤ m ≤ 290	14
291 ≤ m ≤ 300	15

SPECIFIC INFORMATION REGARDING APPLIANCES WITH R290 REFRIGERANT GAS.

- Thoroughly read all of the warnings.
- When defrosting and cleaning the appliance, do not use any tools other than those recommended by the manufacturing company.
- The appliance must be placed in an area without any continuously sources of ignition (for example: open flames, gas or electrical appliances in operation).
- Do not puncture and do not burn.
- This appliance contains Y g (see rating label back of unit) of R290 refrigerant gas.
- R290 is a refrigerant gas that complies with the European directives on the environment. Do not puncture any part of the refrigerant circuit.
- If the appliance is installed, operated or stored in an unventilated area, the room must be designed to prevent to the accumulation of refrigerant leaks resulting in a risk of fire or explosion due to ignition of the refrigerant caused by electric heaters, stoves, or other sources of ignition.
- The appliance must be stored in such a way as to prevent mechanical failure.
- Individuals who operate or work on the refrigerant circuit must have the appropriate certification issued by an accredited organization that ensures competence in handling refrigerants according to a specific evaluation recognized by associations in the industry.
- Repairs must be performed based on the recommendation from the manufacturing company. Maintenance and repairs that require the assistance

of other qualified personnel must be performed under the supervision of an individual specified in the use of flammable refrigerants.

- Ducts connected to an appliance shall not contain a potential ignition source.



Caution, risk of fire

INSTRUCTIONS FOR REPAIRING APPLIANCES CONTAINING R290

1 GENERAL INSTRUCTIONS

1.1 Checks to the area

Prior to beginning work on systems containing flammable refrigerants, safety checks are necessary to ensure that the risk of ignition is minimised. For repair to the refrigerating system, the following precautions shall be complied with prior to conducting work on the system.

1.2 Work procedure

Work shall be undertaken under a controlled procedure so as to minimise the risk of a flammable gas or vapour being present while the work is being performed.

1.3 General work area

All maintenance staff and others working in the local area shall be instructed on the nature of work being carried out. Work in confined spaces shall be avoided. The area around the workspace shall be sectioned off. Ensure that the conditions within the area have been made safe by control of flammable material.

1.4 Checking for presence of refrigerant

The area shall be checked with an appropriate refrigerant detector prior to and during work, to ensure the technician is aware of potentially flammable atmospheres. Ensure that the leak detection equipment being used is suitable for use with flammable refrigerants, i.e. nonsparking, adequately sealed or intrinsically safe.

1.5 Presence of fire extinguisher

If any hot work is to be conducted on the refrigeration equipment or any associated parts, appropriate fire extinguishing equipment shall be available to hand. Have a dry powder or CO₂ fire extinguisher adjacent to the charging area.

1.6 No ignition sources

No person carrying out work in relation to a refrigeration system which involves exposing any pipe work that contains or has contained flammable refrigerant shall use any sources of ignition in such a manner that it may lead to the risk of fire or explosion. All possible ignition sources, including cigarette smoking, should be kept sufficiently far away from the site of installation, repairing, removing and disposal, during which flammable refrigerant can possibly be released to the surrounding space. Prior to work taking place, the area around the equipment is to be surveyed to make sure that there are no flammable hazards or ignition risks. "No Smoking" signs shall be displayed.

1.7 Ventilated area

Ensure that the area is in the open or that it is adequately ventilated before breaking into the system or conducting any hot work. A degree of ventilation shall continue during the period that the work is carried out. The ventilation should safely disperse any released refrigerant and preferably expel it externally into the atmosphere.

1.8 Checks to the refrigeration equipment

Where electrical components are being changed, they shall be fit for the purpose and to the correct specification. At all times the manufacturer's maintenance and service guidelines shall be followed. If in doubt consult the manufacturer's technical department for assistance. The following checks shall be applied to installations using flammable refrigerants: the charge size is in accordance with the room size within which the refrigerant containing parts are installed; the ventilation machinery and outlets are operating adequately and are not obstructed; if an indirect refrigerating circuit is being used, the secondary circuit shall be checked for the presence of refrigerant; marking to the equipment continues to be visible and legible. Markings and signs that are illegible shall be corrected; refrigeration pipe or components are installed in a position where they are unlikely to be exposed to any substance which may corrode refrigerant containing components, unless the components are constructed of materials which are inherently resistant to being corroded or are suitably protected against being so corroded.

1.9 Checks to electrical devices

Repair and maintenance to electrical components shall include initial safety checks and component inspection procedures. If a fault exists that could

compromise safety, then no electrical supply shall be connected to the circuit until it is satisfactorily dealt with. If the fault cannot be corrected immediately but it is necessary to continue operation, an adequate temporary solution shall be used. This shall be reported to the owner of the equipment so all parties are advised.

Initial safety checks shall include: that capacitors are discharged: this shall be done in a safe manner to avoid possibility of sparking; that there no live electrical components and wiring are exposed while charging, recovering or purging the system; that there is continuity of earth bonding.

2 REPAIRS TO SEALED COMPONENTS

2.1 During repairs to sealed components, all electrical supplies shall be disconnected from the equipment being worked upon prior to any removal of sealed covers, etc. If it is absolutely necessary to have an electrical supply to equipment during servicing, then a permanently operating form of leak detection shall be located at the most critical point to warn of a potentially hazardous situation.

2.2 Particular attention shall be paid to the following to ensure that by working on electrical components, the casing is not altered in such a way that the level of protection is affected.

This shall include damage to cables, excessive number of connections, terminals not made to original specification, damage to seals, incorrect fitting of glands, etc. Ensure that apparatus is mounted securely. Ensure that seals or sealing materials have not degraded such that they no longer serve the purpose of preventing the ingress of flammable atmospheres. Replacement parts shall be in accordance with the manufacturer's specifications.

NOTE:The use of silicon sealant may inhibit the effectiveness of some types of leak detection equipment. Intrinsically safe components do not have to be isolated prior to working on them.

3 REPAIR TO INTRINSICALLY SAFE COMPONENTS

Do not apply any permanent inductive or capacitance loads to the circuit without ensuring that this will not exceed the permissible voltage and current permitted for the equipment in use.

Intrinsically safe components are the only types that can be worked on while live in the presence of a flammable atmosphere. The test apparatus shall be at the correct rating. Replace components only with parts specified by the manufacturer. Other parts may result in the ignition of refrigerant in the atmosphere from a leak.

4 CABLING

Check that cabling will not be subject to wear, corrosion, excessive pressure, vibration, sharp edges or any other adverse environmental effects. The check shall also take into account the effects of aging or continual vibration from sources such as compressors or fans.

5 DETECTION OF FLAMMABLE REFRIGERANTS

Under no circumstances shall potential sources of ignition be used in the searching for or detection of refrigerant leaks. A halide torch (or any other detector using a naked flame) shall not be used.

6 LEAK DETECTION METHODS

The following leak detection methods are deemed acceptable for systems containing flammable refrigerants. Electronic leak detectors shall be used to detect flammable refrigerants, but the sensitivity may not be adequate, or may need recalibration. (Detection equipment shall be calibrated in a refrigerant-free area.) Ensure that the detector is not a potential source of ignition and is suitable for the refrigerant used. Leak detection equipment shall be set at a percentage of the LFL of the refrigerant and shall be calibrated to the refrigerant employed and the appropriate percentage of gas (25 % maximum) is confirmed. Leak detection fluids are suitable for use with most refrigerants but the use of detergents containing chlorine shall be avoided as the chlorine may react with the refrigerant and corrode the copper pipe-work. If a leak is suspected, all naked flames shall be removed/extinguished. If a leakage of refrigerant is found which requires brazing, all of the refrigerant shall be recovered from the system, or isolated (by means of shut off valves) in a part of the system remote from the leak. Oxygen free nitrogen (OFN) shall then be purged through the system both before and during the brazing process.

7 REMOVAL AND EVACUATION

When breaking into the refrigerant circuit to make repairs – or for any other purpose – conventional procedures shall be used. However, it is important that best practice is followed since flammability is a consideration. The following procedure shall be adhered to: remove refrigerant; purge the circuit with inert gas; evacuate; purge again with inert gas; open the circuit by cutting or brazing. The refrigerant charge shall be recovered into the correct recovery cylinders. The system shall be “flushed” with OFN to render the unit safe. This process may need to be repeated several times. Compressed air or oxygen shall not be used for this task. Flushing shall be achieved by breaking the vacuum in the system with OFN and continuing to fill until the working pressure is achieved, then venting to atmosphere, and finally pulling down to a vacuum.

This process shall be repeated until no refrigerant is within the system. When the final OFN charge is used, the system shall be vented down to atmospheric pressure to enable work to take place. This operation is absolutely vital if brazing operations on the pipework are to take place.

Ensure that the outlet for the vacuum pump is not close to any ignition sources and there is ventilation available.

8 CHARGING PROCEDURES

In addition to conventional charging procedures, the following requirements shall be followed.

- Ensure that contamination of different refrigerants does not occur when using charging equipment. Hoses or lines shall be as short as possible to minimise the amount of refrigerant contained in them.
- Cylinders shall be kept upright.
- Ensure that the refrigeration system is earthed prior to charging the system with refrigerant.
- Label the system when charging is complete (if not already).
- Extreme care shall be taken not to overfill the refrigeration system.

Prior to recharging the system it shall be pressure tested with OFN. The system shall be leak tested on completion of charging but prior to commissioning. A follow up leak test shall be carried out prior to leaving the site.

9 DECOMMISSIONING

Before carrying out this procedure, it is essential that the technician is completely familiar with the equipment and all its detail. It is recommended good practice that all refrigerants are recovered safely. Prior to the task being carried out, an oil and refrigerant sample shall be taken in case analysis is required prior to re-use of reclaimed refrigerant. It is essential that electrical power is available before the task is commenced.

- a) Become familiar with the equipment and its operation.
- b) Isolate system electrically.
- c) Before attempting the procedure ensure that :mechanical handling equipment is available, if required, for handling refrigerant cylinders; all personal protective equipment is available and being used correctly; the recovery process is supervised at all times by a competent person; recovery equipment and cylinders conform to the appropriate standards.
- d) Pump down refrigerant system, if possible.
- e) If a vacuum is not possible, make a manifold so that refrigerant can be removed from various parts of the system.
- f) Make sure that cylinder is situated on the scales before recovery takes place.
- g) Start the recovery machine and operate in accordance with manufacturer's instructions.
- h) Do not overfill cylinders. (No more than 80 % volume liquid charge).

- i) Do not exceed the maximum working pressure of the cylinder,even temporarily.
- j) When the cylinders have been filled correctly and the process completed, make sure that the cylinders and the equipment are removed from site promptly and all isolation valves on the equipment are closed off.
- k) Recovered refrigerant shall not be charged into another refrigeration system unless it has been cleaned and checked.

10 LABELLING

Equipment shall be labelled stating that it has been decommissioned and emptied of refrigerant. The label shall be dated and signed.

Ensure that there are labels on the equipment stating the equipment contains flammable refrigerant.

11 RECOVERY

When removing refrigerant from a system, either for servicing or decommissioning, it is recommended good practice that all refrigerants are removed safely. When transferring refrigerant into cylinders, ensure that only appropriate refrigerant recovery cylinders are employed. Ensure that the correct number of cylinders for holding the total system charge are available. All cylinders to be used are designated for the recovered refrigerant and labelled for that refrigerant (i.e. special cylinders for the recovery of refrigerant). Cylinders shall be complete with pressure relief valve and associated shut-off valves in good working order. Empty recovery cylinders are evacuated and, if possible, cooled before recovery occurs.

The recovery equipment shall be in good working order with a set of instructions concerning the equipment that is at hand and shall be suitable for the recovery of flammable refrigerants. In addition, a set of calibrated weighing scales shall be available and in good working order. Hoses shall be complete with leak-free disconnect couplings and in good condition. Before using the recovery machine, check that it is in satisfactory working order, has been properly maintained and that any associated electrical components are sealed to prevent ignition in the event of a refrigerant release. Consult manufacturer if in doubt.

The recovered refrigerant shall be returned to the refrigerant supplier in the correct recovery cylinder, and the relevant Waste Transfer Note arranged. Do not mix refrigerants in recovery units and especially not in cylinders.

If compressors or compressor oils are to be removed, ensure that they have been evacuated to an acceptable level to make certain that flammable refrigerant does not remain within the lubricant. The evacuation process shall be carried out prior to returning the compressor to the suppliers. Only electric heating to the compressor body shall be employed to accelerate this process. When oil is drained from a system, it shall be carried out safely.

COMPETENCE OF SERVICE PERSONNEL

General

Special training additional to usual refrigerating equipment repair procedures is required when equipment with flammable refrigerants is affected.

In many countries, this training is carried out by national training organisations that are accredited to teach the relevant national competency standards that may be set in legislation.

The achieved competence should be documented by a certificate.

Training

The training should include the substance of the following:

Information about the explosion potential of flammable refrigerants to show that flammables may be dangerous when handled without care.

Information about potential ignition sources, especially those that are not obvious, such as lighters, light switches, vacuum cleaners, electric heaters.

Information about the different safety concepts:

Unventilated – (see Clause GG.2) Safety of the appliance does not depend on ventilation of the housing. Switching off the appliance or opening of the housing has no significant effect on the safety. Nevertheless, it is possible that leaking refrigerant may accumulate inside the enclosure and flammable atmosphere will be released when the enclosure is opened.

Ventilated enclosure – (see Clause GG.4) Safety of the appliance depends on ventilation of the housing. Switching off the appliance or opening of the enclosure has a significant effect on the safety. Care should be taken to ensure a sufficient ventilation before.

Ventilated room – (see Clause GG.5) Safety of the appliance depends on the ventilation of the room. Switching off the appliance or opening of the housing has no significant effect on the safety. The ventilation of the room shall not be switched off during repair procedures.

Information about the concept of sealed components and sealed enclosures according to IEC 60079-15:2010.

Information about the correct working procedures:

a) Commissioning

- Ensure that the floor area is sufficient for the refrigerant charge or that the ventilation duct is assembled in a correct manner.
- Connect the pipes and carry out a leak test before charging with refrigerant.
- Check safety equipment before putting into service.

b) Maintenance

- Portable equipment shall be repaired outside or in a workshop specially equipped for servicing units with flammable refrigerants.
- Ensure sufficient ventilation at the repair place.
- Be aware that malfunction of the equipment may be caused by refrigerant loss and a refrigerant leak is possible.
- Discharge capacitors in a way that won't cause any spark. The standard procedure to short circuit the capacitor terminals usually creates sparks.

- Reassemble sealed enclosures accurately. If seals are worn, replace them.
- Check safety equipment before putting into service.

c) Repair

- Portable equipment shall be repaired outside or in a workshop specially equipped for servicing units with flammable refrigerants.
- Ensure sufficient ventilation at the repair place.
- Be aware that malfunction of the equipment may be caused by refrigerant loss and a refrigerant leak is possible.
- Discharge capacitors in a way that won't cause any spark.
- When brazing is required, the following procedures shall be carried out in the right order:
 - Remove the refrigerant. If the recovery is not required by national regulations, drain the refrigerant to the outside. Take care that the drained refrigerant will not cause any danger. In doubt, one person should guard the outlet. Take special care that drained refrigerant will not float back into the building.
 - Evacuate the refrigerant circuit.
 - Purge the refrigerant circuit with nitrogen for 5 min.
 - Evacuate again.
 - Remove parts to be replaced by cutting, not by flame.
 - Purge the braze point with nitrogen during the brazing procedure.
 - Carry out a leak test before charging with refrigerant.
 - Reassemble sealed enclosures accurately. If seals are worn, replace them.
 - Check safety equipment before putting into service.

d) Decommissioning

- If the safety is affected when the equipment is putted out of service, the refrigerant charge shall be removed before decommissioning.
- Ensure sufficient ventilation at the equipment location.
- Be aware that malfunction of the equipment may be caused by refrigerant loss and a refrigerant leak is possible.
- Discharge capacitors in a way that won't cause any spark.
- Remove the refrigerant. If the recovery is not required by national regulations, drain the refrigerant to the outside. Take care that the drained refrigerant will not cause any danger. In doubt, one person should guard the outlet. Take special care that drained refrigerant will not float back into the building.
- Evacuate the refrigerant circuit.
- Purge the refrigerant circuit with nitrogen for 5 min.
- Evacuate again.
- Fill with nitrogen up to atmospheric pressure.
- Put a label on the equipment that the refrigerant is removed.

e) Disposal

- Ensure sufficient ventilation at the working place.
- Remove the refrigerant. If the recovery is not required by national regulations, drain the refrigerant to the outside. Take care that the drained refrigerant will not cause any danger. In doubt, one person should guard the outlet. Take

special care that drained refrigerant will not float back into the building.

- Evacuate the refrigerant circuit.
- Purge the refrigerant circuit with nitrogen for 5 min.
- Evacuate again.
- Cut out the compressor and drain the oil.

Transportation, marking and storage for units that employ flammable refrigerants

Transport of equipment containing flammable refrigerants

Attention is drawn to the fact that additional transportation regulations may exist with respect to equipment containing flammable gas. The maximum number of pieces of equipment or the configuration of the equipment, permitted to be transported together will be determined by the applicable transport regulations.

Marking of equipment using signs

Signs for similar appliances used in a work area generally are addressed by local regulations and give the minimum requirements for the provision of safety and/or health signs for a work location.

All required signs are to be maintained and employers should ensure that employees receive suitable and sufficient instruction and training on the meaning of appropriate safety signs and the actions that need to be taken in connection with these signs.

The effectiveness of signs should not be diminished by too many signs being placed together.

Any pictograms used should be as simple as possible and contain only essential details.

Disposal of equipment using flammable refrigerants

See national regulations.

Storage of equipment/appliances

The storage of equipment should be in accordance with the manufacturer's instructions.

Storage of packed (unsold) equipment

Storage package protection should be constructed such that mechanical damage to the equipment inside the package will not cause a leak of the refrigerant charge.

The maximum number of pieces of equipment permitted to be stored together will be determined by local regulations.

- Disconnect the appliance from its power source during service and when replacing parts and cleaning.
- Please note: Check the nameplate for the type of refrigerant gas used in your

appliance.

- Specific information regarding appliances with refrigerant gas.

The appliance is recommended not to pierce the cooling circuit of the machine. At the end of its useful life, deliver the appliance to a special waste collection centre for disposal.

GWP(Global Warming Potential): R410A: 2088, R134a: 1430, R290: 3, R32: 675.

- Do not use this unit for functions other than those described in this instruction manual.
- Make sure the plug is plugged firmly and completely into the outlet. It can result in the risk of electric shock or fire.
- Do not plug other appliances into the same outlet, it can result in the risk of electric shock.
- Do not disassemble or modify the appliance or the power cord, it can result in the risk of electric shock or fire. All other services should be referred to a qualified technician.
- Do not place the power cord or appliance near a heater, radiator, or other heat source. It can result in the risk of electric shock or fire.
- This unit is equipped with a cord that has a earthed wire connected to an earthed pin or grounding tab. The plug must be plugged into a socket that is properly installed and earthed. Do not under any circumstances cut or remove the earthed pin or grounding tab from this plug.
- The unit should be used or store in such a way that it is protected from moisture e.g. condensation, splashed water, etc. Unplug unit immediately if this occurs.
- Always transport your appliance in a vertical position and place on a stable, level surface during use. If the unit is transported laying on its side it should be stood up and left unplugged for 6 hours.
- Always use the switch on the control panel or remote controller to turn the unit off, and do not start or stop operation by plugging in or unplugging the power cord. It can result in the risk of electric shock.
- Do not touch the buttons on the control panel with your wet and damp fingers.
- Do not use hazardous chemicals to clean or come into contact with the unit. To prevent damage to the surface finish, use only a soft cloth to clean the appliance. Do not use wax, thinner, or a strong detergent. Do not use the unit in the presence of inflammable substance or vapour such as alcohol, insecticides, gasoline, etc.
- If the appliance is making unusual sounds or is emitting smoke or an unusual odor, unplug it immediately.
- Do not clean the unit with water. Water can enter the unit and damage the insulation, creating a shock hazard. If water enters the unit, unplug it immediately and contact Customer Service.
- Utilize two or more people to lift and install the unit.
- Always grasp the plug when plugging in or unplugging the appliance. Never

unplug by pulling on the cord. It can result in the risk of electrical shock and damage.

- Install the appliance on a sturdy, level floor capable of supporting up to 110lbs(50kg). Installation on a weak or unlevel floor can result in the risk of property damage and personal injury.
- The appliance is compliant with the RE Directive (2014/53/EU).

According the EN standard:

- This appliance can be used by children aged from 8 years and above and persons with reduced physical, sensory or mental capabilities or lack of experience and knowledge if they have been given supervision or instruction concerning use of the appliance in a safe way and understand the hazards involved.
- Children shall not play with the appliance.
- Cleaning and user maintenance shall not be made by children without supervision.
- If the supply cord is damaged, it must be replaced by the manufacturer, its service agent or a similarly qualified person in order to avoid a hazard.
- The appliance shall be installed in accordance with national wiring regulations.
- When the fuse is blown/circuit breaker is tripped, check the house fuse/circuit breaker box and replace fuse or reset breaker.

ELECTRICAL CONNECTIONS

Before plugging the appliance into the mains socket, check that:

- The mains power supply corresponds to the value indicated on the rating plate on the back of the appliance.
- The power socket and electrical circuit are adequate for the appliance.
- The mains socket matches the plug. If this is not the case, have the plug replaced.
- The mains socket is adequately earthed. Failure to follow these important safety instructions absolves the manufacturer of all liability.

SOME NOTIONS ON HUMIDITY

Air always contains a certain amount of water in the form of vapour. This determines the level of humidity in an atmosphere. The capacity of the air to hold water vapour increases with temperature. This is why in our homes, as soon as the temperature decreases, the vapour contained in the air condenses, as is evident on the colder surfaces in the room, such as the windows, walls etc. The purpose of a dehumidifier is to remove the excess moisture from the air, avoiding the damage caused by condensation.

Experts have established that the optimum environmental conditions for our well being and for the home are obtained between 40% and 60% relative humidity. With very low temperatures, you are recommended to heat the room even minimally. This considerably increases the dehumidifying power of the appliance. With heating, the condensation formed by the water vapour on windows and other cold surfaces evaporates into the air to be collected by the dehumidifier. Air leaving the dehumidifier is usually about 1□-2□ warmer than room temperature.

DESCRIPTION

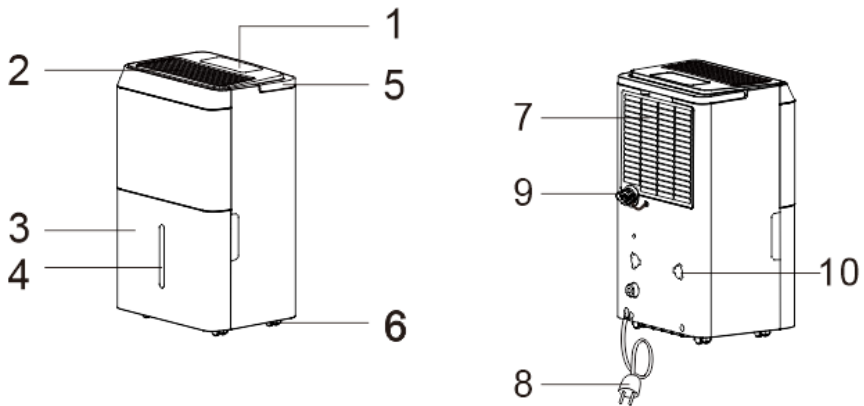

Component Description

1. Control panel	6. Castor
2. Air outlet	7. Air intake grille
3. Bucket	8. Power cord
4. Water level view window	9. Drain port
5. Handle	10. Holes of Hooks

NOTE: All the illustrations in this manual are for explanatory purposes only. your appliance may be slightly different.

Before use, remove the accessory from the bucket

- Remove the bucket from appliance.
- Take out of the the plug and other accessories.
- Correctly put back the bucket into the appliance.

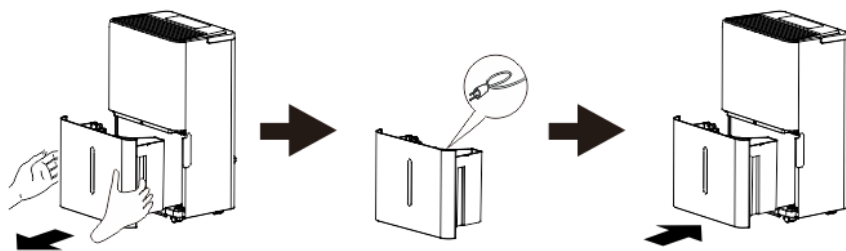

The accessories are include:

	Drain pipe	1 set
---	------------	-------

NOTE: All the illustrations in this manual are for explanatory purposes only. your appliance may be slightly different.
Be sure all accessories are removed from the packing and bucket before use.

DESCRIPTION OF THE DISPLAY SCREEN AND CONTROL PANEL

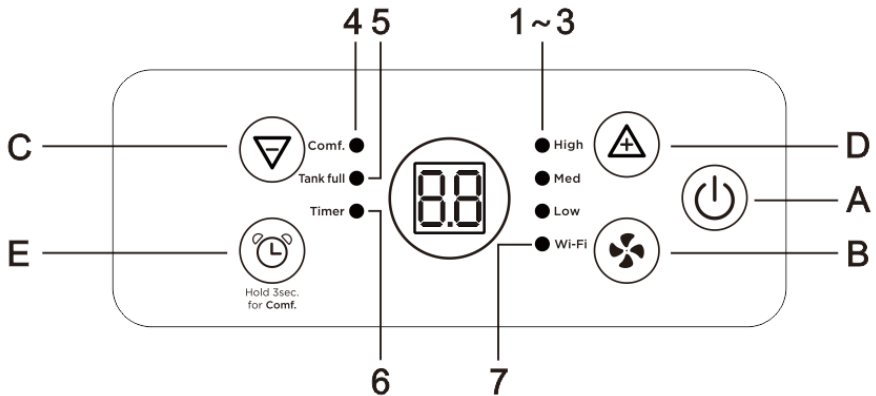

A. On / Off button	1. High speed symbol	5. Tank full symbol
B. Fan speed button	2. Med speed symbol	6. Timer symbol
C. Decrease button	3. Low speed symbol	7. Wi-Fi symbol**
D. Increase button	4. Comfort symbol	
E. Timer button		



Note: “ * ” The Wi-Fi is an optional function.



Note: Hold the  button and  button 5 seconds, active the Wi-Fi function, please follow the Wi-Fi manual to connect. When the unit is connected with phone, the Wi-Fi symbol is light on.

- “  ” button

- On / off power supply, used to control the start-up or shut down the appliance.

- **Decrease / Increase button**



- Press “  ” / “  ” to select the indoor humidity level you expect to achieve, or set the time.

- Press the “  ” button until the “  ” on screen, then the unit will continuously run.

● "  " button:

- Press the "  " button to choose different fan speed, and corresponding symbol will be light.

* Comfort mode

- Hold the "  " 3 seconds, the "  " symbol is lights, the appliance will setting humidity according the ambient temperature. So the humidity can not be adjusted and show the ambient humidity.

- The fan speed is low and can not be adjusted.

- When active the comfort mode, the screen light will go to dim , after 1 minute later the screen will turn off.

- Press other button to check the status, the screen will light again and after 1 minute later will turn off.



- Press the "  " button or hold "  " button 3 seconds to quit the Comfort mode.

●  **Timer button**

This timer can be used to delay the appliance start-up or shutdown, this avoids wasting electricity by optimizing operating periods.

* **Programming start-up**

- Turn on the appliance, choose the mode you want, for example Dry mode, 65%RH. Turn off the appliance.



- Press the "  " button , the screen starts to flash, press the "  " or "  " until the corresponding time is displayed..

- In 5 seconds without the operation, the timer start function, then the "Timer" symbol lights.

- The control will count down the time remaining until start-up.

- Press the "  " button again to cancel the Timer, and the "Timer " symbol disappear.

* **Programming shut down**

- When the appliance is running, press the "  " button, the screen starts to flash, press the "  " or "  " until the corresponding time is displayed..

- In 5 seconds without the operation, the timer start function, then the " Timer"

symbol lights.

- Press the "  " button again to cancel the Timer, and the " Timer " symbol disappear.

● ALARM OF BUCKET FULL

- When bucket is full, the compressor will shut off, the fan will stop for a few minutes , and make a beeping noise, " Tank Full " symbol is flashing.
- The unit will not run again until the bucket is emptied and properly placed back inside the unit.
- The bucket should be cleaned every week to prevent the growth of mold, mildew and bacteria. Use a mild detergent to clean. Once clean, completely dry the bucket and place it back inside unit.

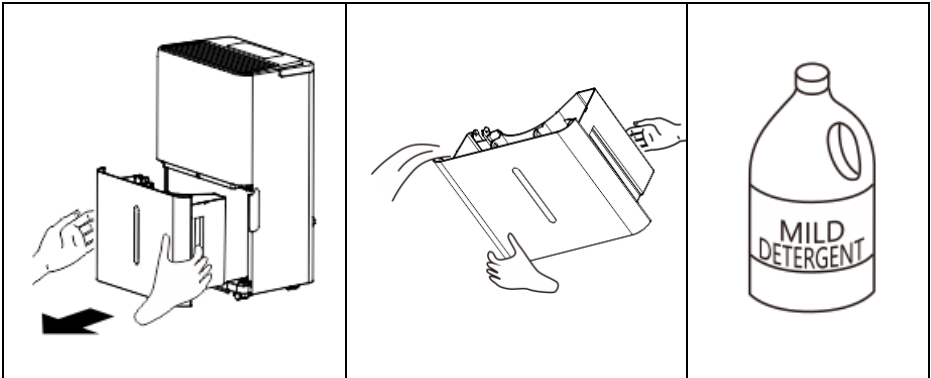

NOTE: Hold the bucket with both hands when emptying.

NOTE: When the bucket is full or removed from the unit, the compressor will turn off but the fan will continue to run for a few minutes. This is completely normal. The unit will not be removing moisture from the air at this time.

NOTE: During operation, it is normal for the unit to exhaust warm air from the top of the unit.

CAUTION: Do not place the bucket on the floor when it is full as it is uneven on the bottom and water may spill.

● Continuous drain

Connect the drain pipe on the back of unit, then the unit can continuous run without clean the bucket.

- Put the unit on level floor, unscrew the cap on the back of unit;
- Install the drain pipe on connector;

- Press "  " button to run the unit.

NOTE: If no need the function of continuous drain, please install the cap on the drain hole back of unit, then the water will flow into bucket.

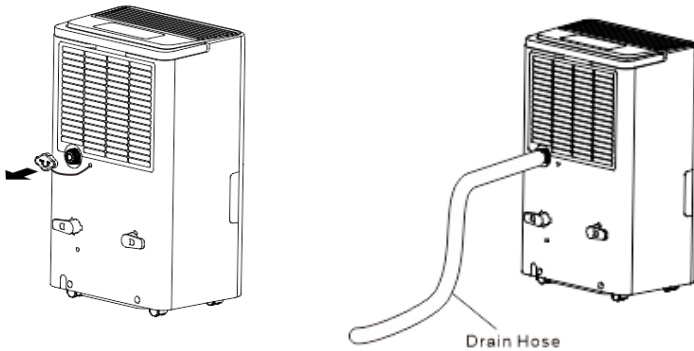

NOTE: Please install the drain pipe follow below picture.

Please install the drain pipe correctly, or the water cannot drain from the pipe.

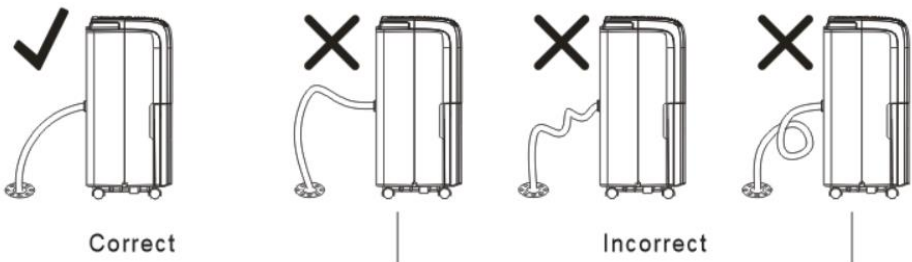

NOTE: If the unit put on the un-level ground or not correctly install the drain pipe, the water will full the bucket and stop run.

If that happened, please check the ground is whether horizon, and the drain pipe is correctly installed.

At the same time, the bucket need to be install correctly.

● AUTOMATIC DEFROST

When frost builds up on the evaporator coils, the compressor will stop and the fan will continue to run until the frost disappears. When the coils are completely defrosted, the compressor will automatically restart and dehumidify will resume.

LOCATION REQUIREMENTS:

The unit operating in a basement will have little no effect in drying out an adjacent enclosed storage area, such as a closet, unless there is adequate circulation of air in and out of the area.

1. Do not use outdoors.
 2. This appliance is intended for indoor use only. Place the appliance on a smooth, level floor surface that is strong enough to support the unit with a full bucket of water.
 3. Allow at least 18" (45cm) of around and above space away from the wall for efficient working.
 4. Place the appliance in an area where the temperature will not fall 5° (41°).
 5. Use the dehumidifier in cooking, laundry, bathing and dish-washing areas that have excessive moisture.
 6. Place the dehumidifier away from a clothes dryer.
 7. Use the dehumidifier in a basement to help prevent moisture damage.
 8. The dehumidifier must be operated in an enclosed area to be most effective, close all doors, windows and other outside openings to the room.
 9. Do not block the air inlet or outlet of the appliance.
- Reduced air flow will result in poor performance and could damage the unit.

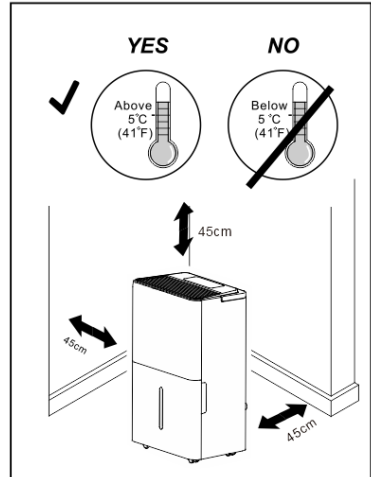

CLEAN AND MAINTENANCE

Before cleaning or maintenance, turn the appliance off by pressing the “POWER” button on the control panel, wait for a few minutes then unplug from the mains socket.

CLEANING THE CABINET

You should clean the appliance with a slightly damp cloth then dry with a dry cloth.

- Never wash the appliance with water, it could be dangerous.
- Never use petrol, alcohol or solvents to clean the appliance.
- Never spray insecticide liquids or similar.

CLEANING THE FILTER

- To keep your appliance working efficiently, you should clean the filter every month of operation.
- The filter can take out like fig.
- To avoid possible cuts, avoid contacting the metal parts of the appliance when removing or re-installing the filter.

It can result in the risk of personal injury.

- Use a vacuum cleaner to remove dust accumulations from the filter. If it is very dirty, immerse in warm water and rinse a number of times. The water should never be hotter than 40°C(104°F). After washing, leave the filter to dry then attach the intake grille to the appliance.

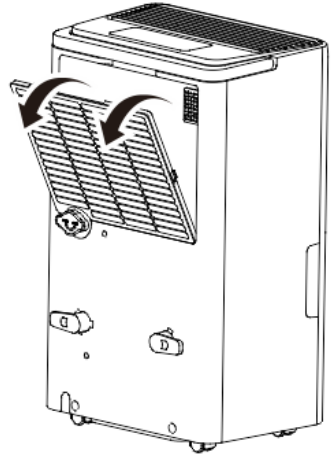

END OF SEASON OPERATIONS

- To unplug from the mains socket, empty the bucket, remove the cap.
- Run off all water left inside the appliance. When all the water has been drained, put the cap back in place.
- Clean the filter and dry thoroughly before putting back.
- Cover the appliance prevent from dust.
- Store the appliance upright in a dry location.

START OF SEASON CHECKS

Make sure the power cable and plug are undamaged and the earth system is efficient.

Follow the installation instructions precisely.

TROUBLESHOOTING

Occasionally, you may encounter some problems that are of a minor nature and a service call may not be necessary. Use this troubleshooting guide to identify possible problems you may be experiencing.

Problem	Possible Causes	Solutions
Dehumidifier does not start	The dehumidifier is unplugged.	Make sure the dehumidifier's plug is pushed completely into the outlet.
	The fuse is blown/circuit breaker is tripped.	Check the house fuse/circuit breaker box and replace fuse or reset breaker.
	Dehumidifier has reached its present level or the bucket is full.	The dehumidifier automatically turns off when either condition occurs. Change to a lower setting or empty the water bucket and replace properly.
	Bucket is not in the proper position.	The bucket must be in place and securely seated for the dehumidifier to operate.
	Power Failure.	There is a protective time delay (up to 3 min.) to prevent tripping of the compressor overload. For this reason, the unit may not start normal dehumidify for 3 min after it is powered back on.
Dehumidifier does not dry the air as it should	Not enough time allowed for unit to remove moisture.	When first installed, allow at least 24 hours to maintain the desired dryness.
	Airflow is restricted.	Make sure there are no curtains, blinds, or furniture blocking the front or back of the dehumidifier. See the CHOOSING A LOCATION section.
	Dirty filter.	See the CLEAN FILTER section.

	The Humidity Control may not be set low enough.	For drier air, press the “ - ” button to lower the percent humidity desired in the room, or set the dehumidifier to Cont. for maximum dehumidify.
	Doors and windows may not be closed tightly.	Check that all doors, windows, and other openings are securely closed.
	Clothes dryer may be blowing moist air into the room.	Install the dehumidifier away from the dryer. The dryer should be vented outside.
	Room temperature is too low.	Moisture removal is best at higher room temperatures. Lower room temperatures will reduce the moisture removal rate. This model is designed to operate at temperatures above 50(41).
Appliance runs too long	The area is too large	The capacity of the appliance can not meet the area of the room
	Doors and windows are open	Close the door and window
Frost appears on heat-exchanger	Appliance run recently or the room temperature is too low	It is normal, frost usually disappear in 60 min
Fan noise	The air is passing through the appliance	This is normal
Water on the floor	The drain connection may be aging or loose	Check the drain connection and the appliance is placed level
	The drain pipe is connected, but the water is not drained.	If use the bucket, remove the drain pipe and put back the drain cover; or install the drain pipe correctly

If the following error code appears, contact the after-sales service department for inspection and repair.

Code	Description	Possible Causes	Solutions
EH	Humidity sensor failure	Humidity sensor is damaged.	Connect customer service center.
E1	Temperature sensor failure	Temperature sensor is damaged.	Connect customer service center.
E2			
E3	Gas leakage	Gas is leak.	Connect customer service center.

Strictest operation environment: 5℃~32℃ (41℉~90℉) ,30%RH~90%RH.

