

Panasonic®

Operating Instruction and Cook Book Microwave Oven Household Use Only

INVERTER

Model No. NN-SD38HS



**Please read these instructions carefully before using this product,
and save this manual for future use.**

We are glad you have chosen to purchase a PANASONIC microwave oven. Before operating this oven, please read these instructions carefully and completely, and keep them for further reference.

If you have only used a microwave oven for reheating and defrosting, with Panasonic's Inverter Technology you can be reassured of excellent results when cooking a variety of foods, as the 'soft' penetration of microwave energy to the centre of food helps prevent over cooking on edges and surfaces. Foods can now be gently simmered without the concern of boil over.

After reading the introductory chapter, we are sure you will be able to master the basic techniques and thereby develop a firm understanding of your new oven. This book includes recipes from starters to desserts. After trying our recipes be sure to adapt your favourite recipes to microwave methods.

Start experimenting now, and enjoy the first class results you will achieve by using your new microwave oven.

Panasonic Australia Pty Ltd
1 Innovation Road
Macquarie Park
NSW 2113



Panasonic NZ Ltd
Customer Care Centre
18 Sir Woolf Fisher Drive
Highbrook, Auckland
Private Bag 14911
Panmure, Auckland

Phone: (09) 272 0178
Fax: (09) 272 0129

The serial number of this product may be found on the back side of the oven. You should note the model number and serial number of this oven in the space provided and retain this book as a permanent record of your purchase for future reference.

MODEL NUMBER _____

SERIAL NUMBER _____

DATE OF PURCHASE _____

Table of Contents

Before Operation

Important Safety Instructions.....	6-7
Installation and General Instructions	7-8
Microwaves and How They Work.....	9
Cookware and Utensils Guide.....	9-10
Feature Diagram	11
Control Panel.....	12
Ingredient Conversion Chart	23

Operation and Hints

Quick Guide to Operation.....	4-5
Let's Start To Use Your Oven	13
To Use Child Safety Lock	13
To Set Clock	14
Dial Features	14
To Cook on Micro Power by Time Setting	15
To Defrost on Micro Power by Time Setting	16
To Defrost using Turbo Defrost.....	16-17
To Cook using the Quick 30 Feature	18
To using the Add Time Feature.....	18
To Cook/Reheat Food Using Auto Menus	19-21
Melt & Soften Feature	22
Keep Warm Feature	22
3-Stages Setting.....	23
To Use Timer	24
Defrosting Chart.....	25
Reheating Chart.....	26
Cooking Chart	27







Cooking Guide

Microwave Recipe Techniques.....	28-30
Basic Recipes.....	31
Soups and Snacks	32-33
Fish and Shellfish.....	34-35
Poultry	36-37
Main Fare Meats	38-40
Vegetable Varieties.....	41-44
Rice, Pasta and Cereal	45-46
Desserts	47





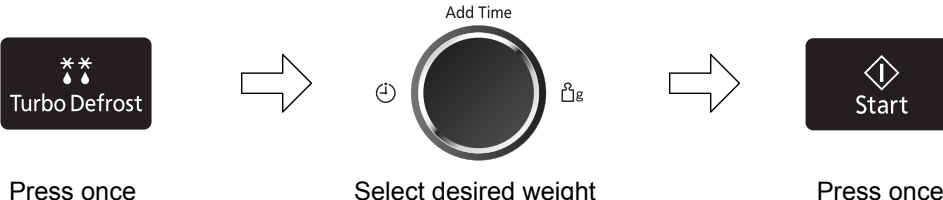
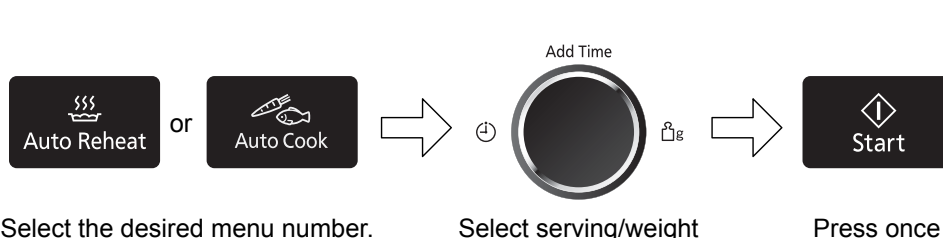
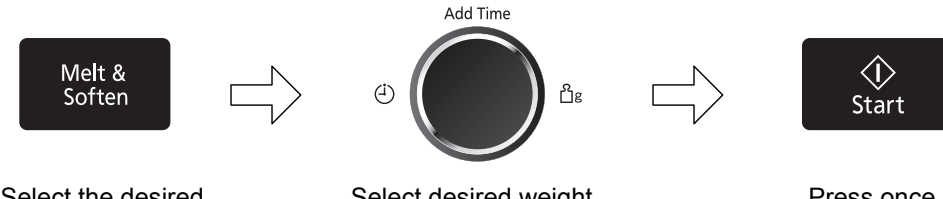







Maintenance

Before Requesting Service.....	48
Care of Your Microwave Oven.....	49
Technical Specifications	50
Panasonic Warranty	51

Quick Guide to Operation

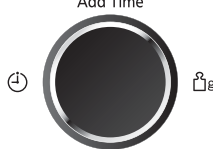
Feature	How to Operate
To Set Clock (page 14)	 <p>Press twice Set time of day Press once</p>
To Set / Cancel Child Safety Lock (page 13)	<p>To set:</p>  <p>Press 3 times.</p> <p>To cancel:</p>  <p>Press 3 times.</p>
To Cook/Reheat/ Defrost by Micro Power and Time Setting (page 15)	 <p>Select power. set the cooking time. Press once</p>
To Use Turbo Defrost Button (page 16)	 <p>Press once Select desired weight Press once</p>
To Reheat / Cook Food using “Auto Reheat / Cook” Buttons (page 19)	 <p>Select the desired menu number. Select serving/weight Press once</p>
To use Melt&Soften Button (page 22)	 <p>Select the desired menu number. Select desired weight Press once</p>
To use “Keep Warm” Button (page 22)	 <p>Press once Select Keep Warm time. Press once</p>

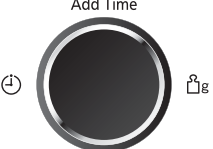
Quick Guide to Operation (continued)

<p>To Cook using Quick 30 Button (page 18)</p>	 →  Press to set the desired cooking time. Press once
<p>To Use the Add Time Feature (page 18)</p>	 →  After cooking, turn dial to select Add Time feature Press once
<p>To Use as a Kitchen Timer (page 24)</p>	 →  →  Press once Set the kitchen time. Press once
<p>To Set Standing Time (page 24)</p>	Set the desired cooking programme. →  →  Press once Set the standing time ↓  Press once
<p>To Set Delay Start (page 24)</p>	 →  → Set the desired cooking programme. Press once Set the delay time. ↓  Press once

Important Safety Instructions

READ CAREFULLY AND KEEP FOR FUTURE REFERENCE

Precautions To Be Taken When Using Microwave Ovens For Heating Foodstuffs

INSPECTION FOR DAMAGE:

A microwave oven should only be used if an inspection confirms all of the following conditions:

1. The door fits squarely and securely and opens and closes smoothly.
2. The door hinges are in good condition.
3. The metal plates of a metal seal on the door are neither buckled nor deformed.
4. The door seals are neither covered with food nor have large burn marks.

PRECAUTIONS:

Microwave radiation from microwave ovens can cause harmful effects if the following precautions are not taken:

1. Never tamper with or deactivate the interlocking devices on the door.
2. Never poke an object, particularly a metal object, through a grille or between the door and the oven while the oven is operating.
3. Never place saucepans, unopened cans or other heavy metal objects in the oven.
4. Do not let other metallic articles, e.g. fast food foil containers, touch the side of the oven.
5. Clean the oven cavity, the door and the seals with water and a mild detergent at regular intervals. Never use any form of abrasive cleaner that may scratch or scour surfaces around the door.
6. Always use the oven with the trays or cookware recommended by the manufacturer.
7. Never operate the oven without a load (i.e. an absorbing material such as food or water) in the oven cavity unless specifically allowed in the manufacturer's literature.
8. For horizontally hinged doors, never rest heavy objects such as food containers on the door while it is open.
9. Do not place sealed containers in the microwave oven. Baby bottles fitted with a screw cap or a teat are considered to be sealed containers.
10. This appliance is not intended for use by persons (including children) with reduced physical, sensory or mental capabilities, or lack of experience and knowledge, unless they have been given supervision or instruction concerning use of the appliance by a person responsible for their safety.
11. Children should be supervised to ensure that they do not play with the appliance.
12. It is hazardous for anyone other than a competent person to carry out any service or repair operation that involves the removal of a cover which gives protection against exposure to microwave energy.
13. The surfaces are liable to get hot during use.

Important Instructions

WARNING—To reduce the risk of burns, electric shock, fire, injury to persons or excessive microwave energy:

1. Read all instructions before using the microwave oven.
2. Some products such as whole eggs and sealed containers - (for example, closed glass jars **and sealed baby bottles with teat**) - may explode and should not be heated in the microwave oven.
3. Use this microwave oven only for its intended use as described in this manual.
4. As with any appliance, close supervision is necessary when used by children.
5. Do not operate this microwave oven, if it is not working properly, or if it has been damaged or dropped.
6. Do not store or use this appliance outdoors.
7. Do not immerse cord or plug in water.
8. Keep cord away from heated surfaces.
9. Do not let cord hang over edge of table or counter.
10. To reduce the risk of fire in the oven cavity:
 - (a) Do not overcook food. Carefully attend microwave oven if paper, plastic, or other combustible materials are placed inside the oven to facilitate cooking.
 - (b) Heating therapeutic wheat bags is not recommended. If heating, do not leave unattended and follow manufacturers' instructions carefully.
 - (c) Remove wire twist-ties from bags before placing bag in oven.
 - (d) If materials inside the oven should ignite, keep oven door closed, turn oven off at the wall switch, or shut off power at the fuse or circuit breaker panel.
 - (e) Never leave microwave unattended while cooking or reheating.
11. Do not remove outer panel from oven.
12. Appliances are not intended to be operated by means of an external timer or separate remote-control system.
13. Failure to maintain the oven in a clean condition could lead to deterioration of the surface that could adversely affect the life of the appliance and possibly result in a hazardous situation.

Circuits

Your microwave oven should be operated on a separate 10 A circuit from other appliances. Failure to do this may cause the power board fuse to blow, and/or food to cook slower. Do not insert higher value fuse in the power board.

Important Safety Instructions (continued)

Earthing Instructions

This microwave oven must be earthed. In the event of an electrical short circuit, earthing reduces the risk of electric shock by providing an escape wire for the electric current. This microwave oven is equipped with a cord having an earthing wire with an earthing plug. The plug must be plugged into an outlet that is properly installed and earthed.

Fan Motor Operation after Cooking

After using this oven the fan may rotate to cool the electric components. This is perfectly normal, and you can take out the food from the oven while the fan operates.

WARNING—Improper use of the earthing plug can result in a risk of electric shock.

WE CERTIFY THAT THIS MICROWAVE OVEN HAS BEEN INSPECTED AND COMPLIES WITH THE REQUIREMENTS OF REGULATION 3, SUBCLAUSE(2), OF THE MICROWAVE OVENS REGULATIONS 1982.

(This statement applicable only to New Zealand.)

We certify that this microwave oven has been inspected and complies with the safety requirements of government notice 466 of March 1981, and complies with the Radio Regulation of government notice 587 of March 1986.

(This statement applicable only to South Africa)

WARNING

- a) The door seals and door seal areas should be cleaned with a damp cloth. The appliance should be inspected for damage to the door seals and door seal areas and if these areas are damaged the appliance should not be operated until it has been repaired by a qualified service technician trained by the manufacturer.
- b) If the door or door seals are damaged, the oven must not be operated until it has been repaired by a competent person.
- c) It is hazardous for anyone other than a competent person to carry out any service or repair operation that involves the removal of a cover which gives protection against exposure to microwave energy.
- d) If the supply cord is damaged, it must be replaced by the manufacturer, its service agent or similarly qualified persons in order to avoid a hazard.
- e) Before use, the user should check that whether the utensils are suitable for use in microwave ovens.
- f) Liquids and other foods must not be heated in sealed containers since they are liable to explode.
- g) Only allow children to use the oven without supervision when adequate instructions have been given so that the child is able to use the oven in a safe way and understands the hazards of improper use.

Installation and General Instructions

General Use

1. In order to maintain high quality, do not operate the oven when empty. The microwave energy will reflect continuously throughout the oven if no food or water is present to absorb energy. This can lead to damage to the microwave oven including arcing within the oven cavity.
2. If smoke is observed, press the **STOP/RESET** Button and leave door closed in order to stifle any flames. Disconnect the power cord, and/or shut off power at the fuse or circuit breaker panel.
3. Do not dry clothes, newspapers or other materials in oven. They may catch on fire.
4. Do not use recycled paper products, unless the paper product is labelled as safe for microwave oven use. Recycled paper products may contain impurities which may cause sparks and/or fires when used.
5. Do not use newspapers or paper bags for cooking.
6. Do not hit or strike the Control Panel. Damage to controls may occur.
7. **POT HOLDERS** may be needed as heat from food is transferred to the cooking container and from the container to the Glass Tray. The Glass Tray can be very hot after removing the cooking container from the oven.
8. Do not store flammable materials next to, on top of, or in the oven. It could be a fire hazard.
9. Do not cook food directly on Glass Tray unless indicated in recipes. (Food should be placed in a suitable cooking utensil.)
10. **DO NOT** use this oven to heat chemicals or other non-food products. **DO NOT** clean this oven with any product that is labelled as containing corrosive chemicals. **The heating of corrosive chemicals in this oven may cause microwave radiation leaks.**
11. If glass tray is hot, allow to cool before cleaning or placing in water.
12. During cooking, some steam will condense inside and/or on the oven door. This is normal and safe. Steam will disappear after the oven cools down.

Installation and General Instructions (continued)

13. Do not leave the microwave unattended while reheating or cooking food in disposable containers made of plastic, paper or other combustible materials, as these types of containers can ignite if overheated.
14. The microwave oven is intended for heating food and beverages. Drying of food or clothing and heating of warming pads, slippers, sponges, damp cloth and similar may lead to risk of injury, ignition or fire.
15. Metallic containers for food and beverages are not allowed during microwave cooking.
16. Only use utensils that are suitable for use in microwave ovens.

Placement of Oven

1. The oven must be placed on a flat, stable surface. For correct operation, the oven must have sufficient air flow. **Allow more than 15 cm of space on the top of the oven, 10 cm at the back, and 5 cm on both sides. If one side of the oven is placed flush to wall, the other side or top must not be blocked. Do not remove feet.**
 - (a) Do not block air vents. If they are blocked during operation, the oven may be overheated and damaged. When using any cloth over the oven, the air intake and exhaust should not be blocked. Also allow sufficient space on back and both sides of the oven.
 - (b) Do not place oven near a hot or damp surface such as a gas stove, electric range or sink etc.
 - (c) Do not operate oven when room humidity is too high.
2. This oven was manufactured for household use only.
3. The appliance must not be placed in a cabinet.

Food

1. Do not use your oven for home canning or the heating of any closed jar. Pressure will build up and the jar may explode. In addition, the microwave oven cannot maintain the food at the correct canning temperature. Improperly canned food may spoil and be dangerous to consume.
2. Do not attempt to deep fat fry in your microwave oven.
3. Eggs in their shell and whole hard-boiled eggs should not be heated in microwave ovens since they may explode, even after microwave heating has ended.
4. Potatoes, apples, egg yolks, chicken wings, whole squash and sausages are examples of foods with nonporous skins. This type of food must be pierced before cooking, to prevent bursting.
5. When heating liquids, e.g. soup, sauces and

beverages, in your microwave oven, overheating the liquid beyond boiling point can occur without evidence of bubbling. This could result in a sudden boil over of hot liquid. To prevent this possibility the following steps should be taken:

- (a) Avoid using straight-sided containers with narrow necks.
 - (b) Do not overheat.
 - (c) Stir the liquid before placing the container in the oven and halfway through cooking time.
 - (d) After heating, allow to stand in the oven for a short time, stirring again before carefully removing the container.
 - (e) Microwave heating of beverages can result in delayed eruptive boiling, therefore care should be taken when handling the container.
6. **DO NOT USE A CONVENTIONAL MEAT THERMOMETER IN THE MICROWAVE OVEN. To check the degree of cooking of roasts and poultry use a MICROWAVE THERMOMETER.** Alternatively, a conventional meat thermometer may be used after the food is removed from the oven. If undercooked, return meat or poultry to the oven and cook for a few more minutes at the recommended power level. It is important to ensure that meat and poultry are thoroughly cooked.
 7. **COOKING TIMES given in the Cooking Guide section are APPROXIMATE.** Factors that may affect cooking time are preferred degree of moisture content, starting temperature, altitude, volume, size, shape of food and utensils used. As you become familiar with the oven, you will be able to adjust for these factors.
 8. **It is better to UNDERCOOK RATHER THAN OVERCOOK foods.** If food is undercooked, it can always be returned to the oven for further cooking. If food is overcooked, nothing can be done. Always start with minimum cooking times recommended.
 9. Extreme care should be taken when cooking popcorn in a microwave oven. Cook for minimum time as recommended by manufacturer. Use the directions suitable for the wattage of your microwave oven. NEVER leave oven unattended when popping popcorn.
 10. When heating food in plastic or paper containers, keep an eye on the oven due to the possibility of ignition.
 11. The contents of feeding bottles and baby food jars shall be stirred or shaken and the temperature checked before consumption, in order to avoid burns.

Microwaves and How They Work

Microwaves are a form of high frequency radio waves similar to those used by a radio, including AM, FM and CB. They are similar to a television where the radio waves are converted to a picture on the screen. However, microwaves are much shorter than radio waves; approximately twelve centimetres wave length. Electricity is converted into microwave energy by the magnetron tube (which is the heart of the microwave oven).

From the magnetron tube, microwave energy is transmitted to the oven cavity through a small plastic covered piece. The microwaves are converted to heat in the food. The microwaves enter from the outside of the food and travel through the food losing half of their power every two to three centimetres. Continued cooking to the centre occurs by conduction.

Although pacemakers used to be affected by microwaves (as well as by other radio waves), they are now shielded and are not bothered by these interferences. This allows people with pacemakers to sit calmly by their radio or television and cook with microwave ovens.

When microwaves come in contact with a substance, any one or combination of three things may occur.

They can be:

1. REFLECTED
2. TRANSMITTED
3. ABSORBED

Reflection:

Metal substances REFLECT microwave energy and because there is no absorption, there is no heating. This is why the oven interior is either stainless steel or epoxy-coated steel. This ensures that the microwaves are kept inside the cavity and evenly distributed throughout the food with the help of the glass tray.

Transmission:

Such substances as paper, glass and plastic TRANSMIT microwave energy and do not become hot except from food. Because these substances do not reflect or absorb microwave energy, they are ideal materials for microwave cooking containers.

Absorption:

Food contains moisture and will ABSORB microwave energy, which causes the moisture molecules within the food to vibrate at an incredible rate (2,450,000,000 times per second). Friction, created by the vibration, produces heat energy which is conducted throughout the food.

Cookware and Utensils Guide

It is important to use the correct container when cooking in a microwave oven. The following will help you make the right selection.

Metallic containers for food and beverages are not allowed during microwave cooking.

How to Test a Container for Safe Microwave Oven Use

TO TEST A CONTAINER FOR SAFE MICROWAVE OVEN USE: Fill a 1-cup glass measure with cool water and place it in the microwave oven alongside the empty container to be tested; **heat one (1) minute at 1000 W**. If the container is microwave oven safe (transparent to microwave energy), the container should remain comfortably cool, the water in glass measure should be hot. If the container is hot, it has absorbed some microwave energy and should NOT be used. This test cannot be used for plastic containers.

Paper Products and Freezer Wrap

Waxed paper, paper plates, cups and napkins should not be used for heating or cooking food. Freezer wrap should not be used as it is not heat resistant and may melt. Paper towel, greaseproof paper and bake paper may be safely used for short periods of time for covering or lining.

Glass, Ceramic and China

Heat-Resistant glass cookware is invaluable in microwave cooking. Many of these items are readily available in most homes: glass jugs, mixing bowls, loaf dishes, covered casseroles, oblong baking dishes, pie plates and round or square cake dishes. Examples of this type of cookware are Pyrex® and Corningware®.

Dinnerware can be used for microwave heating. Many brands of dinnerware are microwave safe. Check the care information for reference to microwave use for dinnerware and serving pieces. If dinnerware is marked ovenproof, it frequently is safe to use in the microwave oven. However, to be sure, check by conducting microwave dish test previously mentioned.

Several types of glassware and dinnerware are not recommended for use in the microwave oven. Do not use dishes with metallic trim or containers with metal parts. Do not use cups or mugs with glued on handles, as they may fall off with continued heating. Do not use delicate glassware. Although the glassware may be transparent to microwave energy the heat from the food may cause the glassware to crack.

Cookware and Utensils Guide (continued)

Plastics

Plastic dishes, cups and some freezer containers should be used with care in a microwave oven.

Choose plastic containers carefully, as some plastic containers may become soft, melt and may scorch. The majority of plastic dishes, even those designed for use in the microwave oven, are not suitable for cooking foods with high fat or sugar content, or for lengthy cooking times. Most microwave plastic dishes should not be used for longer than 3 to 5 minutes on **1000 W**. These dishes, although not suitable for extended cooking, may be used successfully for defrosting or for use on lower power levels.

Cooking Bags designed to withstand boiling, freezing, or conventional heating are microwave safe. Prepare bags according to manufacturer's directions. When cooking by microwave, **DO NOT** use wire twist-ties to close bag. They can act as an antenna and cause arcing (sparks).

DO NOT COOK IN PLASTIC FOOD STORAGE BAGS.

Plastic Wrap such as GLAD WRAP® can be used to cover dishes in most recipes. Over an extended heating time, some disfiguration of the wrap may occur. When removing plastic wrap "covers", as well as any glass lid, be careful to remove it away from you to avoid steam burns.

Loosen plastic but let dish stand, covered.

Jars and Bottles

Jars and bottles can be used to warm food to serving temperature, if the lid is removed first. Cooking should not be done in these containers since most are not heat resistant and during extended heating times, heat from food would cause cracking or breaking.

Metal

Metal cookware or utensils, or those with metallic trim, should **NOT** be used in the microwave. Since microwave energy is reflected by metal, foods in metal containers will not cook evenly. There is also a possibility of "arcing".

Although metal utensils should be avoided in microwave cooking, some metal can be helpful when used correctly.

Aluminum foil can be used safely, if certain guidelines are followed, to prevent overcooking. Small pieces of foil are used to shield areas such as chicken wings, tips of roasts, or other thin parts that cook before the rest of the recipe is finished. Make sure foil is attached securely and doesn't touch sides of oven, otherwise arcing may occur. Foil lined containers, either cardboard or plastic, should **NOT** be used in the microwave oven as arcing could occur.

Metal twist-ties, either paper or plastic coated, should **NOT** be used in the microwave oven. Frozen dinner trays can be used in the microwave, if the container is no deeper than 2 cm and is filled with food. Metal skewers can not be used in microwave ovens as arcing may occur. Wooden skewers are readily available and give the same result.

Shells: Scalloped baking shells are best used during reheating and for short periods of cooking time only.

Thermometers are available for use in microwave ovens. **DO NOT USE CONVENTIONAL MERCURY TYPE CANDY OR MEAT THERMOMETERS** in food while cooking in the microwave oven.

Straw, Wicker and Wood

Straw and wicker baskets may be used in the microwave oven for short periods of time to warm rolls or bread. Large wooden utensils, such as bowls or cutting boards should **NOT** be used for prolonged heating as the microwave energy may cause the wood to become dry and brittle.

Feature Diagram

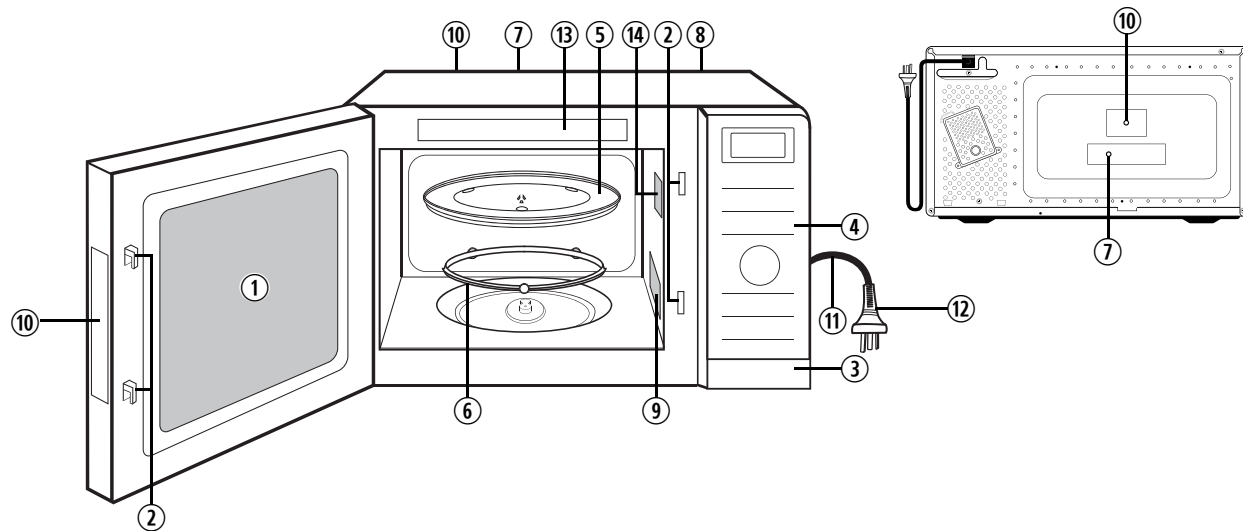

① **Oven Window**

② **Door Safety Lock System**

③ **Door Release Button**

Push to open the door. Opening the door during cooking will stop the cooking process without cancelling the program. Cook resumes as soon as the door is closed and **Start** Button is pressed. It is quite safe to open the door at any time during a cooking program and there is no risk of Microwave exposure.

④ **Control Panel**

⑤ **Glass Tray**

- DO NOT** operate the oven without the Roller Ring and Glass Tray in place.
- Only use the Glass Tray specifically designed for this oven. Do not substitute any other Glass Tray.
- If the Glass Tray is hot, allow to cool before cleaning or placing in water.
- DO NOT** cook directly on the Glass Tray. Always place food on a microwave-safe dish, or on a rack set in a microwave-safe dish.
- If food or utensil on the Glass Tray touches oven walls, causing the tray to stop moving, the tray will automatically rotate in the opposite direction. This is normal.
- Glass Tray can rotate in either direction.

⑥ **Roller Ring**

- Roller Ring should be cleaned regularly to avoid excessive noise.
- Roller Ring and Glass Tray should be used at the same time.

⑦ **Identification Plate**

⑧ **Oven Air Vent**

⑨ **Waveguide Cover** (do not remove)

⑩ **Warning Label**

⑪ **Power Supply Cord**

⑫ **Power Supply Plug**

⑬ **Menu Label**

⑭ **Oven Light**

Oven light will turn on during cooking and also when door is opened.



Note

- The above illustration is for reference only.
- The glass tray is the only accessory with this oven. All other cooking utensils mentioned in this manual must be purchased separately.

Control Panel

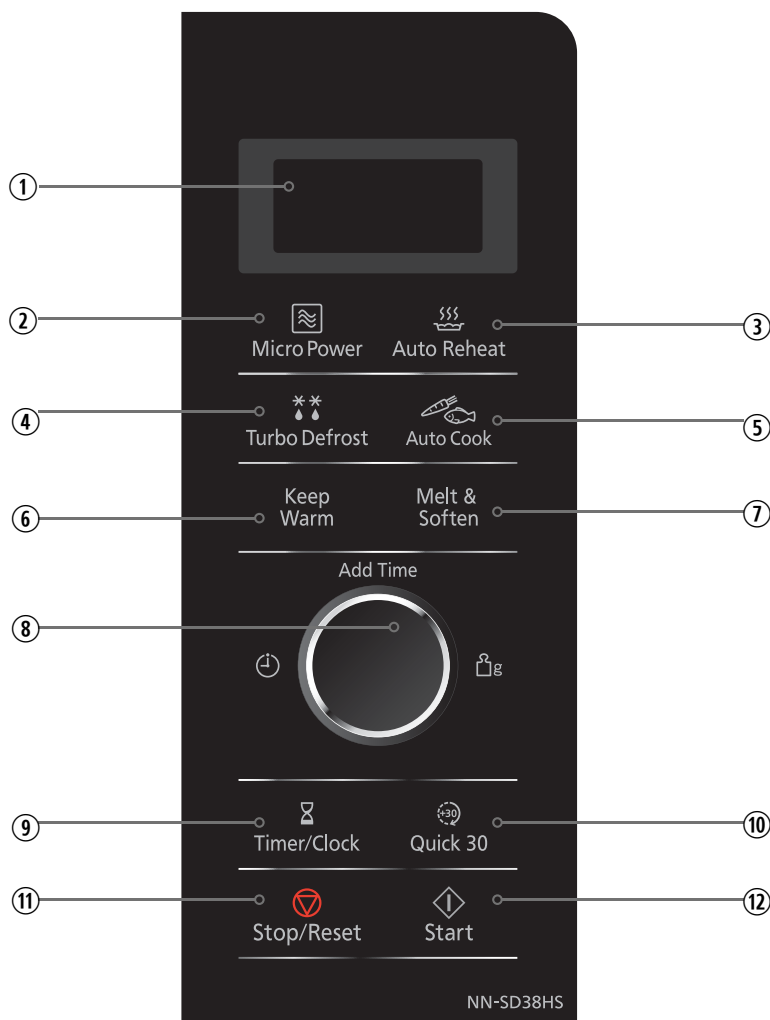

CONTROL PANEL

- 1. Display Window**
- 2. Mico Power Button (Pg.13, 15,16)**
- 3. Auto Reheat Button (Pg.22)**
- 4. Turbo Defrost Button (Pg.16)**
- 5. Auto Cook Button (Pg.22)**
- 6. Keep Warm Button (Pg.25)**
- 7. Melt & Soften Button (Pg.25)**
- 8. Dial (Pg.14)**
Enter time or weight of food by turning the dial.
Use the dial for the Add Time feature. (page 18)
- 9. Timer/Clock Button (Pg.14, 27)**
- 10. Quick 30 Button (Pg.21)**
- 11. Stop/Reset Button**
Before cooking: One tap clears all your instructions.
During cooking: One tap temporarily stops the cooking process. Another tap cancels all your instructions and colon or time of day appears in the Display Window.
- 12. Start Button**
One tap allows oven to begin functioning. If door is opened or **Stop/Reset** Button is pressed once during oven operation, **Start** Button must again be pressed to restart oven.



Note

If an operation is set and **Start** Button is not pressed, after 6 minutes, the oven will automatically cancel the operation. The display will revert back to clock or colon mode.



Beep Sound

When a button is pressed correctly, a beep sound will be heard. If a button is pressed and no beep is heard, the unit does not or cannot accept the instruction. The oven will beep twice between programmed stages. At the end of any complete programme, the oven will beep five times.

Let's Start To Use Your Oven!

1 Plug in.

After plugging in, "88:88" will appear in the display window, then you can start to operate.

2 Open Door.

Open the door and place container with food in a dish on Glass Tray in the oven. Then close the door.

3 Select Power Level.

eg. 800W (MEDIUM-HIGH)
Press **Micro Power Button** twice.
(see page 15 for Micro Power chart)



4 Set Time.

e.g. 1 minute 30 seconds
Rotate the Time Dial

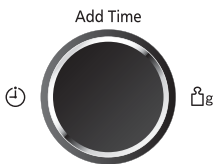

5 Press Start.

Verify your selection(s) in the Display Window.

To Use Child Safety Lock

This feature allows you to prevent operation of the oven by a young child; however, the door will open.
This feature can be set when colon or time of day is displayed.

To set:



Press Start three times.
Colon or time of day will disappear.
Actual time will not be lost.

"" appears in the display window.

To cancel:



Press Stop/Reset three times.
Colon or time of day will reappear in the display window.

To set or cancel child safety lock, **Start** Button or **Stop/Reset** Button must be pressed 3 times within 10 seconds.

To Set Clock

You can use the oven without setting the clock.

1 Press  **twice.**

Colon will blink in the display window.

2 Enter Time of Day.

Enter time of day using the dial. Time appears in the display window; colon is blinking.

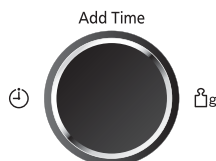

Note:

Turning the dial slowly will count up in 1 minute steps. Turning the dial quickly will count up in 10 minute steps.

3 Press 

Colon stops blinking; time of day is entered and locked in the display window.



Note

1. To reset time of day, repeat steps 1-3.
2. The clock will keep the time of day as long as oven is plugged in and electricity is supplied.
3. Clock is a 12-hour display.
4. Oven will not operate while colon is blinking.

Dial Features

Press and release dial to expand (pop-out). After setting desired program, push dial in to avoid accidental changing of the Programmed time.

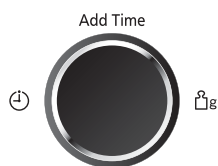

TIME CHOICE

Push then rotate the dial. Rotate the dial clockwise to increase the cooking time and rotate the dial counter-clockwise to decrease the cooking time.

Note:

This dial can be used during manual cooking. This feature allows you to increase or decrease cooking time in 1 minute (up to 10 minutes). Turning the dial to zero will end cooking.

WEIGHT CHOICE

Push then rotate the dial. Rotate the dial clockwise to increase the weight and rotate the dial counter-clockwise to decrease the weight setting.

NOTE:

The maximum programmable time using Time Dial is up to 90 minutes.

To Cook/Reheat/Defrost on Micro Power by Time Setting

1 Press to Select Micro Power Level.

Press **Micro Power** button until your desired power level appears in the Display Window. (see chart below)

Press	Power Level	Example Of Use
once	1000 W (HIGH)	Boil water. Reheat. Cook vegetables, rice, pasta and noodles.
twice	800 W (MED-HIGH)	Cook poultry, meat, cakes, desserts. Heat milk.
3 times	600 W (MEDIUM)	Cook beef, lamb, eggs, fish and seafood. Melt butter.
4 times	440 W (MED-LOW)	Simmer soups, stews and casseroles (less tender cuts).
5 times	300 W (DEFROST)	Thaw foods.
6 times	100 W (LOW)	Keep cooked foods warm, simmer slowly.

2 Set Cooking Time

Select cooking time by turning the dial.

(1000 W : up to 30 minutes, Other Powers : up to 1 hour and 30 minutes)

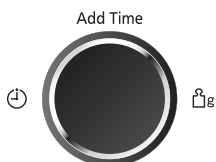

3 Press .

Cooking will start.

The time in the display window will count down.



Note

1. It is possible to programme no more than 3 stages cooking as one cooking set. For 2 or 3 stages cooking, repeat steps 1 and 2 above before pressing **Start** button. When operating, two beeps will be heard between each stage. (Please refer to page 23 for details).
2. You can change the cooking time during cooking if required. Turn dial to increase or decrease the cooking time. Time can be increased/decreased in 1 minute increments, up to 10 minutes. Turning the dial to zero will end cooking.
3. Do not use metal containers on microwave mode.
4. Stand time can be programmed after Micro Power and time setting.
Refer to using the timer page 24.
5. When cooking time is longer than 60 minutes, the time will appear in hours and minutes.
6. After using the oven, the fan may rotate to cool the electric components and "COOL" appears in the display window. This is perfectly normal, and you can take out the food from the oven while the fan operates.

To Defrost on Micro Power by Time Setting

If you want to decide the defrost time by yourself, please select this button and operate the following.

1 Press  **5 times for 300W.**

2 Set Cooking Time.

Set defrosting time by turning the dial. (up to 1 hour and 30 minutes)

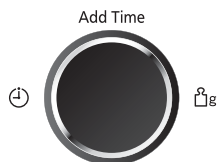

3 Press  **.**

Press Start . Defrosting time appears in the display window and begins to count down.



Note

1. Opening the door and taking out the defrosted parts during the operating time is recommended. turn over, stir or rearrange the parts which are still in icy.
2. For manual defrosting times, please refer to defrost chart on page 25.

To Defrost Using Turbo Defrost

This feature allows you to defrost meat, poultry and seafood automatically by just setting the weight. The serving/weight is 0.1 kg to 2.0 kg.

1 Press  **.**

2 Set Weight.

Select the Weight of food by turning the dial.

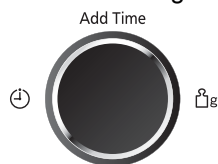

3 Press  **.**

Press Start. Defrosting time appears in the display window and begins to count down.

To Defrost Using Turbo Defrost (continued)

Food	Maximum Weight
Minced meat, Chicken Pieces, Chops	2 kg
Beef roast, lamb, whole chickens	2 kg
Whole fish, scallops, prawns, fish fillets	1 kg

Tips for Turbo defrost

Meat, which is with bones. For example, if the meat with bones has the same weight as the pure meat, the meat in the former one is lighter than the latter one. So, subtract 0.5 kg for 2 kg meat with bones is better for defrosting and 0.25 kg for meat with bones which is less than 2 kg.

Two buzz beeps

Turn over the meat, chicken, fish and shellfish. Separate the stewed meat, chicken pieces and meat loaf. Apart the meat loaf from the hamburger. Shield the edge of chicken wings, roast, fat or bones.

Key to defrosting

For evenly defrosting, turn over the foods or move the position of the foods in the containers during the progress of defrosting.

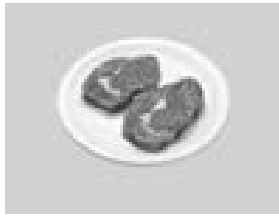

Remove the package of the raw meat and place it on the plate.



Shield the front part of the chicken drumsticks by using aluminum foil.

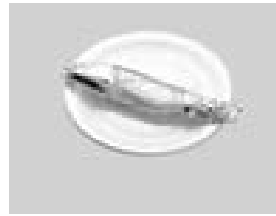

Shield the head and tail of the whole fish by using aluminum foil.

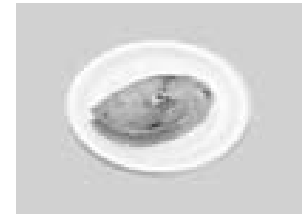

Remove the package of the fish fillet and place it on the plate.

To Cook Using the Quick 30 Feature

This feature allows you to quickly set cooking time in 30 second increments.



1. Press **Quick 30** to set the desired cooking time (up to 5 minutes). Each press is 30 seconds. Time appears in the display. Power level is pre-set at 1000 W.

2. Press **Start**. The cooking will start and the time in the display will count down. At the end of cooking, five beeps will sound.



Note

1. This feature is only available for Micro Power mode. Select desired micro power level before pressing **Quick 30**.
2. After setting the time by **Quick 30**, you cannot use dial.
3. This feature will not operate for 1 minute after manual cooking.

Using the Add Time Feature

This feature allows you to add cooking time at the end of previous cooking.

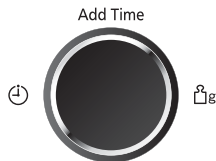

1. After cooking, turn dial to select Add Time feature. Maximum cooking time: Microwave: 1000 W up to 30 minutes; other powers up to 1 hour and 30 minutes;

2. Press **Start**. Time will be added. The time in the display window will count down.



Note

1. This feature is not available for Turbo Defrost and Auto Menu (Auto Reheat, Auto cook and Melt Soften).
2. The Add Time feature will not operate after 1 minute cooking.
3. The Add Time feature can be used after the 3-stage cooking.
4. The power level is the same as the last stage. This feature will not operate if the last stage was standing time.

To Cook/Reheat Food Using Auto Menus

This feature allows you to cook foods without selecting times and Power Level. Only set desired menu number and Serving/Weight, the oven will cook your food automatically.

1 Select Desired Menu Number.

Press to select the desired button until the desired menu number appears in the display window.

2 Select Desired Serving/Weight.

Select the Weight of food by turning the dial. (see chart below)

3 Press



The cooking time appears in the display window and begins to count down.

Press



Menu No.	Category	Weight				Recommended containers
		200 g	400 g	600 g	800 g	
1	Reheat Meal	200 g	400 g	600 g	800 g	microwave safe bowl with plastic wrap
2	Reheat Bread	50 g	100 g	150 g	200 g	microwave safe dish
3	Reheat Soup	1 cup	2 cups	3 cups	4 cups	microwave safe cup

Press



Menu No.	Category	Weight				Recommended containers
		120 g	180 g	250 g	370 g	
4	Vegetables	120 g	180 g	250 g	370 g	casserole with lid
5	Frozen Vegetables	150 g	300 g	450 g	600 g	casserole with lid
6	Potatoes	200 g	400 g	600 g	—	casserole with lid
7	Fresh Paste	150 g	250 g	375 g	—	casserole
8	Dried Pasta	150 g	250 g	375 g	—	casserole
9	Casserole Rice	100 g	200 g	300 g	—	casserole with lid
10	Fish	100 g	200 g	300 g	400 g	microwave safe dish with plastic wrap
11	Chicken	200 g	400 g	600 g	800 g	casserole with lid
12	Curries	200 g	400 g	—	—	casserole with lid



Note

1. When you select an Auto Cook program, the auto and cooking feature indicators light and menu number appear in the display.
2. Only cook foods within the weight ranges described.
3. Always weigh the food rather than relying on the package information.
4. Most foods benefit from a standing time, after cooking with an Auto Cook Program, to allow heat to continue conducting to the centre.

To Cook/Reheat Food Using Auto Menus (continued)

For best results on Auto Cook, follow these recommendations:

1. Reheat Meal

Suitable for casseroles, plated dinners, soups, stews, pasta dishes (except lasagne), and canned food. All foods must be pre-cooked and reheated from room temperature or refrigerator temperature. Do not reheat bread or pastry products; raw; uncooked or frozen foods; or beverages on this setting. Foods weighting less than 200 g and more than 800 g should be reheated by Micro Power and Time only.

Foods should be placed in a suitable size microwave safe bowl and completely covered with plastic wrap. Add 1-4 tbsp of water for desired. Stir at beep sounds. At the end of the cooking time, stir and let stand for 3 to 5 minutes.

2. Reheat Bread

It is suitable for reheating bun at refrigerator temperature (5-7 °C). Put the bun on a suitable size microwave safe dish. Cook without cover.

Note: 50 g = one standard slice of bun.

3. Reheat Soup

It is suitable for reheating soup at refrigerator temperature (5-7 °C). Put soup into microwave safe cup. Cook without cover. Stir before serving.

Note: 1 cup = 180 ml

4. Vegetables

Suitable for cooking a variety of fresh vegetables. All vegetables should be trimmed or prepared and cut into even size pieces. Place prepared vegetables into a suitable size microwave-safe casserole and add 2-4 tbsp of water for desired. Cover with a well fitting lid. When cooking larger quantities of vegetables, the oven will 'beep' to prompt you to stir the foods. At the end of the cooking time, let it covered and stand for 3 to 5 minutes.

5. Frozen Vegetables

Suitable for all types of frozen vegetables, like frozen peas, sweetcorn or mixed vegetables. Place prepared vegetables into a suitable size microwave-safe casserole and add 2-6 tbsp of water for desired. Cover with a well fitting lid. Stir after the beep sounds. At the end of cooking, let it covered and stand for 3 to 5 minutes.

6. Potatoes

Suitable for cooking potatoes. Pare potatoes well and cut into even size pieces. Place in a suitable size microwave safe casserole and add 2-4 tbsp of water for desired. Cover with a well fitting lid. Stir after beep sounds.

7. Fresh Pasta

Suitable for cooking a variety of fresh pastas. Place them into a suitable sized microwave safe casserole with boiling water. Allow at least ½ depth of volume for evaporation to prevent boiling over. Use the following as a guide:

Fresh Pasta	Recommended Boiling Water	Dish Size
150 g	3 cups	3 litre
250 g	4 cups	3.5 litre
375 g	5 cups	3.5 litre

(It may be necessary to adjust the amount of water to your personal preference.)

Do not cover with lid. **Do not** cook in plastic containers unless suitable for high temperature cooking. Stir after beep sounds. Allow pasta to stand for 5 to 10 minutes after cooking if required then drain.

8. Dried Pasta

Suitable for cooking a variety of dried pastas. Place them into a suitable sized microwave safe casserole with boiling water. Allow at least ½ depth of volume for evaporation to prevent boiling over. Add a little oil if desired. Use the following as a guide:

Dried Pasta	Recommended Boiling Water	Dish Size
150 g	4 cups	3 litre
250 g	5 cups	3.5 litre
375 g	6 cups	3.5 litre

(It may be necessary to adjust the amount of water to your personal preference.)

Only cover with lid at **stage 1**. **Do not** cook in plastic containers unless suitable for high temperature cooking. Stir after beep sounds. Allow pasta to stand for 5 to 10 minutes after cooking if required then drain.

To Cook/Reheat Food Using Auto Menus (continued)

9. Casserole Rice

Suitable for cooking white rice including short grain, long grain, Jasmine and Basmati. Place washed rice with recommended amount of cold water in a suitable sized casserole. Allow at least $\frac{1}{3}$ depth of volume for evaporation to prevent boiling over. Use the following as a guide:

Rice	Recommended Water	Dish Size
100 g	150 ml	2.5 litre
200 g	300 ml	3 litre
300 g	450 ml	3.5 litre

(It may be necessary to adjust the amount of water to your personal preference.)

Cover with a well fitting lid. **Do not** cook in plastic containers unless suitable for high temperature cooking. Stand rice for 5 to 10 minutes after cooking, if necessary. This setting is **not** suitable for cooking brown rice.

10. Fish

Suitable for cooking whole fish and fish fillets. Select fish suitable for microwave cooking and place in a single layer in a shallow microwave safe dish, with skin-side down. Add butter, spices, herbs, or lemon juice to flavor. Overlap thin edges of fillets to prevent overcooking. If stuffing whole fish with seasoning, cooking time may need to be extended. Use the following as a guide:

Fish	Recommended sauce and little water
100 g	1 tbsp sauce and little water
200 g	2 tbsp sauce and little water
300 g	3 tbsp sauce and little water
400 g	4 tbsp sauce and little water

(It may be necessary to adjust the amount of water or sauce to your personal preference.)

Shield the eye and tail area of whole fish with small amounts of aluminum foil to prevent overcooking. Cover dish securely with plastic wrap. Allow large amounts of fish to stand for 3 to 5 minutes after cooking before serving.

Note: (thickness of fish should **not** be more than 3 cm)

11. Chicken

It is suitable for cooking chicken pieces such as wings, drumsticks, thighs, half breasts etc. Chicken pieces should be thawed completely. Pierce the chicken pieces well with fork before cooking. Place prepared chicken pieces in a suitable size microwave safe casserole. Cover with well fitting lid. Stir after beep sounds.

Chicken Pieces	Recommended Oil
200 g	3 tsp. oil
400 g	4 tsp. oil
600 g	5 tsp. oil
800 g	6 tsp. oil

12. Curries

The weight we suggested is only for meat. See chart below for quantities to use.

Weight of meat	Coconut milk and stock	Weight of hards vegetables
200 g	100 ml	80 g
400 g	200 ml	160 g

Cut meat and vegetables into even size pieces. Place all ingredients into a suitable size microwave safe casserole. Cover with well fitting lid. Stir after beep sounds.

Melt & Soften Feature

This feature allows you to melt/soften food at the touch of a button. There is no need to select the power level or cooking time as the microwave does this for you.

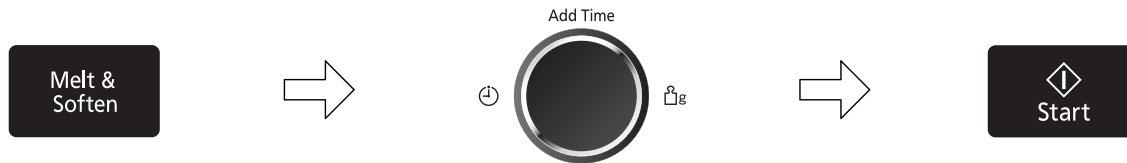

1. Press **Melt & Soften** button until the desired menu number appear in the display window. (see chart below)
2. Select the Weight of food by turning the dial. (see chart below)
3. Press **Start**. The time in the display window will count down.

Menu No.	Category	Weight						Recommended containers
13	Melt Butter	50 g	100 g	150 g	200 g	250 g	300 g	microwave safe dish with plastic wrap
14	Soften Cream Cheese	50 g	100 g	150 g	200 g	250 g	300 g	microwave safe bowl or dish
15	Soften Ice Cream	300 g	600 g	900 g	1200 g	—	—	—
16	Melt Chocolate	50 g	100 g	150 g	200 g	250 g	300 g	microwave safe dish

For best results, follow these recommendations:

13. Melt Butter

Remove wrapper, cut butter into 2 tbsp cube, and place into a microwave safe dish. Melt with lid or plastic wrap. Stir after cooking.

14. Soften Cream Cheese

Remove wrapper and place in a microwave safe bowl/ dish. Soften without cover.

15. Soften Ice Cream

Soften slightly without lid.

16. Melt Chocolate

Remove wrapper and place chocolate into a microwave safe dish. Cook without cover. After heating, stir until completely melted.

Note: Chocolate holds its shape even when softened.



Note

If food needs more time cooking or weight exceeds range, cook using 300 W for melting and softening.

Keep Warm Feature

This feature will keep food warm for up to 30 minutes after cooking.

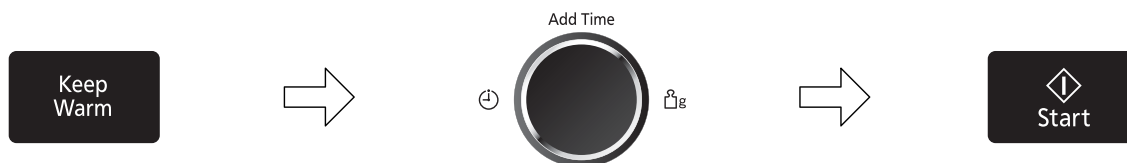

1. Press **Keep Warm** button once.
2. Set warming time by turning the dial.
3. Press **Start**. Keep Warm will start. The time in the display window will count down.



Note

Keep Warm can be programmed as the final stage after cook times have been manually entered. It cannot be programmed together with Turbo Defrost and Auto Menus (Auto Reheat, Auto Cook and Melt & Soften).

3-Stages Setting

This feature allows you to program 3 Stages of cooking continuously.

E.g.: Continually set [1000 W] 2 minutes, [600 W] 3 minutes and [100 W] 2 minutes.

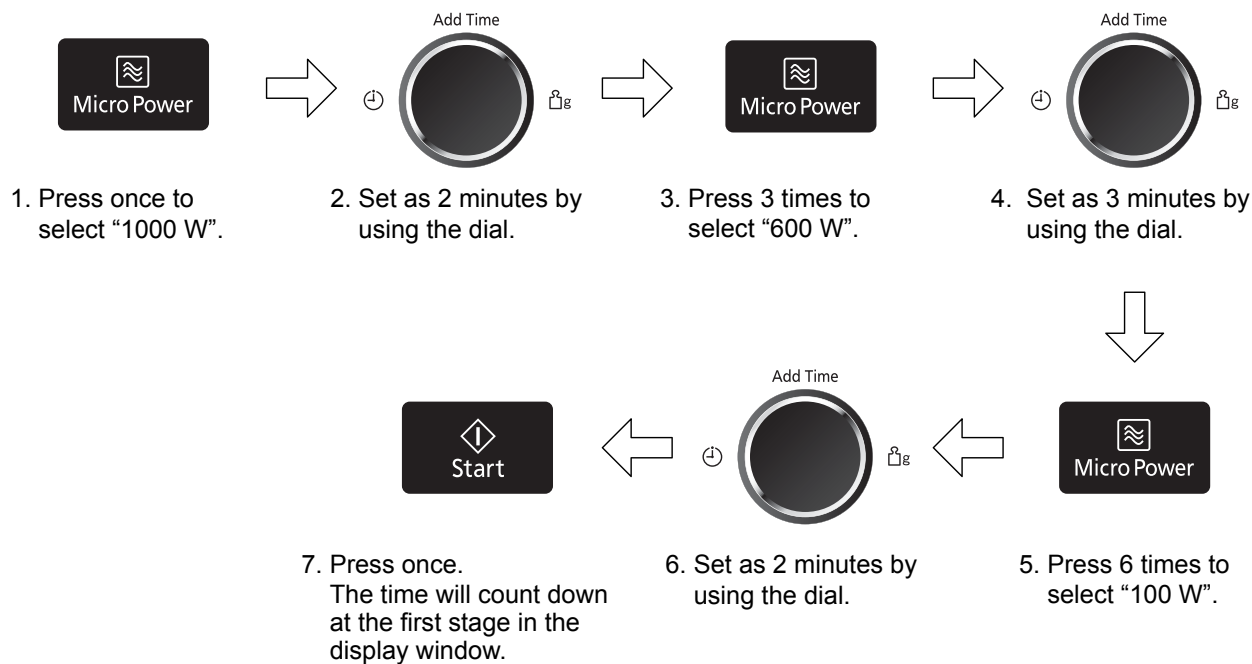

Note

1. When operating, two beeps will sound between each stage.
2. This feature is not available for Turbo Defrost and Auto Menus (Auto Reheat, Auto cook and Melt & Soften).

INGREDIENT CONVERSION CHART

INGREDIENT CONVERSION CHART			
¼ cup	60 ml	¼ teaspoon	1 ml
⅓ cup	85 ml	½ teaspoon	2 ml
½ cup	125 ml	1 teaspoon	5 ml
⅔ cup	165 ml	2 teaspoons	10 ml
¾ cup	190 ml	3 teaspoons	15 ml
1 cup	250 ml	1 tablespoon	20 ml
1¼ cups	310 ml	1½ tbs	30 ml
1½ cups	375 ml	2 tbs	40 ml
2 cups	500 ml	3 tbs	60 ml
3 cup	750 ml	4 tablespoons	80 ml
3½ cups	875 ml		
4 cups	1 litre		
6 cups	1.5 litre		
8 cups	2 litre		

All recipes are tested using standard measurement that appear in the above chart.

To Use Timer

This feature allows you to use the oven as a kitchen timer. It can be also a stand time after cooking is completed or to program a delay start.

To Use as a Kitchen Timer.

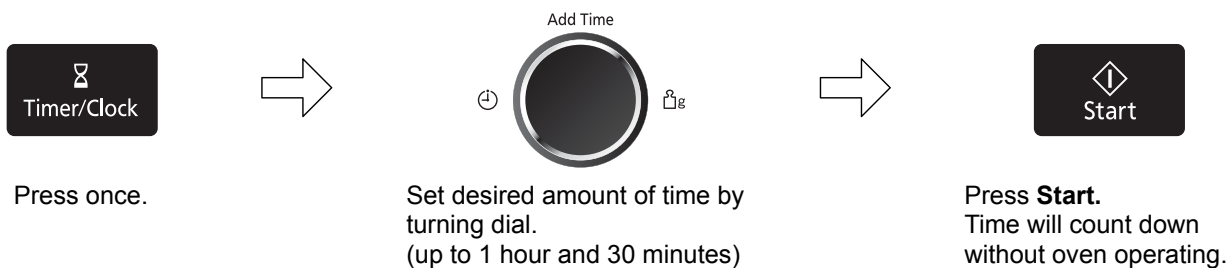

To Set Standing Time.

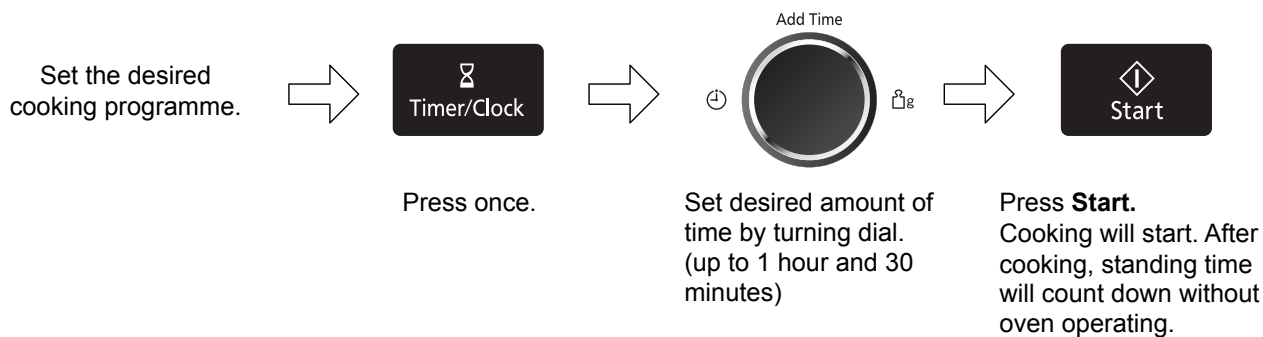

To Set Delay Start.

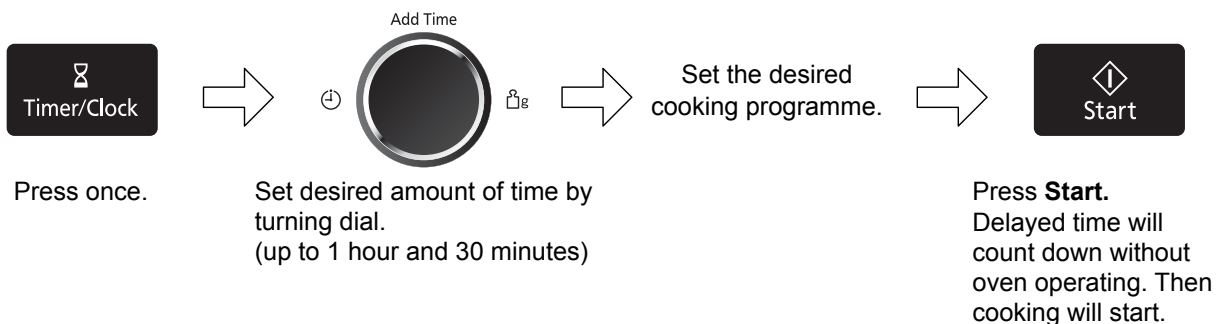

Note

1. If oven door is opened during the Standing Time, Delay Start or Kitchen Timer, the time in the Display Window will continue to count down.
2. Delay Start and Standing Time cannot be programmed together with Turbo Defrost and Auto Menus (Auto Reheat, Auto Cook and Melt & Soften). This is to prevent the standing temperature of the food from rising before defrosting or cooking begins. A change in the starting temperature could cause inaccurate results.
3. When using Standing time or Delay time, it's up to 2 Power stages.

Defrosting Chart

The times given below are a guideline only. Always check the progress of the food by opening the oven door and then re-starting. For larger quantities adjust times accordingly. Food should not be covered during defrosting.

Food	Weight/Quantity	Time & Mode	Method
Beef/Lamb/Joint (1)(3)	450 g (1 lb)	300 W 6-8 mins	standing 30 mins
Steaks (1)(3)	2 pcs 250 g	300 W 3-4 mins	standing 3 mins
Minced beef (1)(3)	450 g (1 lb)	300 W 6-7 mins	standing 5 mins
Stewing steak (1)(3)	450 g (1 lb)	300 W 6-8 mins	standing 10 mins
Whole chicken (1)(3)	450 g (1 lb)	300 W 5-7 mins	standing 10 mins
Chicken portions (1)(3)	450 g (1 lb)	300 W 6-8 mins	standing 5 mins
Whole fish (1)(3)	450 g (1 lb)	300 W 6-8 mins	standing 5 mins
Fish fillets (2)(3)	450 g (1 lb)	300 W 5-7 mins	standing 5 mins
Prawns (2)(3)	450 g (1 lb)	300 W 4-6 mins	standing 5 mins
Fruits, soft (1)	250 g	300 W 2-3 mins	standing 2 mins
Margarine (3)	250 g	300 W 1-2 mins	standing 2 mins
Cheese (3)	450 g (1 lb)	300 W 2-4 mins	standing 2 mins
Plated meals homemade adult size (2)	350 g	300 W 5-6 mins	standing 3-5 mins
Cooked Fruit (2)	540 g	300 W 4-5 mins	standing 3-5 mins
Cooked meat (2)	520 g	300 W 6-8 mins	standing 3-5 mins
Quiche (3)	1 pc 65 g	300 W 1-2 mins	standing 2 mins
Casseroles (1)	750 g	1000 W 6-7 mins	standing 3-5 mins
Bread rolls (1)	1 pc 85 g	1000 W 20-30 secs	standing 5 mins
Pastry puff (1) (3)	1 roll 375 g	300 W 2 mins-2 mins 30 secs	Stand time 20 mins in refrigerator
Pastry shortcrust (1) (3)	1 roll 500 g	300 W 4-5 mins	Stand time 20 mins in refrigerator
Pizza dough (1) (3)	1 ball 240 g	300 W 2 mins-2 mins 30 secs	standing 10 mins
Fruit tarte (3)	470 g	300 W 4-5 mins	standing 5 mins
Cheese cake (3)	600 g	300 W 2-3 mins	standing 5 mins
Fruit pie (3)	500 g	300 W 6-8 mins	standing 5 mins
Meat pie (3)	300 g	300 W 4-6 mins	standing 3 mins

- (1) Turn or stir at half time.
- (2) Separate and turn several times.
- (3) Remove packaging and place on a heat resistant plate.

Reheating Chart

The times given in the charts below are a guideline only, and will vary depending on starting temperature, dish size etc.

Food	Weight/ Quantity	Time & Mode	Method
Drinks-Coffee-Milk			
Coffee	1 mug 235 ml	1000 W 1 min 30 secs	Stir before, and after reheating.
Coffee	2 mugs 470 ml	1000 W 2 mins 30 secs- 3 mins	
Milk	1 mug 235 ml	1000 W 1 min 20 secs- 1 min 30 secs	
Breads			
Croissants	1 pc 50 g	1000 W 10-20 secs	Place on microwave safe plate on glass tray. Do not cover. Turn at half time.
	2 pcs 100 g	1000 W 30-40 secs	
Rolls	1 pc	1000 W 10-20 secs	
	4 pcs	1000 W 30-40 secs	
Naan bread	225 g	1000 W 30-40 secs	
Pitta bread	2 pcs	1000 W 20-30 secs	
Plated meals-Homemade			
Vegetables (cooked)	300 g	1000 W 2 mins	Cover. Stir at half time.
	700 g	1000 W 5 mins-5 mins 30 secs	
Potato puree	500 g	1000 W 3-4 mins	
Rice, quinoa, couscous	300 g	1000 W 2 mins-2 mins 20 secs	
Babyfood	120 g	600 W 30-40 secs	
Canned Food			
Baked beans	225 g	1000 W 1 min 30 secs-2 mins	Place in a microwave safe bowl on glass tray. Cover. Stir halfway.
Spaghetti in tomato sauce	200 g	1000 W 1 min 30 secs	
Cream of tomato soup	400 g	1000 W 2 mins 30 secs	
Chicken soup	425 g	1000 W 3 mins 30 secs	
Pastry Products			
Quiche	400 g	1000 W 2-3 mins	Place on microwave safe plate on glass tray. Do not cover.
Samosas/spring rolls	4 pcs 240 g	1000 W 1-1 min 30 secs	
Purchased Convenience Foods			
Cottage pie (chilled)	450 g	1000 W 5-6 mins	Place on microwave safe plate on glass tray. Do not cover.
Lasagne (chilled)	400 g	1000 W 7-8 mins	
Sausage rolls	250 g	600 W 3-5 mins	

Cooking Chart

Food	Weight/Quantity	Time & Mode	Method
Beans & Pulses-should be pre-soaked (except lentils)			
Chick peas	225 g	1000 W 8 mins then 440 W 15-20 mins	Use 600 ml (1 pt) boiling water in a large bowl. Cover. Stir halfway.
Lentils	225 g	440 W 35-40 mins	
Red kidney beans	225 g	1000 W 15 mins then 440 W 35-40 mins	
Fruit-Peel, slice, chop into even sized pieces. Place in shallow microwave safe dish.			
Apples, Rhubarb, stewed	450 g	1000 W 7-8 mins	Add 30 ml (2 tbsp.) of water. Only half fill dish. Cover. Stir halfway.
Plums-stewed	450 g	1000 W 8-10 mins	
Lamb/Beef-from raw-Caution: Hot Fat! Remove dish with care.			
Chops	450 g (1 lb)	800 W 4-5 mins then 600 W 3-4 mins	Place on heatproof plate. Turn halfway.
Cultets	450 g (1 lb)	600 W 10-12 mins	
Pasta-Place in a large 3 litre (6 pints) microwave safe bowl			
Macaroni	225 g	1000 W 13-15 mins	Use 1 litre (1¾ pints) boiling water. Cover. Stir halfway.
Spaghetti, Tagliatellie	225 g	1000 W 11-12 mins	
Pizza-Fresh chilled- N.B. Remove all packaging. Pizza will have a soft base.			
Thin & Crispy	300 g	1000 W 2-3 mins	Place on heatproof plate on glass tray. Do not cover.
Deep pan	400 g	1000 W 4-6 mins	
Fish & Shellfish			
Whole fish	350 g	600 W 7-8 mins	Place on heatproof dish. Turn or stir halfway.
Sea scallops	450 g	600 W 8-10 mins	
Green prawns	250 g	600 W 4-5 mins	
Sausages-from raw-Caution: Hot Fat! Remove dish with care.			
Thick	4 pcs 240 g	1000 W 2-3 mins	Place on microwave safe plate on glass tray. Cover. Turn halfway.
Thin	4 pcs 120 g	1000 W 1 min 30 secs- 2 mins 30 secs	



Note

Always check that food is piping hot after reheating in the microwave. If unsure, return to oven. Foods will still require a stand time, especially if they cannot be stirred. The denser the food the longer the stand time.

Microwave Recipe Techniques

Microwaves penetrate the surface of the food to a depth of about two to three centimetres and then the heat is gradually conducted in a random pattern. Some parts of food matter cook faster than others. Special microwave techniques are used to promote

fast and even cooking. Some of these techniques are similar to those used in conventional cooking, but because microwaves produce heat very quickly the following techniques are extremely important. It's a must for you to be familiar with the following tips.

Food Characteristics

Size and Quantity

Small portions cook faster than large portions. As you increase the quantity of food you put into the microwave oven, you must also increase your cooking time. The microwave oven has the same power regardless of quantity; thus the power is divided between more items and so it takes longer to cook. As a general guide, if you double the quantity of food suggested in the recipe, add half the time suggested again.

Liquid Content

Low moisture foods take a shorter time to cook than foods with a lot of moisture.

Shape

Uniform sizes cook more evenly. To compensate for irregular shapes, place thin pieces towards the centre of the dish and thicker pieces towards the outer edge of the dish.

Bone and Fat

Bones conduct heat and cause the meat next to them to be heated more quickly. Large amounts of fat absorb microwave energy and the meat next to these areas may overcook.

Starting Temperature

Food which has been sitting at room temperature takes less time to cook than refrigerated or frozen food.

Density and Composition

Porous, airy foods (cakes and breads) take less time to cook than heavy compacted foods (meat and vegetables). Recipes high in fat and sugar content cook more quickly.

Techniques for Preparation

Timing

A range of cooking times is given in each recipe for two reasons. First, to allow for the uncontrollable differences in food shapes, starting temperatures and personal preferences. Secondly, these allow for the differences in electrical voltage input which changes during peak load periods. Always remember that it is easier to add time to undercooked food. Once the food is overcooked, nothing can be done. For each recipe, an approximate cooking time is given.

Stirring

Stirring is often necessary during microwave cooking. We have noted when stirring is helpful in the recipes. Always bring the outside edges towards the centre and the centre portions to the outside.

Rearranging or Turning

Some foods should be turned in the container during cooking. For example, because of the different thicknesses in the breast and back sections of poultry, it is a good idea to turn poultry over once to ensure more even cooking.

Rearranging or turning over uneven shaped food in the dish should be done as suggested to ensure a satisfactory result. Rearrange small items such as chicken pieces, prawns, hamburger patties, steak or chops. Rearrange pieces from the centre to the edge of the dish.

Cooking in Layers

Cooking in layers is not always successful as it takes twice as long to cook a single layer and cooking may be uneven. You can successfully reheat two dinner plates of food at one time but remember to increase the reheating time and use a microwave warming rack.

Piercing of Foods

Pierce the skin or membrane of foods when cooked whole in the microwave oven. This allows steam to escape. If the skin has not been pierced, food may burst.

Cured Meats

Cured meats may overcook in some areas due to the high concentration of salts used in the curing process. So take care when cooking different brands of bacon as cooking times may vary slightly.

Microwave Recipe Techniques (continued)

Covering

Covering food minimizes the microwave cooking time. Because microwave cooking is done with time and not direct heat, the rate of evaporation cannot be easily controlled. However, this can be corrected by using different materials to cover dishes. Plastic wrap is the best substitute for a lid as it creates a tighter seal and so it retains more heat and steam. Wax paper and paper towels hold the heat in but not the steam. These materials also prevent splattering. Use a paper towel, wax paper or no cover when steam is not needed for tenderising.

Browning

Meats and poultry, when cooked longer than 10 to 15 minutes, will brown from their own fat. Foods cooked for shorter periods of time can be aided with the help of a browning sauce, worcestershire sauce or soy sauce. Simply brush one of these sauces over meat or poultry before cooking. Baked goods do not need long cooking time and therefore, do not brown. When cakes or cupcakes are iced, no one will notice the visual difference. For cakes or cupcakes, brown sugar can be used in the recipe in place of caster sugar or the surface can be sprinkled with dark spices before baking.

Standing Time

The moisture molecules continue to vibrate in the food when the microwave oven has turned itself off. After all, the molecules were vibrating at 2,450,000,000 times per second during cooking. So cooking continues even after the food is no longer being exposed to the microwaves whether in or outside your microwave oven.

Standing time refers to the time it takes (after the microwave time is completed) to allow the interior of the food to finish cooking.

The amount of standing time varies with the size and density of the food. In meat cookery, the internal temperature will rise between 5°C and 10°C if allowed to stand covered for ten to fifteen minutes. Rice and vegetables need shorter standing time, but this time is necessary to allow foods to complete cooking in the centre without overcooking on the edges.

The power level used in microwave cooking also determines the standing time. For example, when using a lower power level the standing time is shorter because of a lower concentration of heat in the food. Foods should always be kept covered while standing in order to retain the heat. If a longer standing time is required (while you cook another food to serve with the first, for instance), cover with aluminum foil.

Converting Your Favourite Conventional Recipes for Microwave Cooking

When adapting conventional recipes for microwave cooking, times are reduced considerably.

For example, a chicken which takes 1 hour to cook in a moderate oven will take 20 to 30 minutes on 600 W in your microwave oven.

Use similar microwave recipes to help you adapt conventional recipes. Remember, it is always best to undercook a recipe and then add an extra minute or two to finish it off.

Here are some other tips that may help:

- Reduce liquids in a conventional recipe by one half to two thirds, e.g. 1 cup (250 ml) should be reduced to ½ cup (125 ml).
- Add more thickening such as flour or cornflour to sauces and gravies if you do not reduce the liquid.
- Reduce seasonings slightly in a recipe where ingredients do not have time to simmer by microwave.
- Do not salt meats, poultry or vegetables before cooking; otherwise, they will toughen and dry out.
- If one ingredient takes longer to cook than the others, precook it in the microwave oven first. Onion, celery and potato are examples.
- When cooking meat or vegetables, omit any oil or fat that would have been used for browning in a conventional recipe.
- Reduce leavening agents for cakes by one quarter and increase liquids by one quarter.
- Biscuits require a stiff dough. Increase flour by about 20 percent. Substitute brown sugar for white sugar and use biscuit recipes that have dark spices or require icing. Because of the short cooking time, biscuits don't have to brown. Chill dough for half an hour before baking. This produces a crisper biscuit. Bake biscuits on a glass tray lined with greaseproof paper.
- Since microwaves penetrate foods about two centimetres from the top, bottom and sides, mixtures in round shapes and rings cook more evenly. Corners receive more energy and may overcook.
- Items with a lot of water, such as rice and pasta, cook in about the same time as they would on a conventional stove. (Refer to Rice and Pasta chapter.)

Select recipes that convert easily to microwave cooking such as casseroles, stews, baked chicken, fish and vegetable dishes. The results from foods such as grilled meats, cooked souffles or two-crust pies could be less than satisfactory. Never attempt to deep fry in your microwave oven.

Microwave Recipe Techniques (continued)

Menu Planning for Microwave Cooking

How to Keep Everything Hot at The Same Time

Plan your meals so that the food will not all need last minute cooking or attention at the same time. The special features of microwave cookery make it easy to serve meals with everything piping hot. Cooking of some foods may be interrupted while you start others, without harming the nutritional value or flavour of either.

A recipe which requires standing time can be microwaved first and another food cooked while it stands. Dishes prepared in advance can be reheated briefly before serving.

It does take some experience and time to cook with confidence. Microwaves are fast so you will have to do some experimenting. You might find you will use your conventional range in conjunction with your microwave oven. For example, while cooking the roast in the microwave oven, you can be cooking the vegetables and gravy on the range top. This can also be done the other way around. Prepare your meals as follows.

1. Firstly, cook the most dense item (roast or casserole). Drain and retain meat juice from joints then cover with foil.
2. Cook the potatoes, rice or pasta.
3. Cover with foil for standing.
4. Cook greens and other vegetables.
5. Cover with foil for standing.
6. Cook the gravy with the retained meat juices, stock and thickening.
7. Carve the roast and serve the vegetables and gravy.

While you are learning to plan meals, you may get a bit behind time. Don't worry. Dinner servings may be suitably reheated on 800 W, for 1 to 2 minutes per serving.

If you prefer not to use foil, cover food with saucepan lids. A metal lid will retain the heat for at least 15 minutes.

Meanwhile, how can you cook all the vegetables at the same time? Simply place potatoes and pumpkin in one dish and less dense vegetables such as broccoli, cabbage, cauliflower, beans and peas in another. Sprinkle greens with water. Cover with a lid or plastic wrap. Cook on 1000 W for approximately 6 to 8 minutes for a serving for four people. Remember, if you increase the quantity of vegetables, increase the cooking time. Fresh and frozen vegetables can be mixed on a vegetable platter, but remember the latter are not as dense as fresh vegetables, as they have been blanched before freezing.

If vegetables are cut to a similar size, they can be cooked in separate ramekins or small dishes at the same time.

Increasing & Decreasing Recipes

Increasing

- To increase a recipe from 4 to 6 servings, increase each ingredient listed by half.
- To increase a recipe from 4 to 8 servings, double each ingredient listed.
- For larger quantities of a recipe, a large dish should be used. Make sure that the dish is deep enough to prevent the recipe from boiling over during cooking.
- Make sure to cover, stir or rearrange food as directed in the recipe and always check the food during cooking.
- Increase standing times by 5 minutes per 500g.
- Use the same Power Level recommended in the original recipe.
- Increase the cooking times by: $\frac{1}{3}$ of original cooking time for 6 servings; and an extra $\frac{1}{2}$ of original cooking time for 8 servings.

Decreasing

- To decrease a recipe from 4 to 2 servings, decrease each ingredient listed by half.
- For small quantities, a small dish should be used. Make sure that the dish is large enough to prevent the recipe from boiling over during cooking.
- Use the same Power Level recommended in the original recipe.
- Decrease the cooking times by $\frac{1}{2}$ to $\frac{2}{3}$ of the original cooking time.

Cooking for One

- To decrease a recipe from 4 to 1 serving, quarter each ingredient listed.
- A smaller dish should be used, making sure that the dish is still large enough to prevent the recipe from boiling over.
- Use the same Power Level recommended in the original recipe.
- Quarter the original cooking times, then add extra time, if needed.
- Make sure to cover, stir or rearrange food as directed in original recipe and always check the food during cooking.

Converting Recipes from Other Sources

When the recipe is written with a wattage different than your oven, adjust the cooking time by approximately 10% per 100 watts, e.g. 10 minutes would be adjusted by 1 minute. Alternately, adjust the power level by one level. If your wattage is higher than the recipe: (1) Adjust time downward or (2) Adjust power level downward. If your wattage is lower than the recipe: (1) adjust time upward or (2) adjust power level upward (when possible).

Basic Recipes

GRANOLA CEREAL

Makes: approximately 4 cups

Ingredients:

2 cups	oats
$\frac{2}{3}$ cup	chopped nuts
$\frac{1}{3}$ cup	wheat germ
$\frac{1}{4}$ cup	brown sugar
$\frac{1}{4}$ cup	honey
1 teaspoon	vanilla essence
$\frac{1}{3}$ cup	raisins
$\frac{1}{3}$ cup	coconut

Method:

1. Place oats in 3-litre casserole dish, cook on 1000 W for 1 to 2 minutes, stirring twice.
2. Add nuts, wheat germ, and brown sugar. Stir in honey and vanilla. Cook on 1000 W for 2 to 4 minutes, stirring twice during cooking.
3. Add raisins, coconut and allow to cool. Stir to a crumble texture. Store in an airtight container.

TOMATO AND ONION

Serves 4

Ingredients:

approx. 3	tomatoes, thinly sliced
1	onion, thinly sliced
$\frac{1}{2}$ teaspoon	basil
	salt and pepper to taste

Method:

1. Place all ingredients into 2-litre casserole dish.
2. Cook, covered, on 1000 W for 5 to 7 minutes. Serve with barbecued steak or grilled meat.

SCRAMBLED EGGS

Serves: 2

Ingredients:

4 x 61 g	eggs
4 tablespoons	milk
	pinch of salt

Method:

1. In a 2-litre casserole dish, beat eggs lightly with whisk. Add milk and salt. Whisk until well combined. Cover dish with plastic wrap and cook on 600 W for 2 minutes.
2. Stir eggs and cook for further $1\frac{1}{2}$ to 2 minutes. Stand, covered, for 1 minute before serving.

HINT:

TO COOK BACON RASHERS:

Place bacon between 2 sheets of paper towel on a pie plate and cook on 1000 W for 2 to 3 minutes.

HINT:

TO COOK PAPPADUMS:

Place on paper towel lined microwave safe plate. Cook on 1000 W for 10 to 20 seconds for each pappadum, turning halfway through cooking. Allow to stand 1 minute before serving.

LEMON LIME CORDIAL

Makes: approximately 1.5 litres of undiluted cordial

Ingredients:

10	large lemons
6	limes
4 cups	sugar
2 cups	water
2 teaspoons	citric acid

Method:

Squeeze juice from lemons and limes. Place in a 3 to 4-litre dish with the remaining ingredients. Cook on 1000 W for 8 to 10 minutes. Stir every 2 minutes during this cooking time to dissolve sugar. Cook on 1000 W for 25 to 30 minutes, or until the mixture has become a syrupy consistency. Set aside to cool. Pour into bottles and seal. Store in the refrigerator and serve with cold water, soda or mineral water and fresh mint leaves if desired.

GRAVY

Makes: 2 cups (500 ml)

Ingredients:

2 tablespoons	dripping or pan juice
1	small onion, finely chopped
2 tablespoons	flour
1 tablespoon	tomato paste
$1\frac{1}{2}$ cups	beef stock, divided
	salt and pepper

Method:

1. Place dripping or pan juices and onion in a 1-litre jug. Cook on 1000 W for 2 to 3 minutes.
2. Add flour, tomato paste and half of the beef stock. Stir well. Cook on 1000 W for 2 minutes. Add remaining stock.
3. Stir well and cook on 1000 W for a further 2 minutes. Season with salt and pepper. Serve with the meat of your choice.

BASIC WHITE SAUCE

Makes: 1 cup

Ingredients:

2 tablespoons	butter
2 tablespoons	flour
	salt and white pepper
$1\frac{1}{4}$ cups	milk

Method:

1. Place butter in a 4-cup jug. Cook on 1000 W for 30 to 40 seconds.
 2. Stir in flour, salt and pepper. Gradually add milk, stirring until smooth.
 3. Cook on 1000 W for 3 to 4 minutes, stirring twice.
- Tip:** For cheese sauce, stir in $\frac{1}{2}$ cup grated cheese once sauce has thickened.

HINT:

TO DRY FRESH BREADCRUMBS:

Place 1 cup (250 ml) of breadcrumbs on the base of plate and heat on 1000 W for 2 to 3 minutes, stirring once during heating.

Soups and Snacks

CHICKEN AND PRAWN LAKSA

Serves: 4

Ingredients:

Soup:

2 tablespoons laksa paste
400 ml coconut milk
1 litre chicken stock
1 tablespoon soy sauce
fresh ground black pepper

Laksa:

250 g rice noodles
8 cups boiling water
1 bunch coriander, leaves chopped
4 small red chillies, seeds removed and finely chopped
½ cup bean sprouts
4 lime wedges
1 tablespoon peanut oil
400 g cooked chicken tenderloins, sliced
12 green king prawns, peeled

Method:

Soup:

Place the laksa paste, coconut milk, stock, soy sauce and pepper into a 3-litre dish and cook covered on 1000 W for 10 to 12 minutes.

Laksa:

Place the noodles and water in a 4 litre dish. Cover and cook on 1000 W for 2 to 3 minutes, stirring halfway through. Drain well and divide between 4 deep bowls. Place the coriander, chillies, bean sprouts and lime on top. Place the peanut oil and prawns in a 1-litre dish and cook on 600 W for 3 to 5 minutes, stirring halfway through. Add the chicken and prawns to each individual bowl and set aside.

To serve:

Heat soup on 1000 W for 2 minutes. Pour the hot soup over the ingredients in the 4 bowls and serve.

ZUCCHINI SLICE

Serves: 4 to 6

Ingredients:

4 rashers bacon, diced
1 onion, diced
2 cups grated zucchini
2 cups grated carrot
1 cup grated tasty cheese
1 cup self raising flour
5 eggs, lightly beaten
125 ml vegetable oil
1 tablespoon fresh chopped parsley
salt and pepper

Method:

Lightly grease a 25 cm square microwave safe dish. Place bacon and onion in a 2-litre casserole dish and cook on 1000 W for 2 to 3 minutes. Allow to cool slightly. Stir in zucchini, carrot and cheese and flour. In a 1-litre bowl whisk together eggs, oil and parsley. Add to bacon mixture season with salt and pepper and stir until combined. Pour into prepared dish. Cook on 600 W for 30 to 35 minutes.

NACHOS SUPREME

Serves: 4 to 6

Ingredients:

500 g topside mince
35 g packet taco seasoning mix
⅓ cup tomato paste
1 teaspoon Mexican chilli powder
310 g red kidney beans, mashed in liquid
180 g packet corn chips
1 avocado
½ cup sour cream
½ cup grated cheese
paprika

Method:

Place meat in a 2-litre dish. Cover and cook on 1000 W for 6 to 8 minutes, stirring halfway through. Mix with fork, breaking up any large pieces of meat. Add taco mix, tomato paste, chilli powder and kidney beans. Cook on 600 W for further 10 minutes, stirring halfway through cooking. Place corn chips in a 3-litre microwave suitable serving dish. Pile meat sauce in the centre. In a small bowl, mash avocado and mix in sour cream. Spoon this mixture over meat sauce and top with grated cheese. Sprinkle with paprika. Heat on 600 W for 3 to 4 minutes.

NUTS AND BOLTS

Serves: 6 to 8

Ingredients:

80 g butter
2 teaspoons curry powder
2 tablespoons worcestershire sauce
½ teaspoon salt
¼ teaspoon garlic powder
100 g packet mixed rice crackers
100 g fried noodles
200 g salted peanuts
125 g packet pretzel sticks
½ cup Nutri-Grain

Method:

Place butter, curry, worcestershire sauce, salt and garlic powder in a 3-litre casserole dish. Cook on 1000 W for 2 to 3 minutes. Add remaining ingredients, mix well and cook on 1000 W for 4 to 5 minutes. Stir twice through cooking. Allow to cool. Place in a bowl and serve with drinks. Store in an airtight container once cool.

Soups and Snacks (continued)

PUMPKIN SOUP

Serves: 4

Ingredients:

1 kg	pumpkin diced
1	onion, diced
2 cups	chicken stock
1 teaspoon	curry powder
	pepper

Method:

Place pumpkin and onion in a 3-litre casserole dish. Cover and cook on 1000 W for 12 to 14 minutes. Add chicken stock, curry powder and pepper. Cook on 1000 W for 10 minutes. Cool slightly. Purée pumpkin and liquid in blender or food processor. Pour into individual serving dishes and garnish with chives.

SHORT AND LONG SOUP

Serves: 4

Ingredients:

200 g	fresh singapore noodles
12 (200 g)	frozen mini dim sims
4	green onions, sliced
1 litre	chicken stock
1 teaspoon	crushed garlic
½ teaspoon	chopped ginger
2 tablespoons	soy sauce
1	chicken breast, cooked and sliced
4	baby bok choy, quartered
1 cup	bean sprouts
2 tablespoons	dried onion (optional)

Method:

Place all ingredients except bok choy and bean sprouts in a 4 litre casserole dish and cook on 1000 W for 12 to 14 minutes. Add bok choy and cook on 1000 W for 4 to 6 minutes. Serve in individual bowls topped with bean sprouts and onion.

HINT:

To cook 1 double chicken breast. Place onto a dinner plate. Cover and cook on 600 W for 8 to 10 minutes.

PEA AND HAM SOUP

Serves: 6

Ingredients:

2½ cups	green split peas
850 g	smoked ham hock
1	medium onion, chopped
1 tablespoon	fresh thyme leaves
1	bay leaf
6 cups	chicken stock
½ cup	frozen peas

Method:

Wash split peas and place in a 2-litre capacity bowl with 1-litre of water. Cover and allow soaking for 8 hours or overnight. Remove rind from ham hock and discard. Cut meat away from the bone and roughly chop. Reserve bone. Drain peas and place into a 4-litre capacity microwave safe dish. Add ham bone, chopped ham, onion, thyme, bay leaf and chicken stock. Cook uncovered on 1000 W for 15 minutes. Reduce power to 600 W and cook for 20 minutes. Skim top of soup and cook on 600 W for a further 60 minutes. Remove ham bone and bay leaf and stir in frozen peas. Cook on 600 W for 10 minutes. Blend half the soup and return to the bowl, stirring through the remaining soup. Serve hot with crusty bread.

Tip:

Substitute 500 g bacon bones and 250 g of diced bacon rashers for the ham hock.

Do not add salt when cooking lentils or pulses, as they will toughen. Add salt after cooking if desired.

POTATO AND LEEK SOUP

Serves: 4 to 6

Ingredients:

800 g	potatoes, peeled and diced
1½ cups	thinly sliced leeks
2 teaspoons	fresh thyme
	pepper
2 cups	chicken stock
150 ml	cream

Method:

Place potatoes, leeks, thyme and pepper in 4-litre casserole dish. Cover and cook on 1000 W for 8-10 minutes. Stir in chicken stock. Cover and cook on 1000 W for 14 to 16 minutes. Purée soup mixture. Stir in cream and serve hot or cold in individual bowls.

Fish and Shellfish

Directions for Cooking Fish and Shellfish by Micro Power

Clean fish before starting the recipe. Arrange fish in a single layer, do not overlap edges. Prawns and scallops should be placed in a single layer.

Cover dish with plastic wrap. Cook on the power level and for the minimum time recommended in the chart below. Halfway through cooking rearrange or stir prawns or scallops.

Cooking Fish and Shellfish by Micro Power

FISH OR SHELLFISH	AMOUNT	POWER	APPROX. COOKING TIME (in minutes)
Fish Fillets	500 g	600 W	6 to 8
Scallops (sea)	500 g	600 W	6 to 8
Green Prawns medium size (shelled and cleaned)	500 g	600 W	6 to 8
Whole Fish (stuffed or unstuffed)	500 g to 900 g	600 W	8 to 10

LEMON PEPPER FISH

Serves: 2

Ingredients:

300 g fish fillets
 ¼ cup lemon juice
 1 teaspoon black pepper

Method:

- Place fish fillets, lemon juice and black pepper in a 2-litre casserole dish.
- Cover with plastic wrap and cook on 600 W for 4 to 6 minutes.
- Let stand for 3 minutes before serving.

SWEET SCALLOP STIR FRY

Serves: 2 to 4

Ingredients:

1 tablespoon oil
 1 onion, quartered
 ½ teaspoon crushed garlic
 ½ red capsicum sliced
 2 sticks celery sliced
 2 tablespoons sliced water chestnuts
 100 g snow peas
 1 tablespoon honey
 1 tablespoon sweet chilli sauce
 1 tablespoon chopped coriander
 500 g scallops

Method:

- Place oil, onion and garlic into a 2-litre dish. Cook on 1000 W for 1-2 minutes.
- Add remaining ingredients and cook on 1000 W for 5-7 minutes, stir halfway through cooking.
- Serve immediately.

GARLIC & CHILLI PRAWNS

Serves: 4

Ingredients:

1 kg medium uncooked king prawns
 1 small red onion, thinly sliced
 40 g butter
 3 garlic cloves, crushed
 2 fresh bird's eye chillies, deseeded & finely chopped
 ½ small red capsicum, finely sliced
 100 g snow peas, trimmed
 1 tablespoon lemon juice
 80 ml thickened cream
 ¼ cup coriander leaves, chopped
 Cooked jasmine rice, to serve

Method:

Peel and de-vein prawns leaving tails in tact, set aside. Place onion, butter, garlic and chilli into a 3Litre microwave safe dish. Cook on 1000 W for 2 to 3 minutes, stir halfway through cooking. Add prawns and mix to combine. Cook on 800 W for 3 minutes. Stir in capsicum and snow peas, cover and cook on 800 W for a further 3 minutes. Stir through lemon juice, cream and coriander, season and cook on 1000 W for 1 minute. Serve immediately with cooked rice.

Fish and Shellfish (continued)

SPICED WHOLE BREAM

Serves: 2

Ingredients:

2 x 400 g	whole bream
1 clove	garlic
3 stalks	coriander
1	red birds eye chilli
1 tablespoon	freshly chopped ginger
1 tablespoon	lime juice
2 teaspoons	fish sauce
2 teaspoons	brown sugar
2	green onions, sliced

Method:

Clean and scale fish, set aside. Process remaining ingredients in a food processor to form a paste. Rub the spice paste into the fish and place them in a microwave safe dish. Cook on 600 W for 12 to 15 minutes.

SALMON MORNAY

Serves: 4

Ingredients:

40 g	butter
1	onion, diced
¼ cup	flour
1 tablespoon	chopped fresh parsley
	pepper
½ teaspoon	prepared mustard
1½ cups	milk
440 g	can salmon and liquid
½ cup	fresh bread crumbs
⅓ cup	grated cheese

Method:

Place butter and onion in a 4-cup jug. Cook on 1000 W for 1 minute. Add flour and cook on 1000 W for 1 minute. Add parsley, pepper, mustard and gradually blend in milk. Cook on 1000 W for 2 to 3 minutes, stir halfway through cooking. Lightly mix through salmon and liquid into sauce. Pour into serving dish and top with bread crumbs and cheese. Cook for further 4 to 5 minutes on 1000 W.

GARLIC PRAWNS

Serves: 2

Ingredients:

60 g	butter
2	clove garlic, crushed
1 tablespoon	lemon juice
1 tablespoon	chopped parsley
500 g	peeled green prawns

Method:

Place butter and garlic in a 2-litre dish and cook on 1000 W for 30 to 50 seconds. Add lemon juice, parsley and prawns, cover with plastic wrap, cook on 600 W for 6 to 8 minutes, stirring halfway through cooking. Serve in individual ramekins.

SALMON STEAKS WITH LIME BUTTER

Serves: 4

Ingredients:

30 g	butter
1	clove garlic, crushed
1 teaspoon	grated fresh ginger
1 teaspoon	grated lime rind
2 tablespoons	lime juice
½ teaspoon	sugar
500 g	salmon, steaks

Method:

Place butter, garlic, ginger, lime rind, juice and sugar in a shallow dish. Cook on 800 W for 1 to 2 minutes. Stir halfway through cooking. Add salmon steaks and coat with sauce. Cover and cook on 600 W for 8 to 10 minutes. Stand for 2 to 3 minutes before serving.

OYSTER SOUP

Serves: 4 to 6

Ingredients:

30 g	butter
2 tablespoons	flour
2 cups	chicken stock
½ cup	cream
20	bottled oysters, drained
	salt and white pepper
	snipped chives to garnish

Method:

Place butter in 2-litre casserole dish and cook on 1000 W for 1 minute. Add flour, stir well and cook on 1000 W for 30 seconds. Gradually add stock, stirring continuously. Cook on 1000 W for 5 to 7 minutes, stirring halfway through cooking. Add cream, oysters, salt and pepper. Cook on 800 W for 1 to 2 minutes. Spoon into individual dishes and garnish with chives.

SEAFOOD MARINARA

Serves: 4

Ingredients:

750 g	Marinara mix
2 tablespoons	butter
1	clove garlic, crushed
2	tomatoes, peeled and chopped
1 tablespoon	tomato paste
¼ cup	white wine
¼ cup	fresh basil leaves, chopped
	pepper

Method:

Place marinara mix into a 2-litre casserole dish. Set aside. Place butter and garlic in 1-litre casserole dish. Cook on 800 W for 1 minute. Add remaining ingredients (except seafood), to dish and cook on 1000 W for 5 minutes. Purée tomato mixture in blender or food processor and pour over seafood. Cook on 800 W for 7 to 9 minutes, stir halfway through cooking. Stand for 5 minutes. Serve with salad and pasta.

Poultry

Cooking Whole Poultry by Micro Power

Season as desired, but salt after cooking. Browning sauce mixed with equal parts of butter will enhance the appearance.

Poultry may be stuffed or unstuffed. Tie legs together with cotton string. Place on a microwave rack set in a rectangular dish. Place poultry breast-side down: turn over halfway through cooking. Cover with wax paper to prevent splattering.

If the poultry is not cooked enough, return it to the oven and cook a few more minutes at the recommended power level.

DO NOT USE A CONVENTIONAL MEAT THERMOMETER IN THE MICROWAVE OVEN.

Let stand, covered with foil, 10 to 15 minutes after cooking. Standing time allows the temperature to equalize throughout the food and finishes the cooking process.

If a large amount of juice accumulates in the bottom of the baking dish, occasionally drain it. If desired, reserve juices for making gravy.

Less-tender birds should be cooked in liquid such as soup or broth. Use $\frac{1}{4}$ cup per 500g of poultry.

Use an oven cooking bag or a covered casserole.

Select a covered casserole deep enough so that bird does not touch the lid.

If an oven cooking bag is used, prepare according to package directions. Do not use wire twist-ties to close bag. Use only nylon tie, a piece of cotton string, or a strip cut from the open end of the bag. Make six 2 cm slits on top of bag.

Multiply the weight of the poultry by the minimum recommended minutes per 500 g. Programme Micro Power and Time.

After cooking, check the internal temperature of the bird with a microwave or conventional meat thermometer inserted into the muscle. Check temperature in both muscles. The thermometer should not touch bone. If it does, the reading could be inaccurate. A thermometer cannot be accurately inserted into a small bird. To check desired cooking of a small bird, juices should be clear and the drumsticks should readily move up and down after standing time. During cooking, it may be necessary to shield legs, wings and the breast bone with foil to prevent overcooking. Wooden toothpicks can be used to hold foil in place.



Cooking Poultry Pieces by Micro Power

Cover with wax paper or paper towel. Use the chart below to determine recommended minimum cooking times.

Arrange pieces skin-side down and evenly spread in a shallow dish.

Turn or rearrange halfway through cooking. Shield wing tips, drumstick ends etc., if required.



Cooking Poultry by Micro Power

POULTRY	POWER	TEMPERATURE AFTER COOKING	APPROX. COOKING TIME (minutes per 500 g)
Chickens	600 W	87°C	10 to 15
Chicken (pieces)	600 W	87°C	8 to 10
Turkey	600 W	87°C	12 to 17
Duck	600 W	87°C	10 to 15

Poultry (continued)

CHICKEN SAN CHOY BAU

Serves: 4

Ingredients:

10	dried chinese mushrooms
2 teaspoons	sesame oil
1	clove garlic, chopped
500 g	minced chicken
10	water chestnuts, finely chopped
227 g	bamboo shoots, chopped
1 tablespoon	soy sauce
2 teaspoons	oyster sauce
2 tablespoons	sherry
1	small iceberg lettuce

Method:

1. Cover mushrooms with boiling water, stand for 30 minutes. Drain, remove stems and chop finely.
2. Place oil and garlic in a 2.5-litre casserole dish, cook on 1000 W for 50-60 seconds.
3. Add chicken and cook on 600 W for 10-12 minutes. Add remaining ingredients except lettuce and cook on 600 W for 6-8 minutes.
4. Separate lettuce leaves, place tablespoons of mixture into each lettuce leaf. Serve immediately.

THAI RED CHICKEN CURRY

Serves: 4

Ingredients:

1	onion, chopped
2 tablespoons	red curry paste
500 g	chicken fillets, chopped
2 cups	finely sliced vegetables
1 cup	coconut milk

Method:

1. Place onion and curry paste in 3-litre casserole dish. Cook on 1000 W for 3 to 4 minutes.
2. Add chicken and combine. Cook on 600 W for 8 to 10 minutes, stirring once during cooking.
3. Add vegetables and coconut milk. Stir well. Cover and cook on 1000 W for 4 minutes. Serve with Jasmine rice.

CHICKEN AND ASPARAGUS RISOTTO

Serves: 4

Ingredients:

300 g	fresh asparagus, chopped
2 tablespoons	olive oil
1½ cups	arborio rice
1	clove garlic, crushed
4 cups	boiling chicken stock
2 cups	coarsely chopped cooked chicken
¼ cup	grated fresh parmesan cheese
¼ cup	cream
	ground black pepper
1 tablespoon	chopped parsley
extra	coarsely grated parmesan cheese

Method:

Place asparagus into 2-litre dish and cook on 1000 W for 1 to 2 minutes. Set aside. Place oil, rice and garlic in a large microwave safe bowl. Cook covered on 1000 W for 1 to 2 minutes. Add 2 cups of boiling chicken stock, cook on 1000 W for 5 minutes. Stir twice during cooking. Add remaining chicken stock and cook on 1000 W for another 5 minutes. Add remaining ingredients along with asparagus and stir into risotto. Cook covered on 1000 W for 2 minutes. Stand for 5 minutes. Serve topped with extra parmesan and black pepper.

GREEN PEPPERCORN CHICKEN

Serves: 4

Ingredients:

4	small single chicken breast fillets
2 tablespoons	green peppercorns
1 tablespoon	seeded mustard
1 teaspoon	chicken stock powder
2 tablespoons	lemon juice
½ cup	cream

Method:

1. Slice chicken fillets. Place chicken in a shallow 2-litre dish and cook on 600 W 8-10 minutes. Stir halfway through cooking.
2. Mix together remaining ingredients. Add to chicken, stir well. Cook on 1000 W for 2 to 3 minutes. Serve sauce over chicken.

CHICKEN CACCIATORE

Serves: 4

Ingredients:

440 g can	tomatoes
¼ cup	tomato paste
1 teaspoon	minced garlic
1	onion, diced
2 teaspoons	dried oregano
1 kg	chicken drumsticks

Method:

1. Place all ingredients in a 3-litre casserole dish. Stir until combined. Cover and cook on 600 W for 15 to 18 minutes.
2. Turn chicken and stir. Cook on 600 W for 15 to 18 minutes.

Main Fare Meats

Cooking Tender Cuts of Meat by Micro Power

For best results, select roasts that are uniform in shape. Place meat on a microwave rack in a suitable dish. Beef rib roast should be placed cut-side down. Other bone-in roasts should be placed fat-side down. Boneless roasts should be placed fat-side up. Halfway through cooking, turn roasts. Half hams should be shielded by wrapping an 8 cm wide strip of foil around the large end of the ham. Secure to the body of the ham with wooden toothpicks. Fold 3 cm over cut surface. For shank ham halves, shield shank bone by cupping it with foil. One third of the way through cooking, remove ham from oven and cut off skin. Turn fat side up and reshield edges. If desired, glaze last 10 to 20 minutes of cooking. Loosely cover baking dish with wax paper or paper towel to prevent splatter. If a large amount of juice accumulates in the bottom of the dish, drain occasionally. If desired, reserve for making gravy. Multiply the weight of the roast by the minimum recommended times per 500 g. Programme Micro Power and Time. Meats can be shielded at the beginning of cooking or halfway through cooking. If you wish to shield at the

beginning of cooking, remove foil halfway through the cooking time. Beef and pork rib roasts should be shielded around the bones. Foil should extend about 5 cm down from bones. The shank and thin ends of boneless roasts should also be shielded. Make sure foil does not touch the sides of the oven, as arcing may occur. Canned hams should be shielded on the top cut-edge with a 3 cm strip of foil. Wrap strip of foil around ham and secure to body of ham with wooden toothpicks. Fold 2 cm over cut surface. After heating, check temperature using a meat thermometer. The thermometer should not touch bone or fat. If it does, the reading could be inaccurate. Lower temperatures are found in the centre of the roast and in the muscle close to a large bone, such as a pork loin centre rib roast. If the temperatures are low, return meat to the oven and cook a few more minutes at the recommended power level. **DO NOT USE A CONVENTIONAL MEAT THERMOMETER IN THE MICROWAVE OVEN.** Let stand, covered with foil, 10 to 15 minutes. During standing time the internal temperature equalises and the temperature rises 5°C to 10°C.

Directions for Cooking Less-Tender Cuts of Meat by Microwave

Less-tender cuts of meat such as pot roasts should be cooked in liquid. Use ½ to 2 cups of soup, broth, etc. per 500 g of meat. Use an oven cooking bag or covered casserole when cooking less-tender cuts of meat. Select a covered casserole deep enough so that the meat does not touch the lid. If an oven cooking bag is used, prepare the bag according to package directions. Do not use wire or metal twist-

ties. Use the nylon tie provided, otherwise, use a piece of cotton string or a strip cut from the open end of the bag. Make six 2 cm slits in top of bag to allow steam to escape. Multiply the weight of the roast by the minimum recommended minutes per 500g as suggested in the chart below. Programme Power and Time. Turn meat over halfway through cooking. Meat should be tender when cooked.

Meat Chart for Microwave Cooking

MEAT	POWER	APPROX. COOKING TIME (minutes per 500 g)
Beef		
Roasts Medium		
Rare	800 W	10 to 12
Medium	800 W	12 to 14
Well	800 W	14 to 16
Pot Roast	300 W	25 to 30
Pork		
Leg of Pork	800 W	11 to 13
Loin of Pork	800 W	11 to 13
Ham Canned (fully cooked)	800 W	4 to 5
Lamb		
Medium	800 W	8 to 10
Well	800 W	12 to 14

Main Fare Meats (continued)

CHILLI BEEF

Serves: 4

Ingredients:

500 g	minced beef
1	onion, diced
1	clove garlic, crushed
35 g	packet chilli seasoning mix
410 g	can tomato puree
420 g	can kidney beans, drained

Method:

1. Place all ingredients in a 3-litre casserole dish. Mix well. Cook on 800 W for 20-25 minutes. Stir halfway through cooking.
2. Serve in taco shells or in tortillas with salad and cheese.

CHINESE BEEF AND VEGETABLES

Serves: 4

Ingredients:

400 g	rump steak, sliced
1 teaspoon	chopped ginger
1	clove garlic, crushed
1 tablespoon	soy sauce
2 tablespoons	Hoi Sin sauce
¼ cup	beef stock
2 cups	sliced vegetables

Method:

1. Place steak, ginger and garlic in a 3-litre casserole dish. Cook on 1000 W for 1-2 minutes.
2. In a 1 cup jug combine sauces with stock. Add to meat mixture. Cook on 1000 W for 2-3 minutes.
3. Add vegetables and cook on 1000 W for 4-5 minutes, stirring halfway through cooking.
4. Let stand for 5 minutes before serving with rice or noodles.

BEEF STROGANOFF

Serves: 4

Ingredients:

1	onion, sliced
500 g	rump steak sliced into ribbons
2 tablespoons	tomato sauce
2 tablespoons	worcestershire sauce
1	beef stock cube
⅓ cup	sour cream
200 g	sliced mushrooms

Method:

1. Place all ingredients (except sour cream and mushrooms) in 3-litre casserole dish. Stir until combined.
2. Cook on 800 W for 10 to 12 minutes, stirring once during cooking. Add sour cream and mushrooms.
3. Stir and cook on 600 W for 4 to 5 minutes.

SPAGHETTI MEAT SAUCE

Serves: 4

Ingredients:

500 g	minced beef
1	onion, diced
1	clove garlic, crushed
420 g	can tomatoes
½ cup	tomato paste
2 tablespoons	chopped basil

Method:

1. Combine all ingredients in a 3-litre casserole dish. Cook on 1000 W for 7-8 minutes, stir.
2. Cook on 600 W for 20-24 minutes. Stirring halfway through cooking.
3. Serve over hot spaghetti.

FRENCH ONION BEEF CASSEROLE

Serves: 4

Ingredients:

1	onion, diced
1 teaspoon	mixed dried herbs
200 g	diced potatoes
500 g	chuck steak, cubed
20 g	french onion soup mix
⅓ cup	tomato puree
2 cups	beef stock

Method:

1. Place onion and herbs in a 3-litre casserole dish. Cook on 1000 W for 1-2 minutes.
2. Add remaining ingredients, stir until combined. Cover and cook on 1000 W for 10 minutes.
3. Stir and cook on 600 W for 20-25 minutes, stirring once during cooking.
4. Let stand 5 minutes before serving.

THAI BEEF CURRY

Serves: 4 to 6

Ingredients:

1	onion, thinly sliced
2 tablespoons	Thai green curry paste
500 g	thinly sliced lean beef
½	red capsicum, thinly sliced
1	carrot, thinly sliced
1	zucchini, sliced
200 g	broccoli, broken into flowerets
1 cup	coconut milk
1 tablespoon	soy sauce
1 tablespoon	lemon juice
2 tablespoons	shredded fresh basil
½ cup	roasted unsalted peanuts

Method:

Place the onion and curry paste into a 4-litre dish. Cook on 1000 W for 2 to 3 minutes. Add the beef and cook on 1000 W for 4 to 6 minutes, stirring halfway through cooking. Add the vegetables and coconut milk and cook on 1000 W for 6 to 8 minutes. Mix in the soy sauce, lemon juice and basil and serve sprinkled with peanuts.

Main Fare Meats (continued)

MUSSAMAN BEEF CURRY

Serves: 4

Ingredients:

500 g	round steak diced
1/3 cup	mussaman curry paste
400 g	potato diced
250 ml	coconut milk
250 ml	beef stock
1 tablespoon	brown sugar

Method:

Place steak, curry paste and potato in a 3-litre casserole dish cook on 1000 W for 6 minutes. Add coconut milk, beef stock and brown sugar, stir, cook on 100 W for 40 minutes. Stir once during cooking serve with jasmine rice.

LAMB PILAF

Serves: 4

Ingredients:

1 tablespoon	oil
1	large onion, sliced
600 g	lean lamb, diced
400 g	can tomato pieces
2 teaspoons	garam masala
1 teaspoon	dried thyme
1 cup	long grain rice
600 ml	hot chicken stock
150 g	natural yoghurt
	freshly ground black pepper

Method:

Place the oil and onion in a 3 litre dish. Cover and cook on 1000 W for 2 to 3 minutes. Add lamb, tomato pieces, garam masala, and thyme. Cover and cook on 800 W for 10 minutes. Stir. Cook on 800 W for a further 10 minutes. Add the rice and chicken stock and cook covered on 440 W for a further 30 minutes or until the rice is tender. Stir in yoghurt, season with pepper and serve.

CORNED BEEF

Serves: 4

Ingredients:

1.5 to 1.7 kg	corned silverside
1 tablespoon	brown sugar
1 tablespoon	white vinegar
1	onion, cut in half
4	cloves
6	peppercorns
1	bay leaf
5 cups	water

Method:

Rinse corned silverside under cold running water to remove excess salt. Place corned silverside in 4-litre casserole dish. Add remaining ingredients. Cover and cook on 1000 W for 10 minutes. Turn meat, cover and cook on 100 W for 1 1/4 to 1 1/2 hours. Stand corned silverside in cooking liquid for 10 minutes before carving.

Note: Depending on the size and shape of the silverside, it may require a further 10 to 15 minutes on 100 W.

GINGERED PORK STIR FRY

Serves: 4

Ingredients:

500 g	sliced lean pork
1/4 cup	teriyaki sauce
1 tablespoon	honey
2 teaspoons	minced ginger
2 teaspoons	cornflour
1	onion, sliced
300 g	sugar snap peas, trimmed
1	zucchini, sliced
1/2	red capsicum, sliced
2	green onions, sliced
1/2 cup	bean sprouts
1 tablespoon	toasted sesame seeds

Method:

Place pork, teriyaki sauce, honey, ginger and cornflour in a 2-litre dish. Cover and marinate in the refrigerator for 2 hours. Place onion in a 3 litre dish. Cook on 1000 W for 1 to 2 minutes. Add marinated pork and sauces and cook on 800 W for 3 to 4 minutes. Add peas, zucchini, capsicum, green onions and bean sprouts. Cook on 1000 W for 3 to 4 minutes. Sprinkle with sesame seeds and serve with noodles.

LAMB KORMA

Serves: 4

Ingredients:

1	onion, diced
500 g	lamb, cubed
1/3 cup	korma curry paste
2 cups	carrots sliced
250 ml	tomato puree
250 ml	beef stock
2 tablespoons	natural yoghurt

Method:

Place onion, lamb, curry paste and carrot in a 3-litre casserole dish. Cook on 1000 W for 6 minutes. Add tomato puree and beef stock and stir, cook on 600 W for 35-38 minutes, stirring once during cooking. Stir in yoghurt and serve with basmati rice.

BEEF BOURGUIGNONNE

Serves: 4 to 6

Ingredients:

750 g	diced chuck steak
4 rashers	bacon, diced
6	pickling, onions
2 teaspoons	minced garlic
1/4 cup	red wine
410 ml	tomato puree
1/2 cup	beef stock
1 teaspoon	minced chilli
1 teaspoon	dried tarragon
250 g	button mushrooms, halved

Method:

Place all ingredients except mushroom in a 3-litre casserole dish, stir until combined. Cover and cook on 600 W for 14 to 16 minutes. Stir and cook on 100 W for 28 to 30 minutes. Stir and add mushrooms halfway through cooking.

Vegetable Varieties

Directions for Cooking Vegetables

FRESH VEGETABLES BY MICRO POWER

Place vegetables in a casserole dish. Add 2 to 3 tablespoons of water per 500 g of vegetables. Add salt to water or add after cooking. Do not place salt directly on vegetables. Cover dish with glass lid or plastic wrap.

Cook on 1000 W according to time recommended in charts. Halfway through cooking, stir, turn vegetables over or rearrange.

Vegetables that are to be cooked whole and unpeeled, need to be pierced to allow steam to escape. Place vegetables on a paper towel lined dinner plate. Allow to stand, covered, according to the time indicated in the charts.

FROZEN VEGETABLES BY MICRO POWER

Remove vegetables from package and place in an appropriate sized container. Vegetables frozen in a

pouch should be placed on a dish and the top pierced. Cook on 1000 W according to directions given in chart. Vegetables should be cooked covered with a lid or plastic wrap.

Halfway through cooking, stir, turn vegetables over or rearrange. Stir after cooking. Allow to stand for 2 to 3 minutes before serving.

DRIED BEANS OR PEAS BY MICRO POWER

Place hot tap water in 4-litre dish. Bring hot water to the boil on 1000 W for 10 to 12 minutes. Add beans and 2 tablespoons oil to water. Cook according to directions in chart. Stir. Allow to stand, covered, for 15 to 20 minutes.

Note: Beans such as red kidney beans and lima beans should be soaked overnight before cooking. 250 g of dried beans equals about 3 cups cooked beans. Use in place of canned beans.

Cooking Frozen Vegetables by Micro Power

VEGETABLE	QUANTITY	COOKING PROCEDURE	APPROX. COOKING TIME (in minutes) on 1000 W
Beans	250 g	Cook in covered 2-litre dish.	4 to 6
Broad Beans	250 g	Cook in covered 2-litre dish.	5 to 7
Broccoli (spears)	350 g	Cook in covered 2-litre dish.	5 to 7
Brussels Sprouts	250 g	Cook in covered 2-litre dish.	5 to 7
Carrots (baby)	250 g	Cook in covered 2-litre dish.	6 to 8
Cauliflower	500 g	Cook in covered 2-litre dish.	6 to 8
Corn (½ cob)	125 g	Cook in covered 2-litre dish.	3 to 4
Corn (cobs)	250 g	Cook in covered 2-litre dish.	5 to 7
Mixed Vegetables	250 g	Cook in covered 2-litre dish.	5 to 7
Peas	250 g	Cook in covered 2-litre dish.	4 to 6
Spinach	250 g	Cook in covered 2-litre dish.	4 to 6

Cooking Dried Beans and Peas by Micro Power

ITEM	CONTAINER	AMOUNT OF HOT WATER	APPROX. TIME TO BOIL HOT WATER on 1000 W (in minutes) COVERED	TO COOK BEANS on 600 W (in minutes) COVERED
Lentils (200 g)	3.5-litre dish	1.5 litres	10 to 12	15 to 20
Soup Mix (200 g)	3.5-litre dish	1.5 litres	10 to 12	15 to 20
Split Peas or Lentils (200 g)	3.5-litre dish	1.5 litres	10 to 12	20 to 25
Beans (200 g) Soaked overnight	3.5-litre dish	1.5 litres	10 to 12	25 to 30

Vegetable Varieties (continued)

Cooking Fresh Vegetables by Micro Power

Vegetables should be covered and cooked on 1000 W for best results. Weights given are trimmed weights.

VEGETABLE	QUANTITY	COOKING PROCEDURE	APPROX. COOKING TIME (in minutes) on 1000 W
Asparagus	250 g	Covered dish with ¼ cup water	4 to 6
Beans (finely sliced)	250 g	Covered dish with ¼ cup water	4 to 5
Beetroot	4 whole (1 kg)	Covered with 1 cup water in 3.5-litre dish. Stand after cooking - 5 mins.	14 to 18
Broccoli	500 g	Covered dish with ¼ cup water.	6 to 8
Brussels Sprouts	250 g	Covered dish with ¼ cup water.	5 to 7
Cabbage	500 g	Shredded, with ¼ cup water in covered dish.	6 to 8
Carrots	4 (sliced finely) 250 g	With ¼ cup water in covered dish.	5 to 6
Cauliflower	500 g	With ¼ cup water in covered dish.	6 to 8
Celery	6 stalks (400 g) cut in 1 cm pieces	With ¼ cup water in covered dish.	5 to 7
Corn	2 cobs (500 g) 4 cobs (1 kg)	Brush with melted butter and cook in covered dish.	4 to 6 8 to 10
Eggplant	1 (500 g)	Dice with ¼ cup water in covered dish.	5 to 7
Mushrooms	250 g (sliced)	Cook with 2 tablespoons butter in covered dish.	3 to 4
Onions	3 (200 g)	Cut in quarters with ¼ cup water in covered dish.	4 to 6
Peas	250 g	Shell peas and place with ¼ cup water in covered dish.	3 to 5
Potatoes-Mashed -Jacket	500 g 3 Med	Peeled and quartered with ¼ cup water. Covered. Cook uncovered on paper towel lined plate.	6 to 8 7 to 9
Pumpkin	500 g	Peeled and cut into uniform pieces with ¼ cup water in covered dish.	8 to 10
Spinach/Silver Beef	250 g	Remove stem, cut leaves into small pieces. Cook with ¼ cup water in covered dish.	3 to 5
Sweet Potato	500 g	In serving size pieces with 2 tablespoons butter in covered dish.	6 to 8
Turnips	500 g	Peeled and sliced finely with ¼ cup water in covered dish.	6 to 8
Tomatoes	2 (300 g)	Sliced and cooked covered.	2 to 4
Zucchini	500 g	Cut in 2 cm pieces in covered dish.	5 to 7

Vegetable Varieties (continued)

CAULIFLOWER IN WHITE SAUCE

Serves: 4

Ingredients:

500 g	cauliflower flowerets
2 tablespoons	water
2 tablespoons	butter
2 tablespoons	flour
1 cup	milk
½ cup	grated tasty cheese

Method:

1. Place cauliflower and water in a shallow casserole dish. Cover and cook on 1000 W for 6-8 minutes.
2. Place butter in a 4 cup jug. Cook on 1000 W for 1-2 minutes, stir in flour and cook on 1000 W for 1 minute. Add milk gradually, stirring well and cook on 1000 W for 2-3 minutes. Stirring halfway through cooking.
3. Drain cauliflower, pour over sauce and sprinkle with cheese. Cook on 800 W for 2-3 minutes.

PARMESAN ASPARAGUS

Serves: 2 to 4

Ingredients:

1	bunch of asparagus spears
2 tablespoons	water
1 tablespoon	butter
1	clove garlic, crushed
1 tablespoon	grated Parmesan cheese

Method:

Place asparagus and water in a 2-litre casserole dish. Cover and cook on 1000 W for 1 to 2 minutes. Drain. Place butter and garlic in a small dish and cook on 1000 W for 1 minute. Add drained asparagus and mix lightly. Cook on 1000 W for a further 1 minute. Sprinkle Parmesan cheese over asparagus. Serve.

Tip:

When placing asparagus in dish, place half the tips one way and half the tips in the opposite direction for more even cooking.

ORIENTAL VEGETABLES

Serves: 4 to 6

Ingredients:

1 tablespoon	oil
1 cup	celery, sliced diagonally
1	large onion, cut into petals
1	green capsicum, cut into 2.5 cm pieces
1	red capsicum, cut into 2.5 cm pieces
1 cup	sliced mushrooms
1 tablespoon	Hoisin sauce
2 teaspoons	soy sauce

Method:

1. Place oil and vegetables in a 2-litre casserole dish. Stir well. Cook on 1000 W for 3 to 4 minutes, stirring halfway through cooking.
2. Mix sauces together in 1-cup glass jug and cook
3. on 1000 W for 1 minute. Pour over hot vegetables and mix well.

POTATO CASSEROLE

Serves: 4

Ingredients:

750 g	peeled and sliced potatoes
1 cup	sour cream
¼ cup	milk
3	green onions sliced
2	bacon rashers, chopped
½ cup	grated cheese

Method:

1. Layer potatoes in a 2-litre casserole dish. Pour over combined sour cream and milk. Cook on 1000 W for 15-18 minutes.
2. Top with spring onions, bacon and cheese. Cook on 1000 W for 5 minutes.

VEGETABLE CURRY

Serves: 4

Ingredients:

1	onion sliced
2 tablespoons	green curry paste
3 cups	sliced vegetables
1 can (440 g)	chick peas, drained
1 cup	coconut milk
1 tablespoon	lemon juice
1 tablespoon	soy sauce
½ cup	chopped nuts

Method:

1. Place onion and curry paste in a 3-litre casserole dish, cover with lid. Cook on 1000 W for 3-4 minutes.
2. Add remaining ingredients except nuts and stir. Cook on 1000 W for 12-14 minutes. Stirring halfway through cooking. Sprinkle with chopped nuts and serve.

Vegetable Varieties (continued)

STUFFED TOMATOES

Serves: 2

Ingredients:

2 (large)	tomatoes
¼ cup	fresh breadcrumbs
½ cup	grated cheese
4	green onions, finely sliced
1 tablespoon	finely chopped parsley
	salt and pepper
¼ cup	extra grated cheese

Method:

1. Cut tops off tomatoes. Scoop out pulp of tomato with a teaspoon. Mix pulp with remaining ingredients, except extra cheese.
2. Spoon mixture back into tomato shells. Sprinkle tomatoes with extra cheese.
3. Place tomatoes in 2-litre casserole dish and cook on 1000 W for 2 to 3 minutes. Serve.

Tip: To cook 4 stuffed tomatoes, cook on 1000 W for 6 to 8 minutes.

VEGETABLE FRITTATA

Serves: 4 to 6

Ingredients:

400 g	potatoes, thinly sliced
½	red capsicum, sliced into strips
½	green capsicum, sliced into strips
1	tomato, diced
2 tablespoons	fresh basil, chopped
4	eggs
⅓ cup	sour cream
½ teaspoon	cracked black pepper
½ cup	grated tasty cheese

Method:

Place potatoes in a 2.5-litre shallow dish. Cook on 1000 W for 5 to 7 minutes. Arrange capsicum in a circular pattern on top of potato sprinkle with tomato and basil. Beat together eggs and sour cream in a jug. Pour over vegetables. Cook on 800 W for 3 to 5 minutes. Sprinkle with pepper and cheese and cook on 1000 W for 7 to 9 minutes.

CREAMED SPINACH

Serves: 4

Ingredients:

1	bunch spinach, roughly chopped
4	green onions, finely chopped
1	clove garlic, crushed
2 tablespoons	sour cream
	salt and pepper

Method:

Cook washed spinach leaves, green onions and garlic in a covered 3-litre casserole dish on 1000 W for 5 to 7 minutes. Drain well by squeezing between two dinner plates. Stir through sour cream. Season to taste. Cook on 1000 W for 1 to 2 minutes. Serve.

ARDENNIS STYLE POTATOES

Serves: 4

Ingredients:

4	medium sized potatoes
100 g	ham, finely diced
3 tablespoons	snipped chives
50 g	butter
½ cup	grated Cheddar cheese
	ground black pepper

Method:

Scrub potatoes, wash and pat dry with paper towel. Prick skins and place on a dinner plate. Cook on 1000 W for 6 to 8 minutes.

Allow to cool slightly. Cut tops off potatoes and scoop out pulp from centre, leaving 1 to 2 cm in shell. Mash pulp and combine with remaining ingredients. Spoon filling back into potato shells. Place potatoes in 2-litre casserole dish. Cook on 1000 W for 2 to 3 minutes.

Rice, Pasta and Cereal

Cooking Rice and Other Grains by Micro Power

Follow directions in chart for recommended dish size, amounts of water and cooking time. Add grain to water. Add salt and butter according to package directions. Cook on 1000 W for time recommended

in chart. Allow to stand, covered, before serving. For special rice, substitute beef or chicken stock for water. Add cooked onion, mushrooms or crumbled bacon before serving.

ITEM	CONTAINER	AMOUNT OF WATER	APPROX. TIME TO COOK GRAIN on 1000 W UNCOVERED (in minutes)	STANDING TIME (in minutes)
RICE Quick Cook Brown (1 cup)	2-litre dish	1 $\frac{1}{3}$ cups	10	5
Brown (1 cup)	3-litre dish	3 cups	25 to 30	10
Long Grain (1 cup)	2-litre dish	2 cups	12 to 14	5
Short Grain (1 cup)	2-litre dish	2 cups	12 to 14	5
Jasmine (1 cup)	3-litre dish	2 cups	12 to 14	5

Cooking Pasta by Micro Power

Follow directions in chart for recommended dish size, amount of water and cooking time. Boil water, with 1 teaspoon salt and 1 tablespoon oil. Add pasta and cook for time recommended in chart. Cook on 1000 W.

Test pasta for desired cooking before adding more time. Slightly undercook pasta that will be heated again in casserole. Stir and let stand, uncovered, 5 minutes.

ITEM	CONTAINER	AMOUNT OF BOILING WATER	APPROX. TIME TO COOK PASTA on 1000 W UNCOVERED (in minutes)	STANDING TIME (in minutes)
Dried Fettuccine (250 g)	3.5-litre dish	6 cups	12 to 14	5
Elbow Macaroni, shells, etc. (250 g)	3-litre dish	4 cups	14 to 16	5
Fresh Spaghetti, Fettuccine (375 g)	3.5-litre dish	6 cups	12 to 14	5
Dried Spaghetti (250 g)	3.5-litre dish	4 cups	12 to 14	5
Fresh Tortellini, Ravioli (250 g)	3.5-litre dish	4 cups	10 to 12	5

Drain pasta after standing.

Cooking Hot Cereal by Micro Power

Combine $\frac{1}{4}$ cup of quick cooking oats, pinch salt and $\frac{2}{3}$ cups hot tap water in a breakfast bowl.



Cook on 1000 W for 2 to 3 minutes, stirring halfway through cooking.



Let stand, 5 to 10 minutes, before serving. Top as desired with sugar or spices.

Rice, Pasta and Cereal (continued)

BACON AND ONION TORTELLINI

Serves: 4

Ingredients:

600 g fresh tortellini
6 cups boiling water
1 onion, diced
1 clove garlic, crushed
3 rashers bacon, chopped
300 ml cream
1 tablespoon parmesan cheese
1 teaspoon chicken stock powder
2 tablespoons chopped parsley
ground black pepper
Parmesan cheese, extra

Method:

1. Place pasta and water in a 3-litre casserole dish. Cook on 1000 W for 10-14 minutes. Stand covered for 2 minutes. Drain.
2. Place onion, garlic and bacon in a 2-litre casserole dish and cook on 1000 W for 5 minutes. Add cream, cheese, stock powder and parsley stir until combined.
3. Add pasta and cook on 1000 W for 2-3 minutes. Serve sprinkled with pepper and extra parmesan cheese.

PESTO FETTUCCINE

Serves: 4

Ingredients:

250 g dried fettuccine
6 cups boiling water
2 cloves garlic, crushed
1 cup basil leaves
1 tablespoon pinenuts
½ cup parmesan cheese
1 cup olive oil

Method:

1. Place pasta and water in a 3-litre casserole dish. Cook on 1000 W for 14-16 minutes. Allow to stand for 5 minutes then drain.
2. Place remaining ingredients except oil in a food processor. Slowly add oil in a fine stream while processing.
3. Stir sauce through pasta and serve.

CREAMY BACON SAUCE

Makes: Approximately 300 ml

Ingredients:

1 onion, chopped
3 bacon rashers, chopped
1 teaspoon minced garlic
300 ml cream
¼ cup Parmesan cheese
pepper
2 tablespoons chopped fresh parsley

Method:

Place onion, bacon and garlic in a 2-litre casserole dish. Cook on 1000 W for 4 to 5 minutes. Add cream, Parmesan cheese, pepper, parsley and stock. Mix well. Cook on 1000 W for 3 to 4 minutes. Serve with cooked Fettuccine.

MACARONI AND CHEESE

Serves: 4 to 6

Ingredients:

40g butter
1 onion, finely chopped
2 tablespoons flour
2 cups milk
1 cup grated tasty cheese
6 cups cooked macaroni, drained well
½ cup extra grated tasty cheese
paprika

Method:

Place butter and onion in a 2-litre casserole dish and cook on 1000 W for 3 to 5 minutes. Add flour, mix well and cook on 1000 W for 1 minute. Blend in milk and cook on 1000 W for 4 to 5 minutes, stirring halfway through cooking. Add cheese to sauce and season. Place macaroni and sauce in a 3-litre casserole dish. Mix well.

1. Top with extra cheese and sprinkle with paprika. Cook on 1000 W for 6 to 8 minutes.

STIR FRIED RICE

Serves: 4

Ingredients:

1 tablespoon vegetable oil
1 clove garlic, crushed
1 teaspoon ginger
1 small carrot, finely chopped
1 stick celery, sliced
½ red capsicum, diced
6 to 8 medium mushrooms, sliced
2 eggs
4 green onions, chopped
black pepper
1 small can prawns (optional)
1-2 tablespoons soy sauce
2 cups cooked rice

Method:

1. Place oil, garlic and ginger in large shallow dish and cook on 1000 W for 1 to 2 minutes. Add carrot, celery and capsicum. Cook a further 2-3 minutes on 1000 W.
2. Break eggs into small dish, add pepper to taste, mix well and cook on 600 W for 2 to 3 minutes. Slice into thin strips.
3. Add eggs plus all remaining ingredients to vegetable mixture. Stir well and cook on 1000 W for 3 to 5 minutes to heat thoroughly. Serve.

Desserts

BUTTERSCOTCH PUDDING

Serves: 4 to 6

Ingredients:

400 g	sweetened condensed milk
30 g	butter
1 teaspoon	vanilla essence
½ cup	milk
¾ cup	self raising flour, sifted
1 cup	brown sugar
½ cup	hot tap water

Method:

1. Place condensed milk in 2-litre casserole dish. Cook on 600 W for 6 to 7 minutes, stirring twice during cooking.
2. Stir in butter, vanilla essence and milk. Stir until butter is melted. Cool slightly.
3. Add milk mixture to sifted flour. Mix well. Pour mixture into 2-litre casserole dish.
4. Sprinkle top with brown sugar and gently pour hot tap water over mixture. Cook on 1000 W for 6 to 8 minutes.

APRICOT AND RASPBERRY CRISP

Serves: 4 to 6

Ingredients:

850 g	can apricots, drained
400 g	frozen raspberries
1 cup	plain flour
½ cup	brown sugar
1 teaspoon	cinnamon
1 cup	pecans, chopped
1 cup	shredded coconut
2 cups	toasted muesli
125 g	butter

Method:

1. Place apricots and raspberries in the base of 2-litre casserole dish. Place remaining ingredients (except butter) in a mixing bowl.
2. Melt butter in 2-cup jug on 1000 W for 40 to 50 seconds. Combine melted butter with dry ingredients and mix well.
3. Crumble mixture over top of fruit. Cook on 1000 W for 10 to 12 minutes.

PEAR CUSTARD

Serves: 6

Ingredients:

825 g	pear halves, drained
2 tablespoons	plain flour
⅓ cup	caster sugar
3	eggs
1 teaspoon	vanilla essence
1 cup	milk
1 teaspoon	cinnamon

Method:

1. Grease 20 cm square pyrex dish. Place pear halves in dish. Set aside. Place flour, sugar, eggs and vanilla essence in bowl. Whisk until combined.
2. Whisk in milk and pour mixture over pears. Sprinkle with cinnamon. Cover dish with plastic wrap and cook on 1000 W for 8 to 10 minutes.

FIGS IN RIESLING AND HONEY

Serves 4

Ingredients:

8	firm figs
1½	cups Riesling wine
80 ml	honey
1 teaspoon	lemon juice
1 teaspoon	grated lemon rind
2 tablespoons	chopped pistachio nuts

Method:

Wash and stem the figs place into a 2 litre dish. Combine Riesling, and honey and pour over figs. Cook on 600 W for 6 to 8 minutes. Remove figs from syrup, set aside. Add lemon juice and rind to syrup and cook on 1000 W for 3 to 4 minutes or until slightly reduced. Pour syrup over figs and allow to cool. Serve with ice cream or cream and sprinkle with pistachio nuts.

CHOCOLATE BROWNIES

Makes: 1 x 20 cm square slice pan

Ingredients:

125 g	butter
200 g	chocolate
1 cup	caster sugar
1 teaspoon	vanilla essence
2	eggs
1 cup	plain flour

Method:

1. Grease and line 20 cm square pyrex dish. Set aside. Melt butter and chocolate in 2-litre dish on 1000 W for 2 minutes.
2. Stir in sugar, vanilla essence, eggs and flour. Spread into prepared dish.
3. Cook on 600 W for 8 to 10 minutes. Refrigerate until cold. Cut into squares.

Before Requesting Service

ALL THESE THINGS ARE NORMAL

The oven causes interference with my TV.	Some radio, TV, Wi-Fi, cordless telephone, baby monitor, blue tooth or other wireless equipment interference might occur when you cook with the microwave oven. This interference is similar to the interference caused by small appliances such as mixers, vacuums, hair dryers, etc. It does not indicate a problem with your oven.
The oven lights dim.	When cooking with a power other than 1000 W, the oven must cycle to obtain the 100 W levels. The oven light will dim and clicking noises can be heard when the oven cycles.
Steam accumulates on the oven door and warm air comes from the oven vents.	During cooking, steam and warm air are given off from the food. Most of the steam and warm air are removed from the oven by the air which circulates in the oven cavity. However, some steam will condense on cooler surfaces such as the oven door. This is normal.
I accidentally ran my microwave oven without any food in it.	Running the oven empty for a short time will not damage the oven. However, we do not recommend this.

PROBLEM	POSSIBLE CAUSE	REMEDY
Oven will not turn on.	The oven is not plugged in securely.	Remove plug from outlet, wait 10 seconds and re-insert.
	Circuit breaker or fuse is tripped or blown.	Contact the specified service center.
	There is a problem with the outlet.	Plug another appliance into the outlet to check if the outlet is working.
Oven will not start cooking.	The door is not closed completely.	Close the oven door securely.
	Start Button was not pressed after programming.	Press Start Button.
	Another program has already been entered into the oven.	Press Stop/Reset Button to cancel the previous program and program again.
	The program has not been entered correctly.	Program again according to the Operating Instructions.
When the oven is turning on, there is noise coming from Glass Tray.	Stop/Reset Button has been pressed accidentally.	Program oven again.
	The roller ring and oven bottom are dirty.	Clean these parts according to care of your oven (See next page).
The "🔑" appears in the display window.	The Child Safety Lock was activated by pressing Start Button 3 times.	Deactivate Lock by pressing Stop/Reset Button 3 times.
"H00", "H97" or "H98" appears in the display window.	The display indicates a problem with microwave generation system.	Contact the specified service centre.

If it seems there is a problem with the oven, contact an authorized Service Center.

Care of your Microwave Oven

Turn the oven off and remove the power plug from the wall socket before cleaning.

Keep the inside of the oven clean. When food splatters or spilled liquids adhere to oven walls, wipe with a damp cloth. Mild detergent may be used if the oven gets very dirty. The use of harsh detergent or abrasives is not recommended.

It is occasionally necessary to remove the glass tray for cleaning. Wash the tray in warm sudsy water or in a dishwasher.

The outside oven surfaces should be cleaned with a damp cloth. To prevent damage to the operating parts inside the oven, water should not be allowed to seep into the ventilation openings.

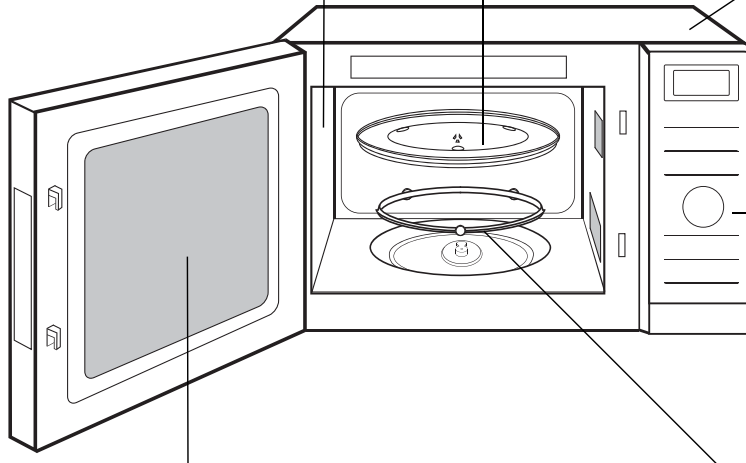

Do not allow the Control Panel to become wet. Clean with a soft, damp cloth. Do not use detergents, abrasives or spray-on cleaners on the Control Panel. When cleaning the Control Panel, leave oven door open to prevent oven from accidentally turning on. After cleaning press **Stop/Reset** Button to clear display window.

If steam accumulates inside or around the outside of the oven door, wipe with a soft cloth. This may occur when the microwave oven is operated under high humidity conditions and in no way indicates malfunction of the unit.

The roller ring and oven cavity floor should be cleaned regularly to avoid excessive noise. Simply wipe the bottom surface of the oven with mild detergent, water or window cleaner and dry. The roller ring may be washed in mild sudsy water or dish washer. Cooking vapors collect during repeated use but in no way affect the bottom surface or roller ring wheels. When removing the roller ring from cavity floor for cleaning, be sure to replace in the proper position.

Note

1. When it becomes necessary to replace the oven light, please consult a dealer to have it replaced.
2. The oven should be cleaned regularly and any food deposits removed.
3. Do not use harsh abrasive cleaners or sharp metal scrapers to clean the oven door glass, since they can scratch the surface, which may result in shattering of the glass.

Technical Specifications

Model	NN-SD38HS
Power Supply:	230 - 240 V, 50 Hz
Power Consumption:	4.9 A 1,150 W
Operating Frequency:	2,450 MHz
Output*:	1000 W
Outside Dimensions (W x H x D):	488 mm (W) x 279 mm (H) x 395 mm (D)
Oven Cavity Dimensions (W x H x D):	315 mm (W) x 206 mm (H) x 353 mm (D)
Overall Cavity Volume:	23 L
Glass Tray Diameter:	Ø285 mm
Uncrated Weight:	Approx. 9.5 kg

* IEC Test Procedure

Specifications subject to change without notice.

As for the voltage requirement, the production month, country and serial number, please refer to the identification plate on the microwave oven.

Panasonic Warranty (for Australia)

Home Appliance 12 Month Warranty from Date of Purchase

1. Subject to the conditions of this warranty Panasonic or its Authorised Service Centre will perform necessary service on the product without charge for parts or labour, if in the opinion of Panasonic, the product is found to be faulty within the warranty period. For Communications products (i.e. Cordless Phones, etc) the genuine battery(s) has a 3 month warranty.
2. This warranty only applies to Panasonic products purchased in Australia and sold by Panasonic Australia or its Authorised Distributors or Dealers and only where the products are used and serviced within Australia or its territories. Warranty cover only applies to service carried out by a Panasonic Authorised Service Centre and only if valid proof of purchase is presented when warranty service is requested.
3. This warranty only applies if the product has been installed and used in accordance with the manufacturer's recommendations (as noted in the operating instructions) under normal use and reasonable care (in the opinion of Panasonic). The warranty covers normal domestic use only (also Clip & Trim Professional use) and does not cover damage, malfunction or failure resulting from use of incorrect voltages, incorrect installation, accident, misuse, neglect, build-up of dirt or dust, abuse, maladjustment of customer controls, mains supply problems, thunderstorm activity, infestation by insects or vermin, tampering or repair by unauthorised persons (including unauthorised alterations), exposure to abnormally corrosive conditions or any foreign object or matter having entered the product.
4. This warranty does not cover the following items unless the fault or defect existed at the time of purchase:
 - (a) Cabinet Parts
 - (b) Microwave Oven Plates.
 - (c) User replaceable Batteries
 - (d) Kneader Mounting Shaft, Shaver Heads, Cutters, Foils, Blades
 - (e) Accessories
 - (f) Noise or vibration that is considered normal
5. To claim warranty service, when required, you should:
 - Contact Panasonic's Customer Care Centre on 132600
 - Send or take the product to a Panasonic Authorised Service Centre together with your purchase receipt as a proof of purchase date. Please note that freight and insurance to and / or from your nearest Authorised Service Centre must be arranged by you.
6. The warranties hereby conferred do not extend to, and exclude, any costs associated with the installation, de-installation or re-installation of a product, including costs related to the mounting, de-mounting or remounting of any screen, (and any other ancillary activities), delivery, handling, freighting, transportation or insurance of the product or any part thereof or replacement of and do not extend to, and exclude, any damage or loss occurring by reason of, during, associated with, or related to such installation, de-installation, re-installation or transit.

Panasonic Authorised Service Centres are located in major metropolitan areas and most regional centres of Australia, however, coverage will vary dependant on product. For advice on exact Authorised Service Centre locations for your product, please telephone our Customer Care Centre on 132600.

In addition to your rights under this warranty, Panasonic products come with consumer guarantees that cannot be excluded under the Australian Consumer Law. If there is a major failure with the product, you can reject the product and elect to have a refund or to have the product replaced or if you wish you may elect to keep the goods and be compensated for the drop in value of the goods. You are also entitled to have the product repaired or replaced if the product fails to be of acceptable quality and the failure does not amount to a major failure.

If there is a major failure in regard to the product which cannot be remedied then you must notify us within a reasonable period by contacting the Panasonic Customer Care Centre. If the failure in the product is not a major failure then Panasonic may choose to repair or replace the product and will do so in a reasonable period of time from receiving notice from you.

THIS WARRANTY CARD AND THE PURCHASE DOCKET (OR SIMILAR PROOF OF PURCHASE) SHOULD BE RETAINED BY THE CUSTOMER AT ALL TIMES

If you require assistance regarding warranty conditions or any other enquiries, please visit the **Panasonic Australia** website www.panasonic.com.au or contact by phone on **132 600**
If phoning in, please ensure you have your operating instructions available.

Panasonic Australia Pty. Limited

ACN 001 592 187 ABN 83 001 592 187

1 Innovation Road, Macquarie Park NSW 2113
www.panasonic.com.au

PRO-031-F01 Issue: 6.0

02-10-2013

Panasonic Warranty (for New Zealand)

Home Appliance 12 Month Warranty from Date of Purchase

1. Subject to the conditions of this warranty Panasonic or its Authorised Service Centre will perform necessary service on the product without charge for parts or labour, if in the opinion of Panasonic, the product is found to be faulty within the warranty period. For Line Communications products (i.e. Cordless Phones, etc) the genuine battery(s) has a 3 month warranty.
2. This warranty only applies to Panasonic products purchased in New Zealand and sold by Panasonic New Zealand or its Authorised Distributors or Dealers and only where the products are used and serviced within New Zealand or its territories. Warranty cover only applies to service carried out by a Panasonic Authorised Service Centre and only if valid proof of purchase is presented when warranty service is requested.
3. This warranty only applies if the product has been installed and used in accordance with the manufacturer's recommendations (as noted in the operating instructions) under normal use and reasonable care (in the opinion of Panasonic). The warranty covers normal domestic use only (also Clip & Trim Professional use) and does not cover damage, malfunction or failure resulting from use of incorrect voltages, incorrect installation, accident, misuse, neglect, build-up of dirt or dust, abuse, maladjustment of customer controls, mains supply problems, thunderstorm activity, infestation by insects or vermin, tampering or repair by unauthorised persons (including unauthorised alterations), exposure to abnormally corrosive conditions or any foreign object or matter having entered the product.
4. This warranty does not cover the following items unless the fault or defect existed at the time of purchase:
 - (a) Cabinet Parts
 - (b) Microwave Oven cook plates.
 - (c) User replaceable Batteries from wear and tear in normal use
 - (d) Kneader mounting shaft unit and Heads, Cutters, Foils, Blades and other accessories.
 - (e) Noise or vibration that is considered normal
5. To claim warranty service, when required, you should:
 - Telephone Panasonic's Customer Care Centre on 09 2720178 or visit our website referred to below and use the Service Centre Locator for the name/address of the nearest Authorised Service Centre.
 - Send or take the product to a Panasonic Authorised Service Centre together with your proof of purchase receipt as a proof of purchase date. Please note that freight and insurance to and / or from your nearest Authorised Service Centre must be arranged by you.
6. The warranties hereby conferred do not extend to, and exclude, any costs associated with the installation, de-installation or re-installation of a product, including costs related to the mounting, de-mounting or remounting of any screen, (and any other ancillary activities), delivery, handling, freighting, transportation or insurance of the product or any part thereof or replacement of and do not extend to, and exclude, any damage or loss occurring by reason of, during, associated with, or related to such installation, de-installation, re-installation or transit.

Panasonic Authorised Service Centres are located in major metropolitan areas and most regional centres of New Zealand, however, coverage will vary dependant on product. For advice on exact Authorised Service Centre locations for your product, please telephone our Customer Care Centre on 09 2720178 or visit our website and use the Service Centre Locator.

Unless otherwise specified to the consumer the benefits conferred by this express warranty are additional to all other conditions, warranties, guarantees, rights and remedies expressed or implied by the Consumer Guarantees Act of New Zealand and all other obligations and liabilities on the part of the manufacturer or supplier and nothing contained herein shall restrict or modify such rights, remedies, obligations and liabilities.

THIS WARRANTY CARD AND THE PURCHASE DOCKET (OR SIMILAR PROOF OF PURCHASE) SHOULD BE RETAINED BY THE CUSTOMER AT ALL TIMES

If you require assistance regarding warranty conditions or any other enquiries, please visit the **Panasonic New Zealand** website www.panasonic.co.nz or contact by phone on **09 2720178**
If phoning in, please ensure you have your operating instructions available.

Panasonic New Zealand Customer Care Centre

Phone: 09 2720178

Fax: 09 2720129

Email: customerservice@nz.panasonic.com

Website: www.panasonic.co.nz/support

© Panasonic Appliances Microwave Oven (Shanghai) Co., Ltd. 2017

F0003BW40QP
PA0817-0
Printed in China