

**aceline**



Aceline AMC553L



!

•

•

•

•

•

•

•

•

•

•

•

•



•

•

•

•

•

: AMC553L.

•

: Aceline.

•

: 550 .

•

: 220–240 , 50 .

•

: 3 .

•

: 10.

•

: IPX0.

•

: I.

•

: X.

•

: 24,3 × 25,5 × 25 .

•

: 2,6 .

•

:

•

•

•

•

•

•

•

•

•

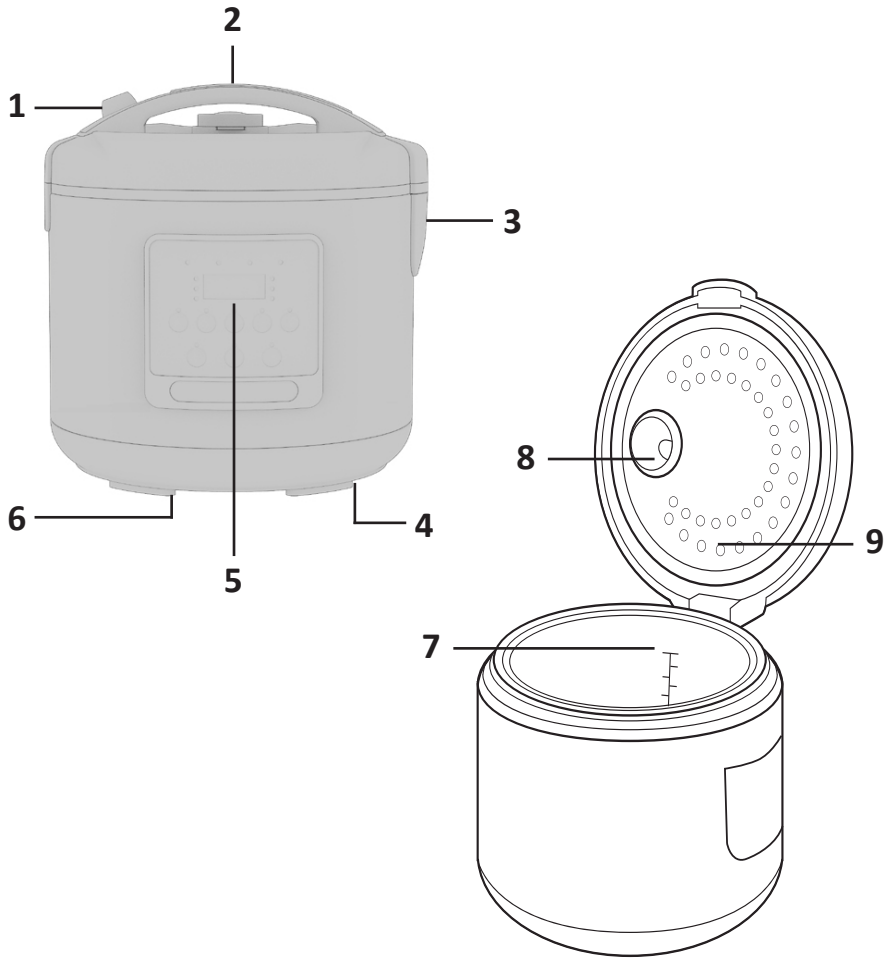

- 1.
- 2.
- 3.
- 4.
- 5.
- 6.
- 7.
- 8.
- 9.

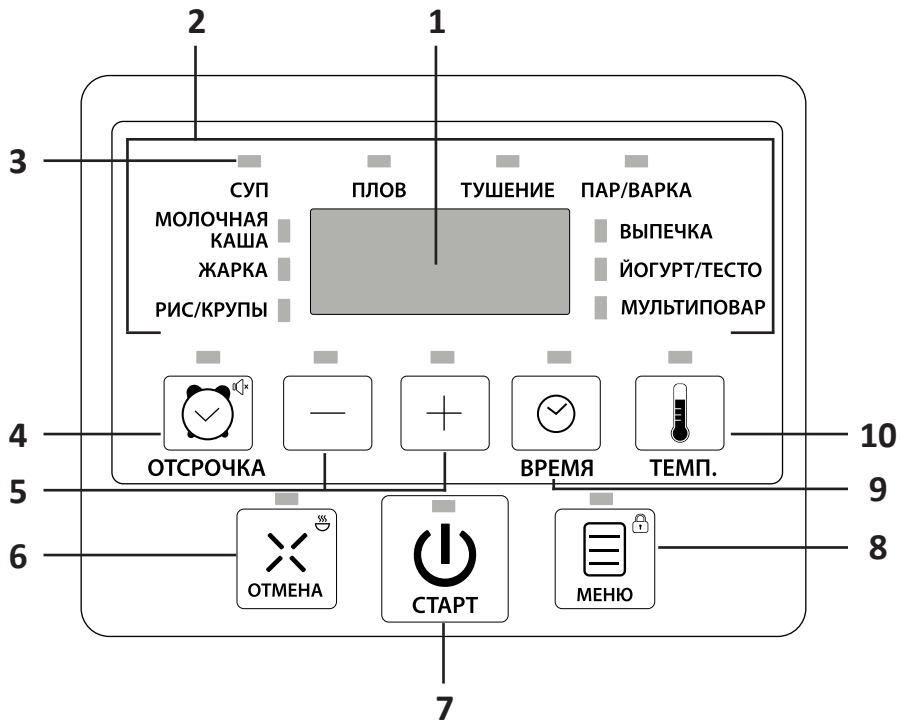

1. .
2. .
3. .
4. " " —
5. " — " + " — / / .
6. " " — / / ,
7. " " —
8. " " — ,
9. " " —
10. " " —

- - 
  -
- 1.
  - 2.
  - 3.
  4. "MENU"
  5. "START". "START"
  6. "End",
  - 7.
- „TIME“ 3
- „MENU“
- 3
- "CANCEL".

„MENU“ 3 „TIME“ 3

"CANCEL".

"START".

1.

2.

"TEMP."

3.

"+" "-"

4.

"START".

1.

2.

"TIME".

3.

"+" "-"

"TIME".

4.

1.

|     |                 |                                 |   |    |    |
|-----|-----------------|---------------------------------|---|----|----|
|     |                 |                                 |   |    |    |
|     | 1:00            | 1 - 8 .                         | - | 24 | 12 |
|     | 0:30            | 1 - 4 .                         | - | 24 | 12 |
|     | 1:10            | 1 - 2 .                         | - | 24 | 12 |
|     | 1:00            | 1 - 12 .                        | - | 24 | 12 |
| /   | 00:40           | 1 - 2 .                         | + | 24 | 12 |
|     | 01:00           | 1 - 4 .                         | - | 24 | 4  |
|     | 00:20           | 1 - 2 .                         | + | -  | -  |
| /   | 08:00           | 10 - 12 .                       | - | 24 | -  |
| / - |                 |                                 | - | 24 | -  |
|     | 00:30<br>100 °C | 1 - 15<br>. 1 - 2<br>35-160 °C* |   | 24 | 12 |

\*MULTICOOK

2 .

130°C-

- 
- 
- 

!

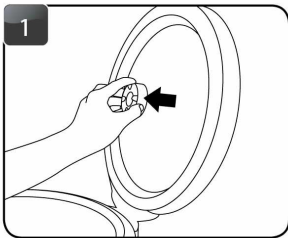

1.

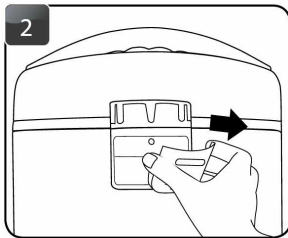

2.

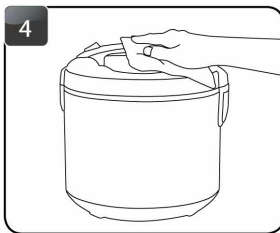
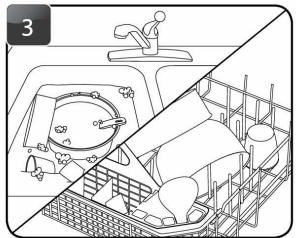

4.

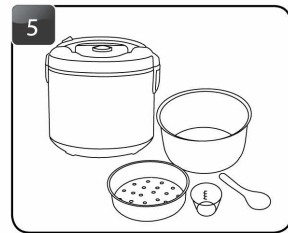

5.

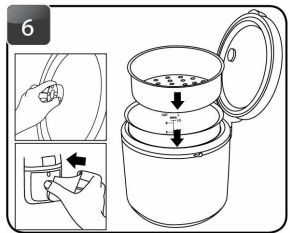

6.

|         |       |           |
|---------|-------|-----------|
|         |       |           |
| : E1-E4 |       |           |
|         | /     |           |
|         |       |           |
|         |       |           |
|         | ( )   |           |
|         | ( , ) |           |
|         |       |           |
|         |       |           |
| ( )     |       |           |
|         |       | ( , , , ) |
|         |       |           |

•  
•  
80%- ( 5°C- 40°C- )  
( )

- 
- 
- 
-

**Manufacturer:** Guangzhou STENT industrial.  
No.2, No.4 Workshop, No.11-1-4, Fuan Industrial Zone, Chonghe Village Committee,  
Leliu Street, Shunde District, Foshan City, Guangdong Province, P.R. China.

: Guangzhou STENT Industrial.

№2, №4, №11-1-4,  
, , , , ,  
, .  
:  
:  
/ 405791674 ,  
,  
, N 47, 1, 1-2

info@dns-shop.ge

TP TC (EAЭC)

:



: \_\_\_\_\_

v.6

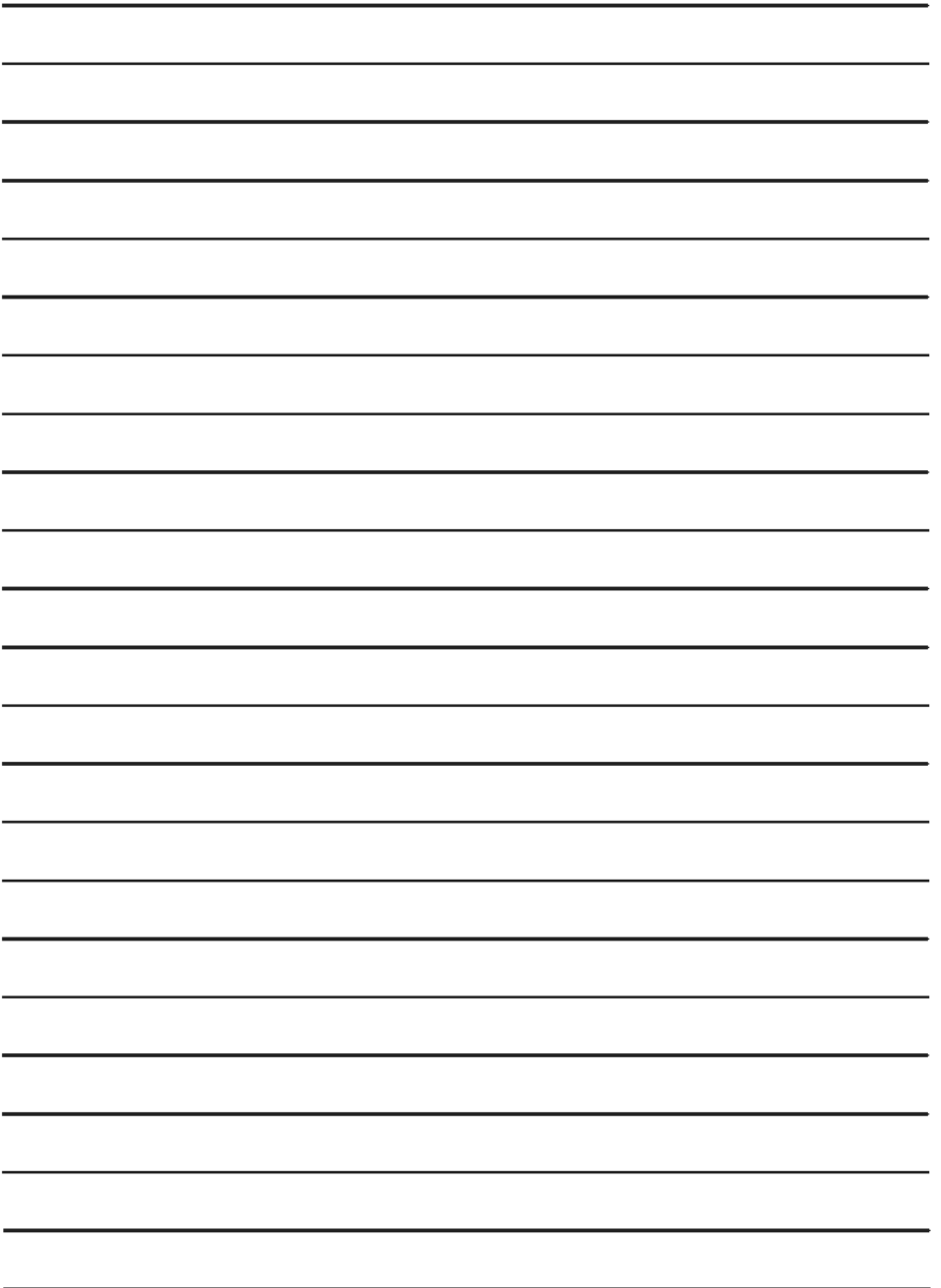

SN/IMEI:

\_\_\_\_\_

\_\_\_\_\_

:

:24

:36

:

( ).

, HANDS-FREE

;

(

),

/



• :  
• )  
• /  
• -  
• ( )  
• )  
• ( )  
• ( ; ) ( )  
• /  
• )  
• ( ) ( ) /  
• ) ( CD, DVD, , SIM  
• ) ( , Java )



**aceline**