

D-1600

DEXP

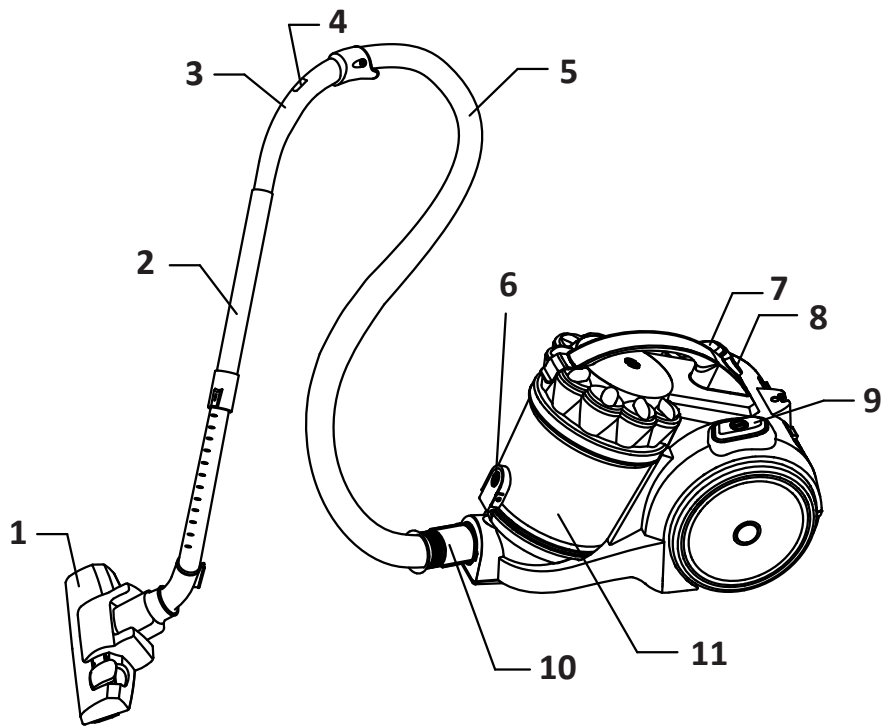

1. 2 1-

2.

3.

4.

5.

6.

7.

8.

9.

10.

11.

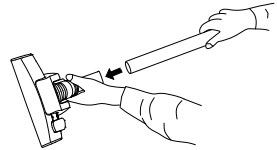
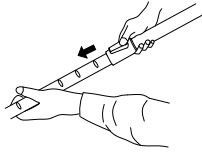
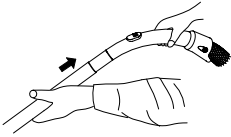
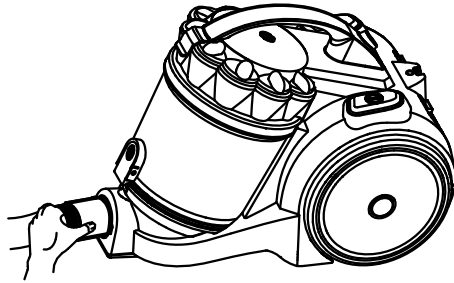

1.

2.

3.

4.

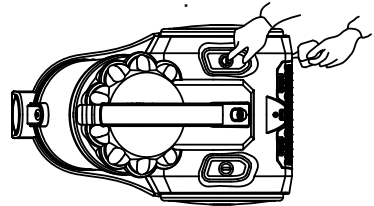
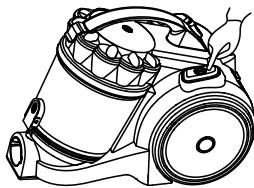
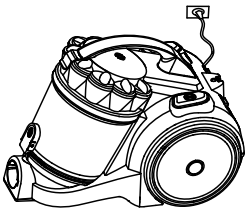

2 1-

/

-
-

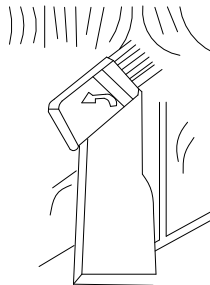
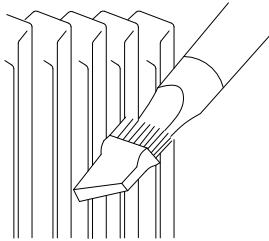
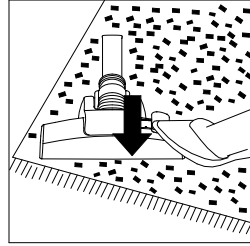
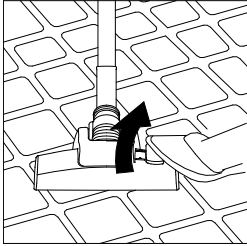

-
-
-

1.

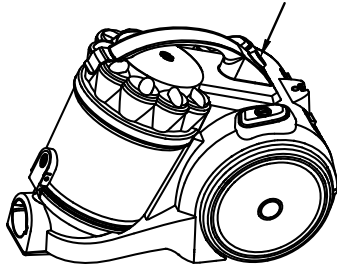

2.

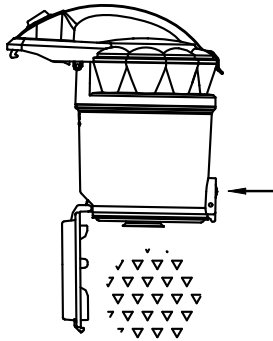

3.

;

1.

2.

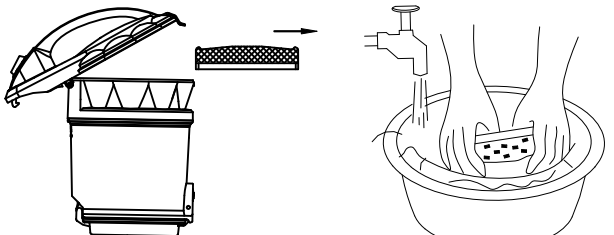

	' : ' .
	' „On“ .
	" " .
	.
.	'

- : D-1600
 - : DEXP
 - : 80 dB
 - : 220–240 V ~ 50/60 Hz
 - : 1600 W
 - : 300 W
 - : 3
 - :
 - :
 - : II
 - : IP20
 - : Y
 - : 4.5
 - (× ×): 285 × 333 ×
- 445

- : 5.4
- :

-
-
-
- 2-1-
-
-
-

, , (,)
 •
 •
 °C- 40 °C- , , , 5
 (, 80%-),
 •
 • — ,
 • , , ,
 •
 •
 •

No2008,

Manufacturer: Ningbo Dahua Electric Appliance Co., Ltd.
 No.2008 Shinan West Road, Xiaodong Industrial Zone, Yuyao City, Ningbo City,
 Zhejiang Province, P.R.China.

: / 405791674

, N 47,

1, 1-2

info@dns-shop.ge

(EAEC)



: _____ V.1

SN/IMEI: _____



