

**aceline**

---

Aceline  
AMC553, AMC865







	AMC553	AMC865
	Aceline	
( )	550	860
( , )	220–240 , 50	
( )	3	5
10		
	I	
	X	

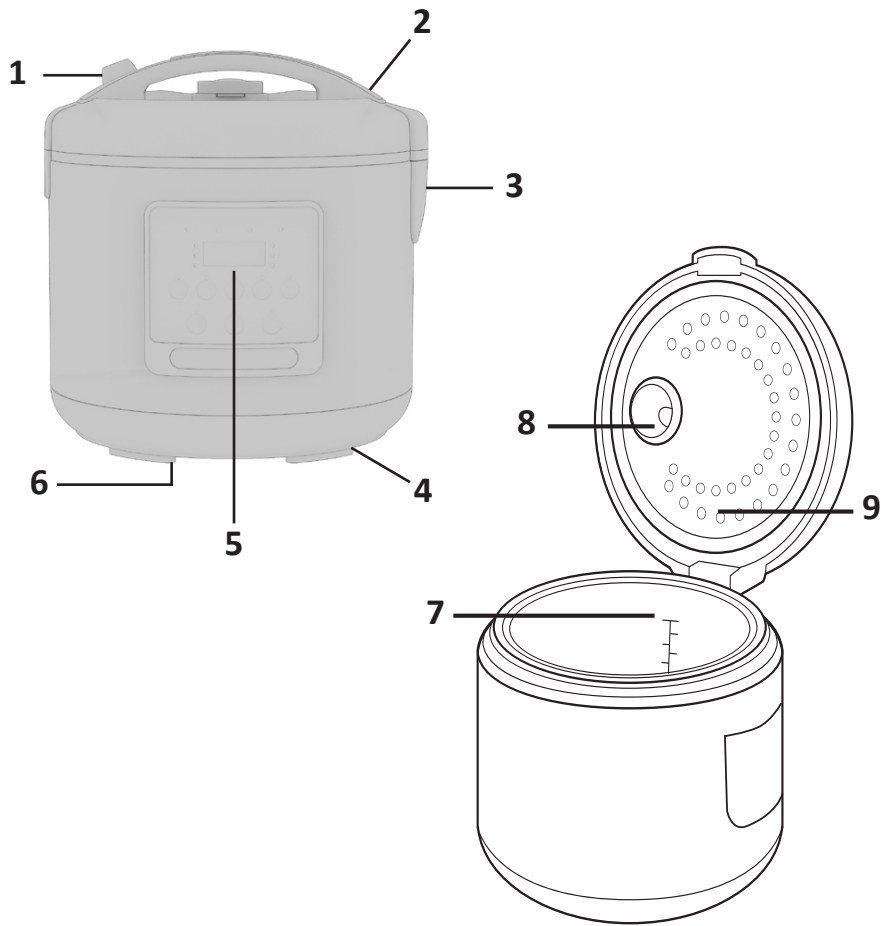

- 1.
- 2.
- 3.
- 4.
- 5.
- 6.
- 7.
- 8.
- 9.



1. .
2. .
3. .
4. " " —
5. " — " + " —
6. " " — / /
7. " " —
8. " " — ,
9. " " —
10. " " —

```

•
•
    .
    ,
    (
    "
    ").
    ,
    ,
    ,
    ,
    ,
    .
1.
    ,
    ,
    ,
    .
2.
    ,
    .
3.
    .
4.
    "MENU"
5.
    ,
6.
    "START".
    ,
    "Start"
    .
7.
    "End"
    ,
    .
    ,
    .
    8.
    ,
    "
    "
    .

```

„TIME“ 3

„MENU“ 3

"CANCEL".

"START".

- 1.
2. „TEMP.“
3. "+ " "-
4. "START".

- 1.
2. „TIME“.
3. "+ " "-
4. "TIME".

- 1.
2. "+ " "-

	1:00	1 - 8 .	-	24	12
	0:30	1 - 4 .	-	24	12
	1:10	1 - 2 .	-	24	12
	1:00	1 - 12 .	-	24	12
/	00:40	1 - 2 .	+	24	12
	01:00	1 - 4 .	-	24	4
	00:20	1 - 2 .	+	-	-
/	08:00	10 - 12 .	-	24	-
/ -			-	24	-
	00:30 100 °C	1 - 15 . 1 - 2 35-160 °C*		24	12

\*MULTICOOK

2

130°C-

- 
- 
- 

!

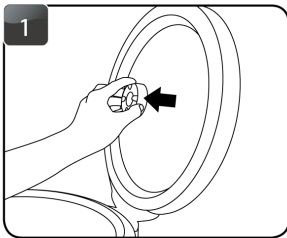

1.

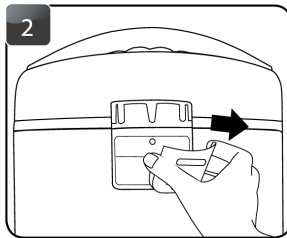

2.

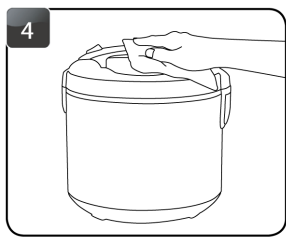
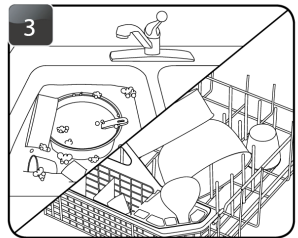

4.

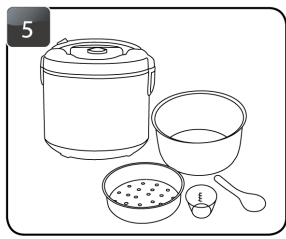

5.

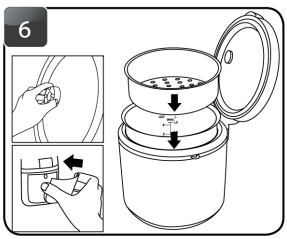

6.

: E1-E4	,	.
	/	.
	( )	,
	( , )	.
		,
		.
( )		,
		( , , , )
		.

•  
•  
80%- ( 5°C- 40°C- )  
( )

- 
- 
- 
-

**Manufacturer:** Guangzhou STENT industrial.  
No.2, No.4 Workshop, No.11-1-4, Fuan Industrial Zone, Chonghe Village Committee,  
Leliu Street, Shunde District, Foshan City, Guangdong Province, P.R. China.

: Guangzhou STENT Industrial.

№2, №4, №11-1-4,  
,  
,  
,  
:  
:  
/ 405791674,  
,  
,  
, N 47, 1, 1-2

info@dns-shop.ge

TP TC (EAЭC)

:



: \_\_\_\_\_

v.6

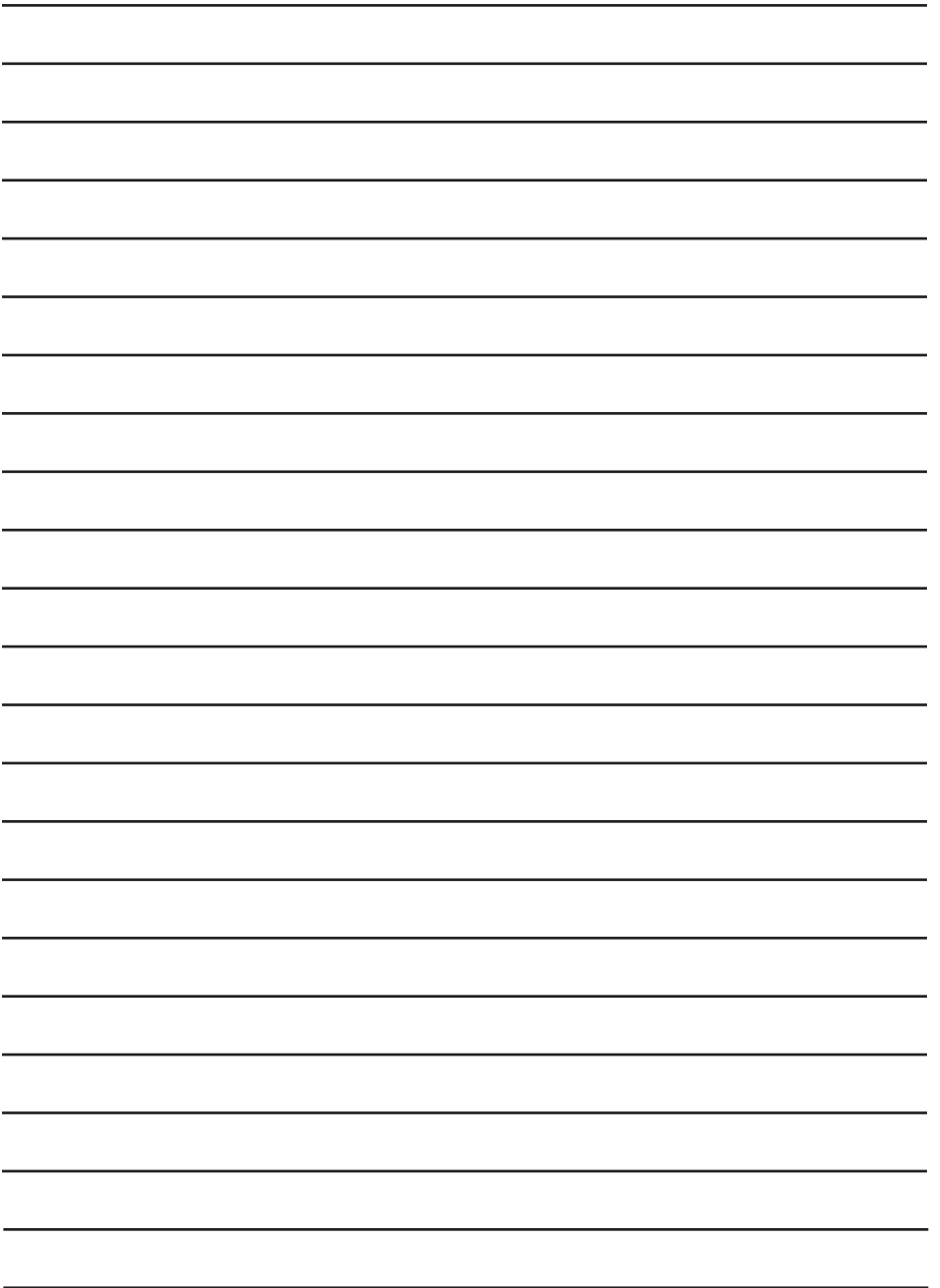

SN/IMEI:

\_\_\_\_\_

\_\_\_\_\_

:

:24

:36

:

( ).

, HANDS-FREE

;

(

),

/



• )

• (

• /

• -

• (

• ),

• :

• )

• (

• ; ) ( )

• /

• ( ) /

• ( CD, DVD, , SIM

• ) ( , Java )



**aceline**