

**aceline**



AMC553H

!

•  
•  
•  
•  
•  
•  
•  
•  
•  
•



•

•

•

•

: AMC553H.

•

: Aceline.

•

: 550

•

: 220–240 , 50

•

: 3

•

: 10.

•

: I.

•

: X.

•

: IPX0.

•

:

•

•

•

•

•

•

•

•

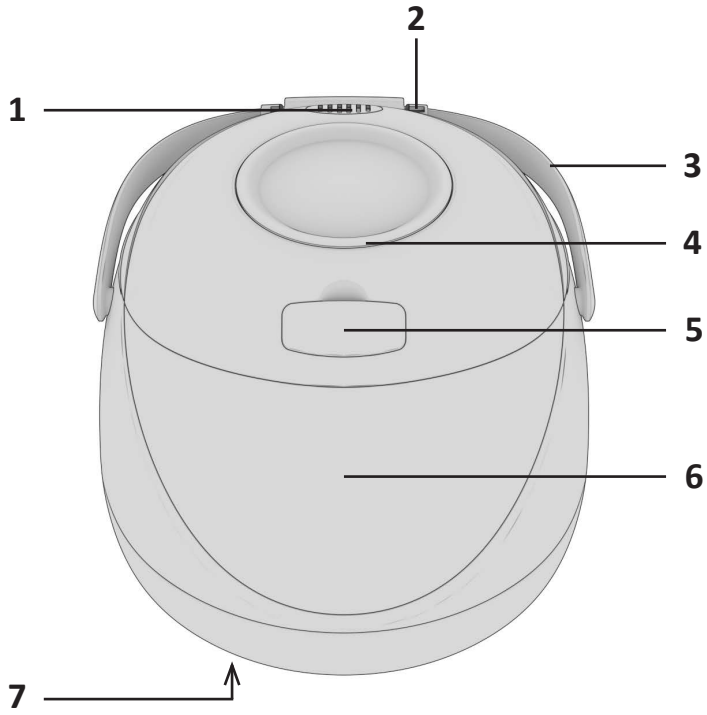

- 1.
- 2.
- 3.
- 4.
- 5.
- 6.
- 7.

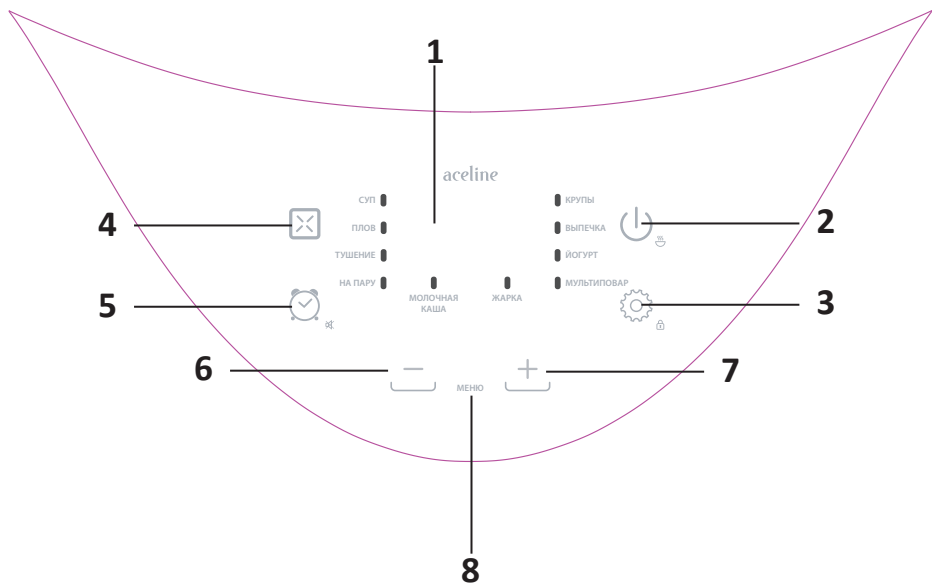

- 1.
- 2.
- 3.
- 4.
- 5.
- 6.
- 7.
- 8.

" / " .  
 " / " .  
 " " .  
 " - " .  
 " + " .  
 " " .

•

•

•

1.

2.

3.

4. "MENU"

5.

6. "START". "Start"

7. "End"

8. 8.

9.

„MENU“ 3

„TIME“ 3

"CANCEL".

)

"START".

1.

2.

"TEMP."

3.

"+" "-"

4.

"START".

1.

2.

"TIME".

"TIME".

3.

"+" "-"

4.

" "

1.

" "

" "

	Время приготовления по умолчанию	Диапазон регулировки времени приготовления			
	1:00	1 – 8 .	-	24	12
	0:30	1 – 4 .	-	24	12
	1:10	1 – 2 .	-	24	12
	1:00	1 – 12 .	-	24	12
/	00:40	1 – 2 .	+	24	12
	01:00	1 – 4 .	-	24	4
	00:20	1 – 2 .	+	-	-
/	08:00	10 – 12 .	-	24	-
/ -			-	24	-
	00:30 100 °C	1 – 15 . 1 – 2 35–160 °C*		24	12

\*MULTICOOK

130°C-

- 
- 
- 

!

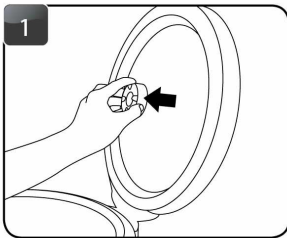

1.

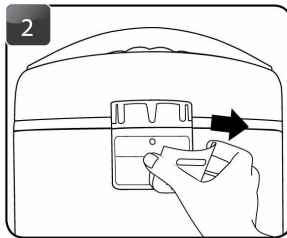

2.

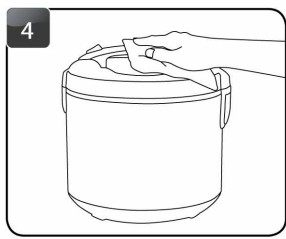
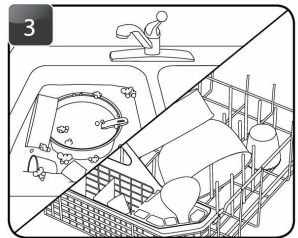

4.

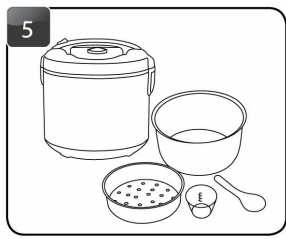

5.

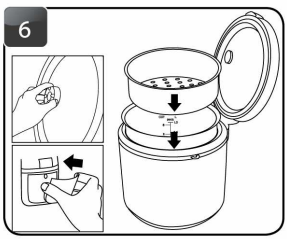

6.

: E1-E4		
	/	
	( )	
	( , )	
( )		
		( , , , )

•  
•  
80%- ( 5°C- 40°C- )  
( )

- 
- 
- 
-

**Manufacturer:** Guangzhou STENT industrial.  
No.2, No.4 Workshop, No.11-1-4, Fuan Industrial Zone, Chonghe Village Committee,  
Leliu Street, Shunde District, Foshan City, Guangdong Province, P.R. China.

: Guangzhou STENT Industrial.

№2, №4, №11-1-4,  
, , , , ,  
, .  
:  
:  
/ 405791674 ,  
,  
, N 47, 1, 1-2

info@dns-shop.ge

TP TC (EAЭC)

:



: \_\_\_\_\_

v.6

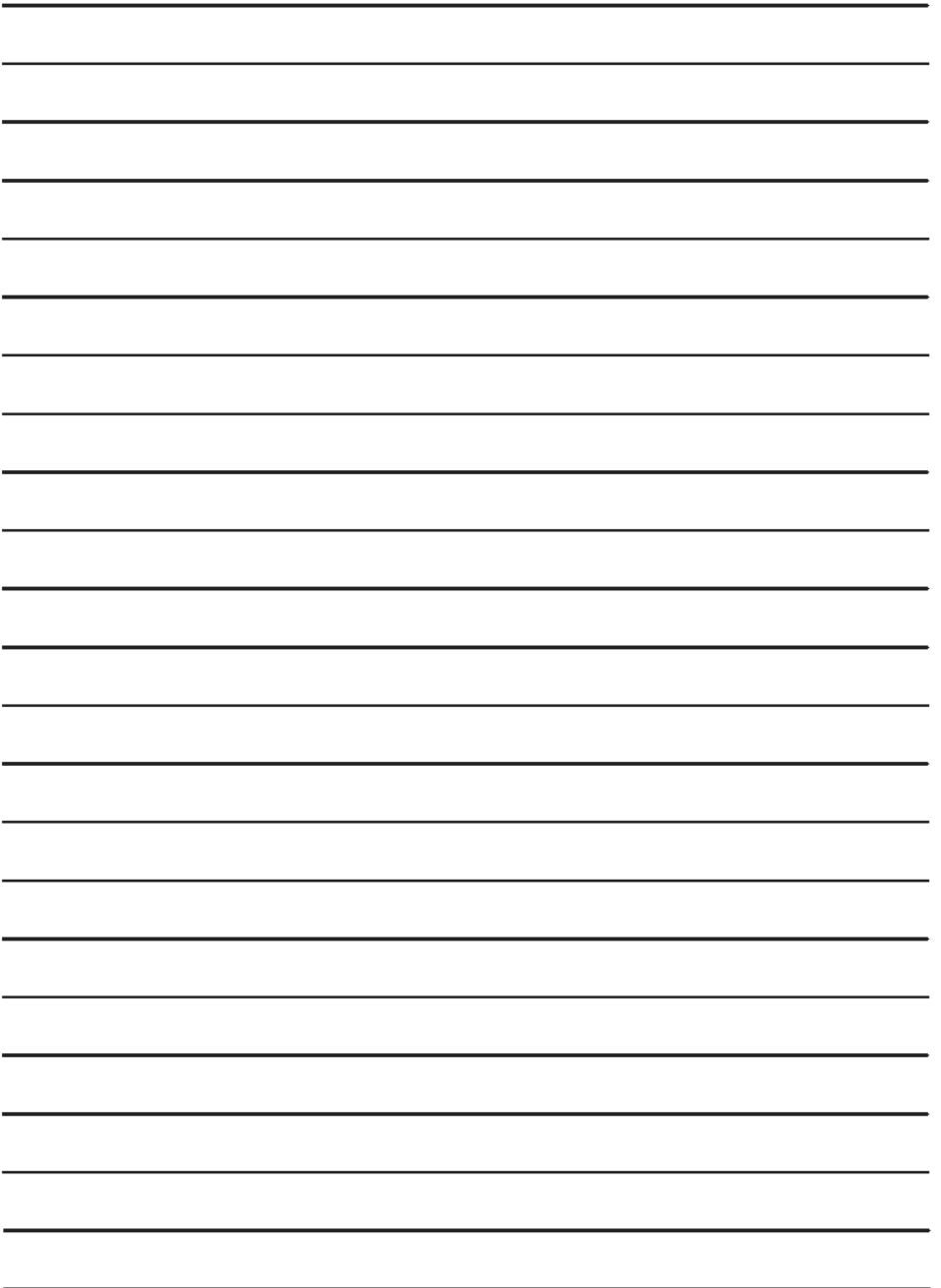

SN/IMEI:

\_\_\_\_\_

\_\_\_\_\_

:

:24

:36

( )

, HANDS-FREE

( )



