

aceline

Aceline
AMC553, AMC865

!

- შეინახეთ მოწყობილობა მშრალ ადგილას.
- არასოდეს შეეხეთ მოწყობილობას სველი ხელებით.

	AMC553	AMC865
	Aceline	
()	550	860
(,)	220–240 , 50	
()	3	5
10		
	I	
	X	

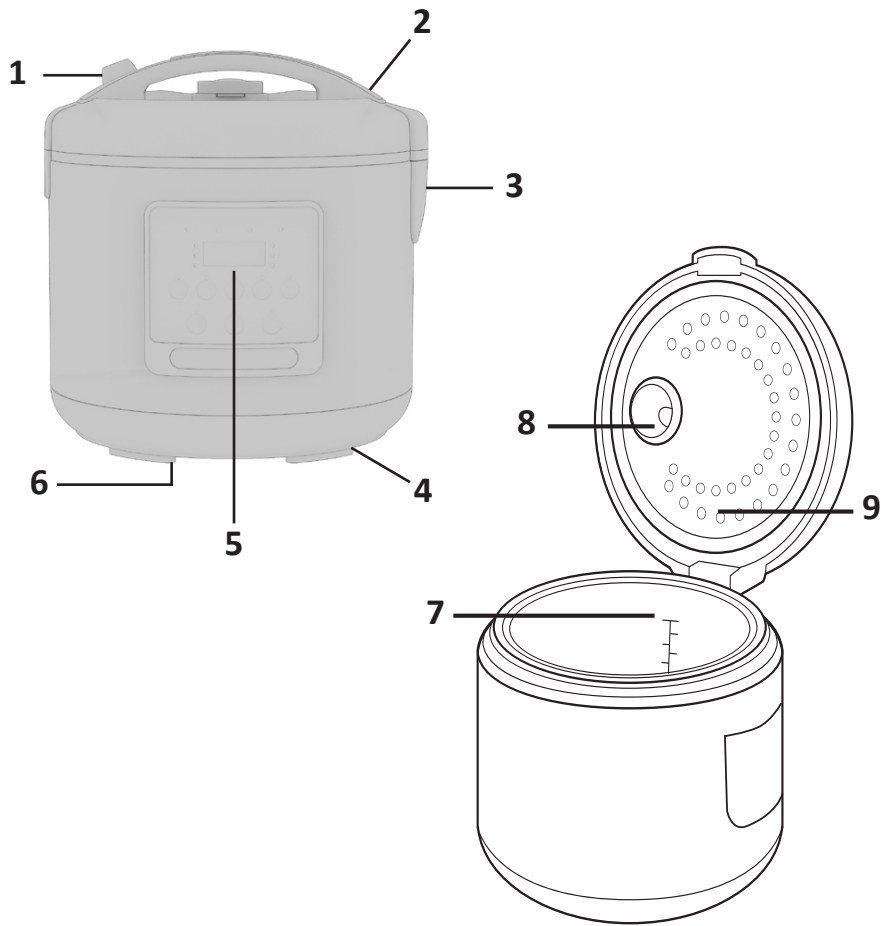

- 1.
- 2.
- 3.

- 4.
- 5.
- 6.
- 7.
- 8.
- 9.



1. .
2. .
3. .
4. " " —
5. " — " + " —
6. " " — / /
7. " " —
8. " " — ,
9. " " —
10. " " —

```

•
•
    .
    ,
    (
    "
    ").
    ,
    ,
    ,
    ,
    ,
    .
1.
    ,
    ,
    ,
    .
2.
    ,
    .
3.
    .
4.
    "MENU"
5.
    ,
6.
    "START".
    "Start"
    .
7.
    "End"
    ,
    .
    ,
    .
    8.
    ,
    "
    "
    .

```

„TIME“ 3

„MENU“ 3

"CANCEL".

"START".

- 1.
2. "TEMP."
3. "+" "-"
4. "START".

- 1.
2. "TIME". "TIME".
3. "+" "-"
4. " "

1. " "
2. " "+" "

	1:00	1 - 8 .	-	24	12
	0:30	1 - 4 .	-	24	12
	1:10	1 - 2 .	-	24	12
	1:00	1 - 12 .	-	24	12
/	00:40	1 - 2 .	+	24	12
	01:00	1 - 4 .	-	24	4
	00:20	1 - 2 .	+	-	-
/	08:00	10 - 12 .	-	24	-
/ -			-	24	-
	00:30 100 °C	1 - 15 . 1 - 2 35-160 °C*		24	12

*MULTICOOK

2 .

130°C-

-
-
-

!

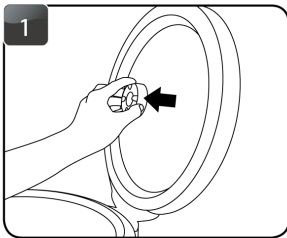

1.

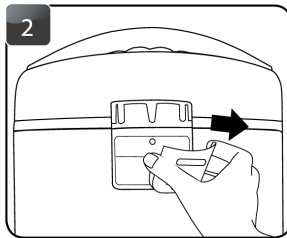

2.

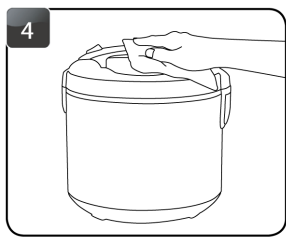
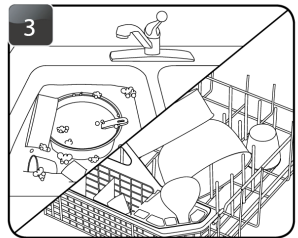

4.

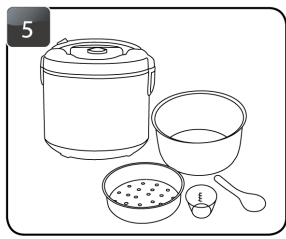

5.

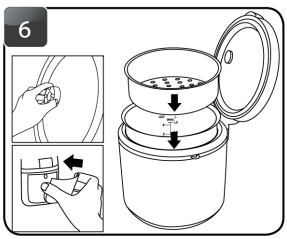

6.

: E1-E4		
	/	
	()	
	(,)	
()		
		(, , ,)

•
•
80%- (5°C- 40°C-)
()
•
•
•
•

Manufacturer: Guangzhou STENT industrial.
No.2, No.4 Workshop, No.11-1-4, Fuan Industrial Zone, Chonghe Village Committee,
Leliu Street, Shunde District, Foshan City, Guangdong Province, P.R. China.

: Guangzhou STENT Industrial.

№2, №4, №11-1-4,
, , , , ,
, .
:
:
/ 405791674 ,
,
, N 47, 1, 1-2

info@dns-shop.ge

TP TC (EAЭC)

:



: _____

v.6

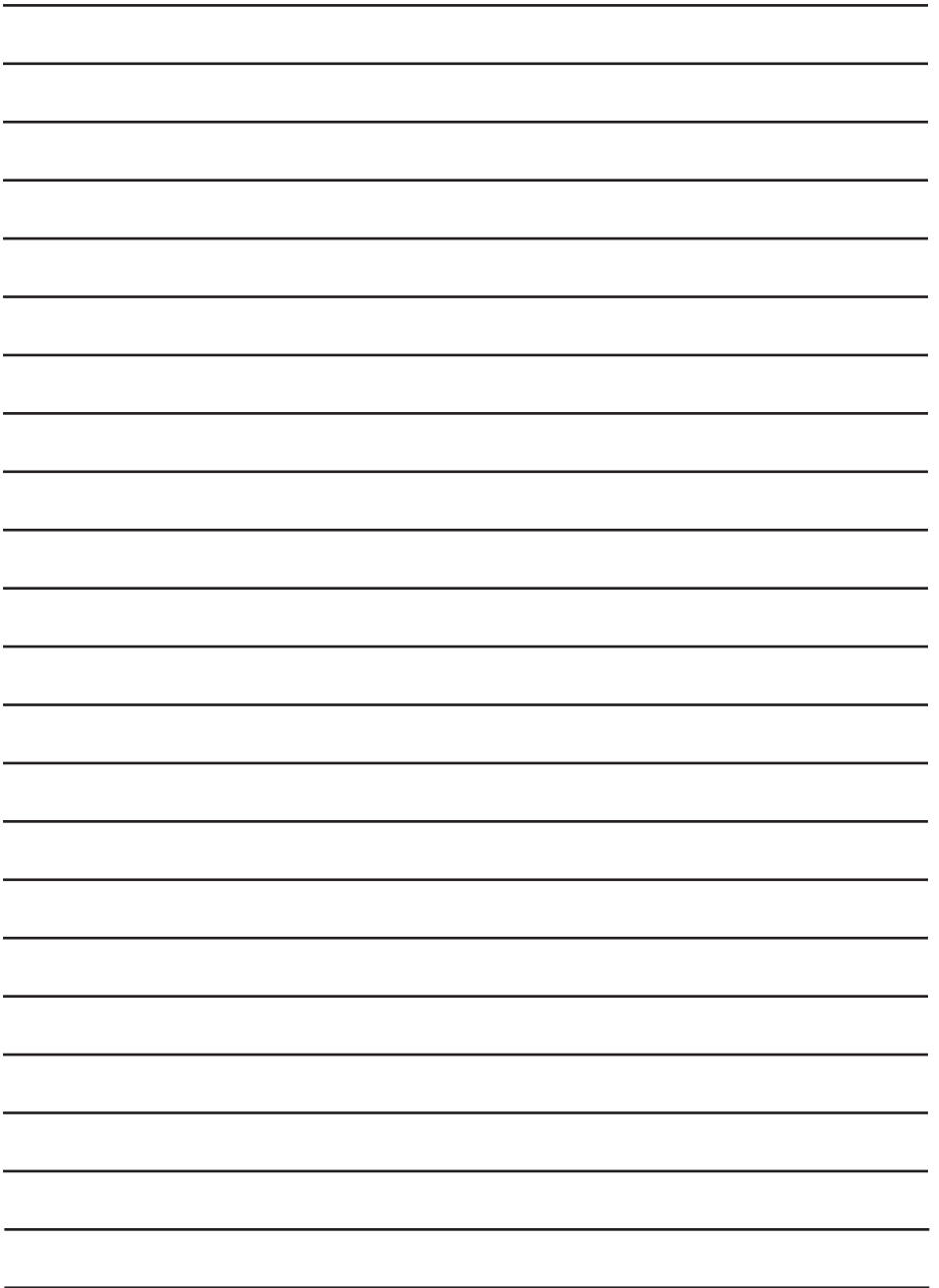

SN/IMEI:

:

:24

:36

()

, HANDS-FREE

(

),



• :
•)
• /
• -
• ()
•)
• (;) ()
• /
•) () /
•) (CD, DVD, , SIM
•) (, Java)



aceline