

RECHARGEABLE BATTERY : Nickel Cadmium

Document Title: RB012080

NC-AA800

Dimensions:

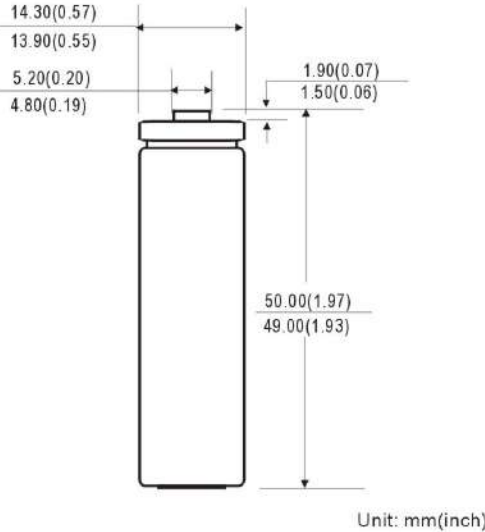

Chemical System	: Nickel Cadmium
Camelion Model	: NC-AA800
Average Weight	: 22.0g
Dimension (Ø x H)	: 14.1 ^{+0.2} x 49.5 ^{+0.5} mm (0.56 ^{+0.01} x 1.95 ^{+0.05} inch)
Nominal Voltage	: 1.2 Volts
Nominal Internal Resistance	: 30m-ohm @ 1kHz
Capacity(160mA constantly discharge to 1.0V at 20±2°C)	
Typical	: 840mAh
Minimum	: 800mAh
Max. Charge Current	: 800mA
Max. Discharge Current	: 2400mA
Relative Humidity	: 65±20%
Jacket	: PVC Label

Fast Charge Characteristics

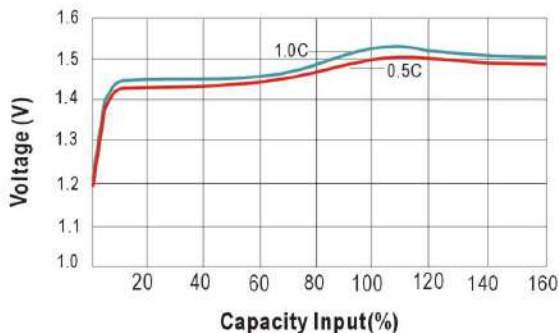

Charging Conditions

Mode	Current	Time	Temperature
Standard	80mA	16.0hrs	0°C~45°C
Quick	240mA	5.0hrs	10°C~45°C
Fast	800mA	1.5hrs*	10°C~45°C
Trickle	26~40mA	Continuously	10°C~35°C

*Can also be controlled with - ΔV or dT/dt system
 $-\Delta V$: 10-20mV
dT/dt : 0.8°C/min(0.5C to 0.9C)
0.8-1.0°C/min(1C)
Timer cut off : 120% nominal capacity
Temp. cut off : 55°C

Continuous Overcharge

80mA maximum current for 28 days
No conspicuous deformation and/or leakage

Operating and Storage Temperatures

Charge at 0.1C : 0°C to 50°C (32°F to 122°F)
Discharge at 0.1C : -20°C to 50°C (-4°F to 122°F)
Storage : -40°C to 50°C (-40°F to 122°F)
(3 Months Max.)
-20°C to 35°C (-4°F to 95°F)
(2 Years Max.)

Service Life

>500 cycles (IEC standard)
Up to 1000 cycles (not less than 60% of nominal at 0.1C Charge/0.2C discharge)

Discharge Characteristics

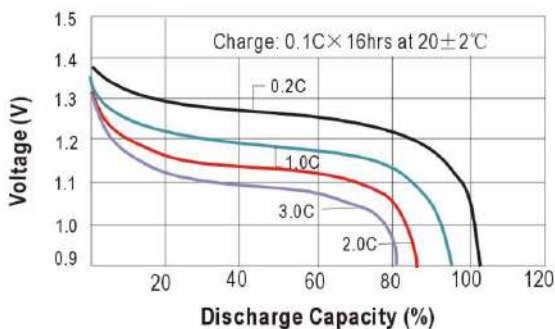

Notice:

This information is subject to change without prior notice and for reference only. It should not be used as a basis for a product guarantee or warranty. For additional information, please consult your nearest Camelion Sales Office or Distributor or visit our website at: www.camelionbattery.com.