



MARS PRO 150

GAMING DESK

FOLLOWED BY COUGAR MARS, COUGAR MARS PRO 150 STANDS ON THE SHOULDERS OF GIANTS. NOT ONLY MARS PRO 150 RETAINS FEATURES OF MARS BUT EVOLVES WITH MUCH MORE HANDY FUNCTIONS, SUCH AS A USB-C PORT FOR DATA TRANSFERS AND HDMI MONITOR EXTENSION. IT'S NOT JUST A GAMING DESK, IT'S THE DESK HOW IT MAKES YOUR DREAM COME TRUE.

ADVANCED AND HIGH-SPEED LINKS

With a control unit, you can easily extend USB-C, USB 3.0, and audio devices conveniently. By HDMI extension through Type-c connector, you can have the extra monitor to maximize your work. It is extremely helpful for streamers or content creators.

ENORMOUS AND ERGONOMIC GAMING SPACE

The spacious gaming surface up to 150cm width with carbon fiber texture brings you plenty of space for your gaming monitors, gaming keyboards, and other gaming gears. Highly ergonomic designs like curved edges and rounded corners give you a better and more comfortable gaming experience.

DUAL-SIDED RGB LIGHTING EFFECTS

To increase more immersive feeling in your gaming atmosphere, Mars Pro 150 provides various RGB lighting effects. It is also compatible with motherboards' 5V connection with Asus Aura Sync, Gigabyte RGB Fusion, MSI Mystic Light Sync, and ASRock Polychrome Sync for system-wide lighting synchronization.

HIGH-STRENGTH WELDED STEEL FRAME FOR MAXIMUM STABILITY

COUGAR Mars Pro 150 is made of high-strength steel frame for ultimate stability. The height of the gaming desk is manually adjustable between three levels (750/800/850mm) for the most comfortable position.

ENGLISH

- HDMI monitor extension via Type-C cable, USB-C ports, two USB 3.0 ports pass-through connection, 3.5mm audio jack.
- Ergonomic curved edges design and rounded corners.
- Dual side wing RGB backlight effects.
- Support for 5V RGB motherboard connections (ASUS, ASRock, Gigabyte or MSI).
- Desktop height adjustment (75/80/85CM).
- Carbon fiber texture design.
- High-strength welded steel frame for maximum stability.

ESPAÑOL

- Extensión de monitor HDMI mediante cable tipo C, puertos USB-C, conexión de paso de dos puertos USB 3.0, conector de audio de 3,5 mm.
- Diseño ergonómico de bordes curvos y esquinas redondeadas.
- Wing Ala lateral doble RGB efectos de retroiluminación.
- Soporte para conexiones de placa madre de 5V RGB (ASUS, ASRock, Gigabyte o MSI).
- Ajuste de altura de la mesa (75/80 / 85CM).
- Diseño de textura de fibra de carbono.
- Frame Bastidor de acero soldado de alta resistencia para una máxima estabilidad.

ITALIANO

- Estensione monitor HDMI tramite cavo Type-C, porte USB-C, connessione pass-through per due porte USB 3.0, jack audio da 3,5 mm.
- Design ergonomico dei bordi curvi e angoli arrotondati.
- Ala laterale doppia RGB e fetti di retroilluminazione.
- Supporto per connessioni della scheda madre RGB 5V (ASUS, ASRock, Gigabyte o MSI).
- Regolazione altezza del frontallo (75/80 / 85CM).
- Design della trama in fibra di carbonio.
- Telaio in acciaio saldato ad alta resistenza per la massima stabilità.

PORTUGUÊS

- Extensão de monitor HDMI via cabo Tipo C, portas USB-C, conector de passagem de duas portas USB 3.0, conector de áudio de 3,5 mm.
- Edges Design de bordas curvas ergonômicas e cantos arredondados.
- Sídeas asa lateral dupla RGB efeitos de luz de fundo.
- Supporte para conexões de placa-mãe de 5V RGB (ASUS, ASRock, Gigabyte ou MSI).
- Ajuste de altura de desktop (75/80 / 85CM).
- Design/Design de textura de fibra de carbono.
- Estrutura de aço soldado de alta resistência para máxima estabilidade.

SPECIFICATIONS

Product Name	COUGAR MARS Pro 150 Gaming Desk
Model No.	CGR-MARS PRO 150
I/O Panel	LED Switch / USB-C x1 / USB 3.0 x2 / Audio Jack x2 / HDMI Monitor Extension Via Type-c cable
Desk Dimension	153.3 (W) x 77.1 (D) mm / 60.4 (W) x 30.4 (D) inch
Desk Height	Three Height Options : 75 / 80 / 85 (H) cm ; 29.5 / 31.5 / 33.5 (H) inch

ДАТА ИЗГОТОВЛЕНИЯ ПРОДУКЦИИ

год и месяц изготовления продукции указаны в серийном номере продукта. (существует 2 способа определения даты изготовления, оба способа описаны ниже)
 После S/N: первые две цифры означают год, вторые две – месяц изготовления.
 Например, S/N: H170200001 означает, что товар был произведен в феврале 2017 года.
 После S/N: если указаны буквы, то две буквы представляют цифры из таблицы ниже, и означают год, следующие две цифры – месяц изготовления.
 Например, S/N: DAG02REV000001 означает, что товар был произведен в феврале 2017 года.

A	B	C	D	E	F	G	H	I	J
1	2	3	4	5	6	7	8	9	0

БЪЛГАРИЯ

• Подробни инструкции за употреба изтеглете от: <https://cougargaming.com/bg>



България QR код

ACCESSORY KIT

CTN:2/2				CTN:1/2			
A				C			
1			x8	6			x8
2			x4	7			x4
3			x1	8			x1
B				D			
4			x44	9			x1
Spare parts 1 / 4 x 2				10			x4
5			x4	11			x1
				12	Exclusive Monitor Extension Cable		x1

1 Assemble the base legs (A, B) using screws (1) and spacers (2).

2 Attach the side rails (C, D) to the base legs using screws (1) and spacers (2).

3 Attach the front and back rails (E, F) to the side rails using screws (1) and spacers (2).

4 Attach the support brackets (G, H) to the front and back rails using screws (4).

5 Attach the front and back feet (I, J) to the support brackets using screws (4).

6 Attach the side feet (K, L) to the side rails using screws (4).

7 Attach the front and back feet (M, N) to the front and back rails using screws (1).

8 Attach the top plate (O) to the front and back rails using screws (4). **Warning:** Position and do not tighten the screws.

9 Attach the side plates (P, Q) to the side rails using screws (4).

10 Attach the front and back plates (R, S) to the front and back rails using screws (4).

11 Attach the control unit (T) to the front plate using 16 screws.

12 Attach the LED strip (U) to the front plate using screws (7).

13 Attach the monitor extension cable (V) to the control unit using screws (6). **Warning:** When the control stands are uneven on the gaming desk, they will be automatically corrected when locking the screws. To avoid the screw bosses are damaged, please do not lock the screws too tight.

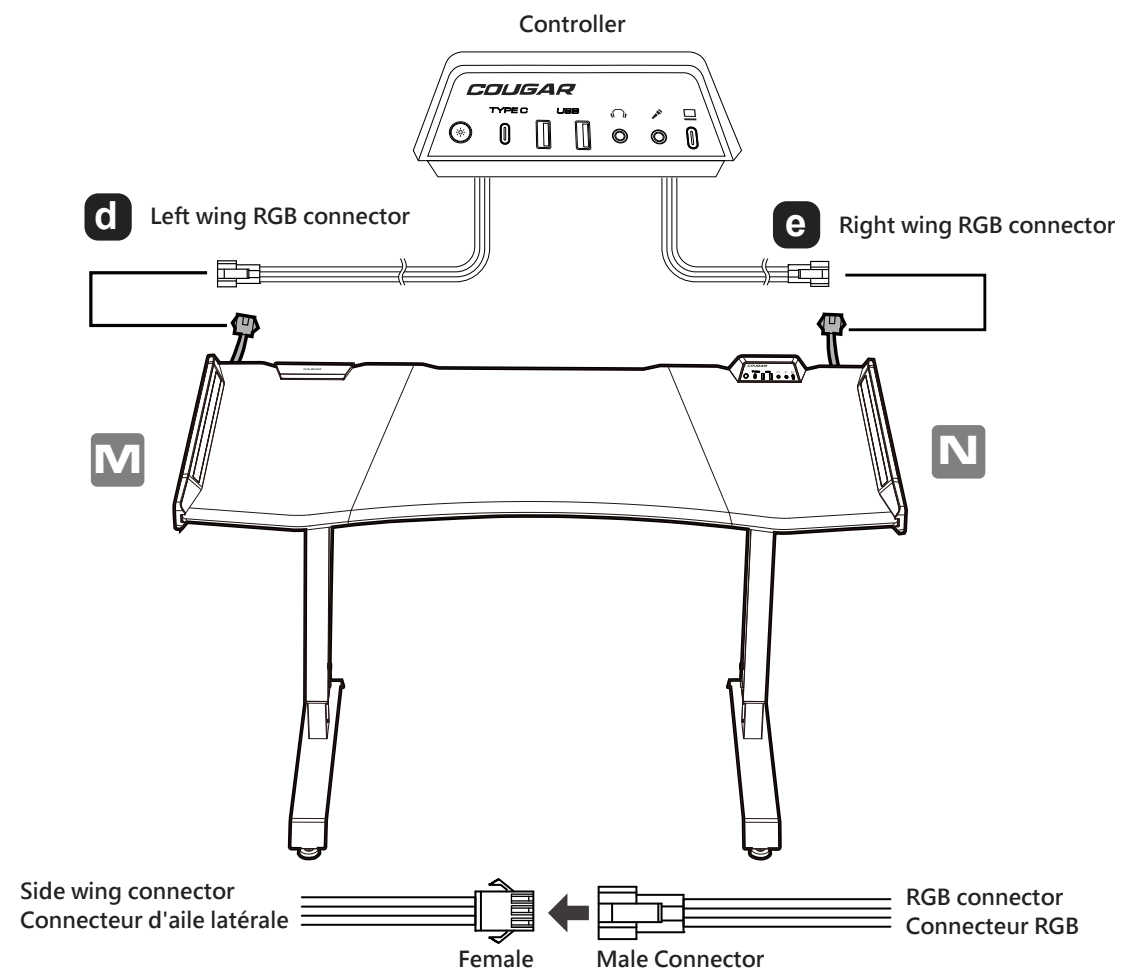
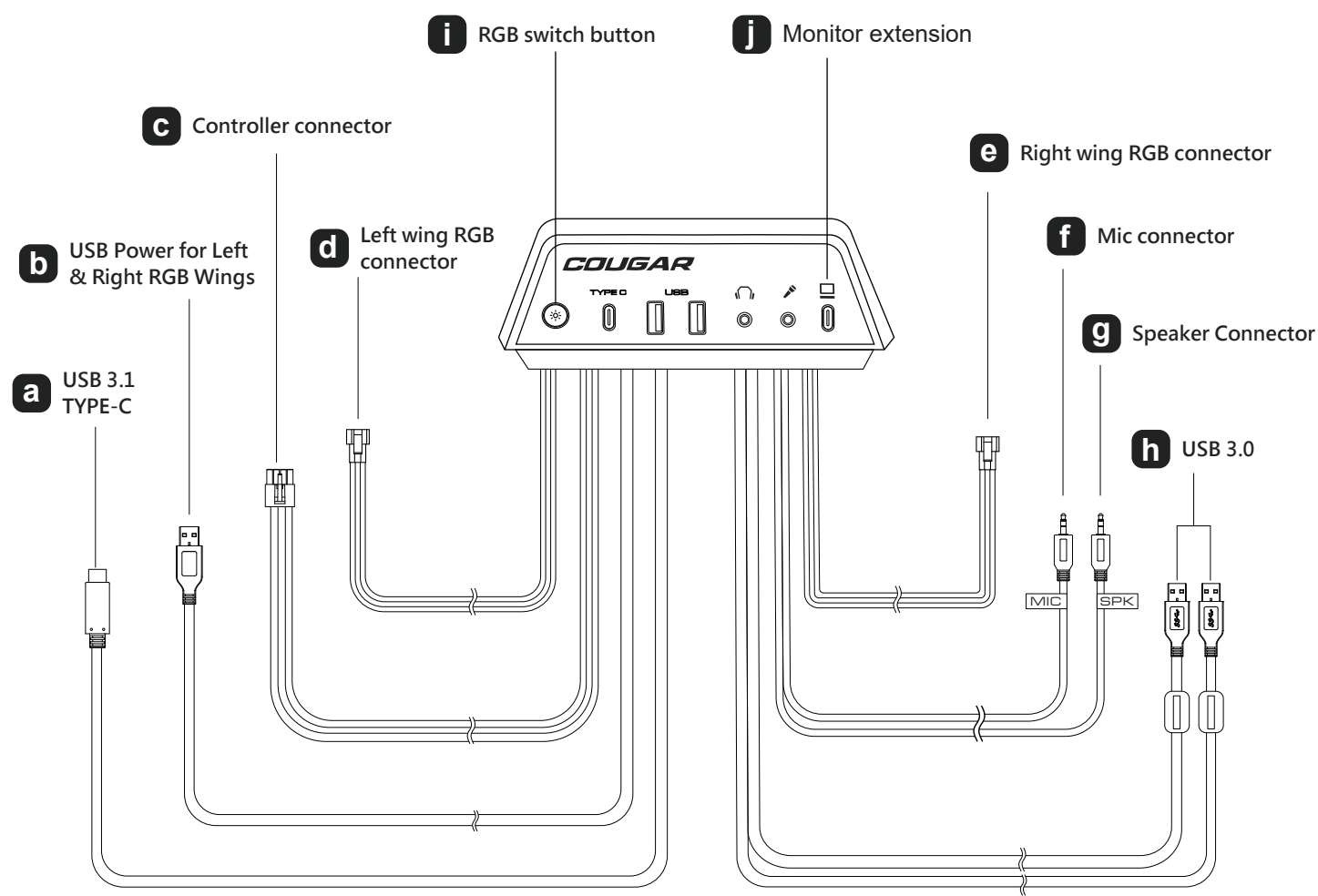

Controller connector to PC

STEP .1

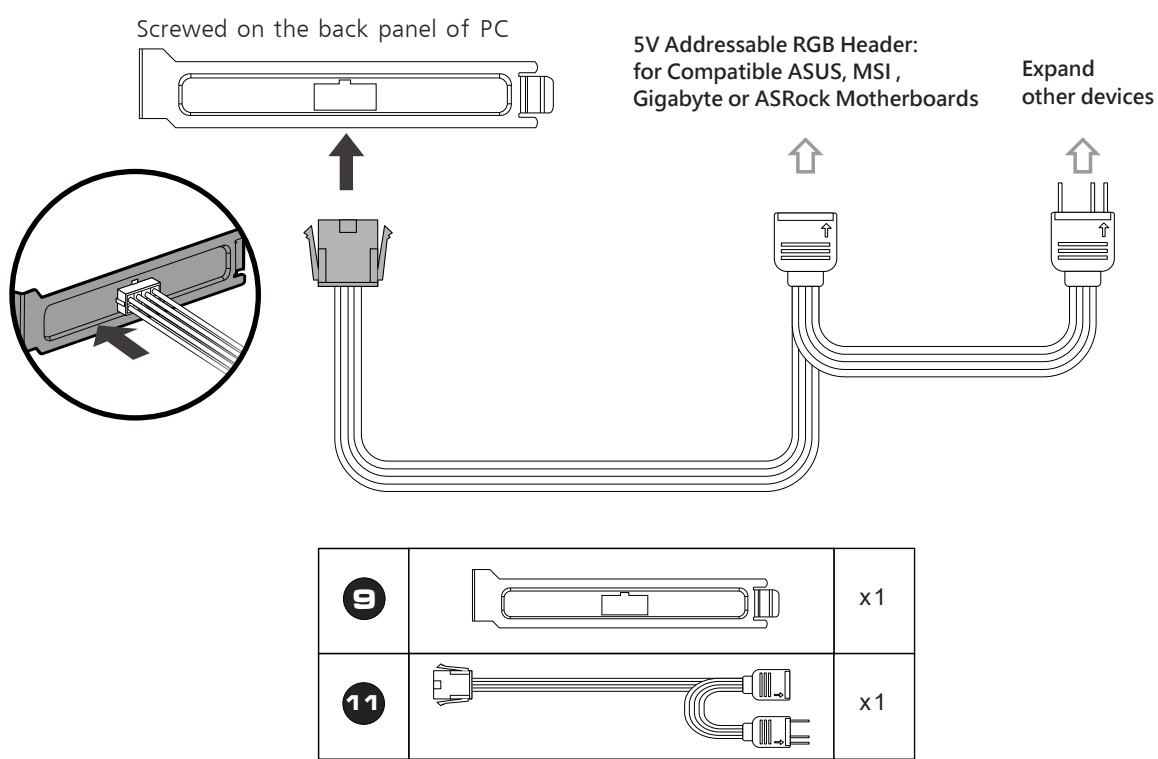

STEP .2

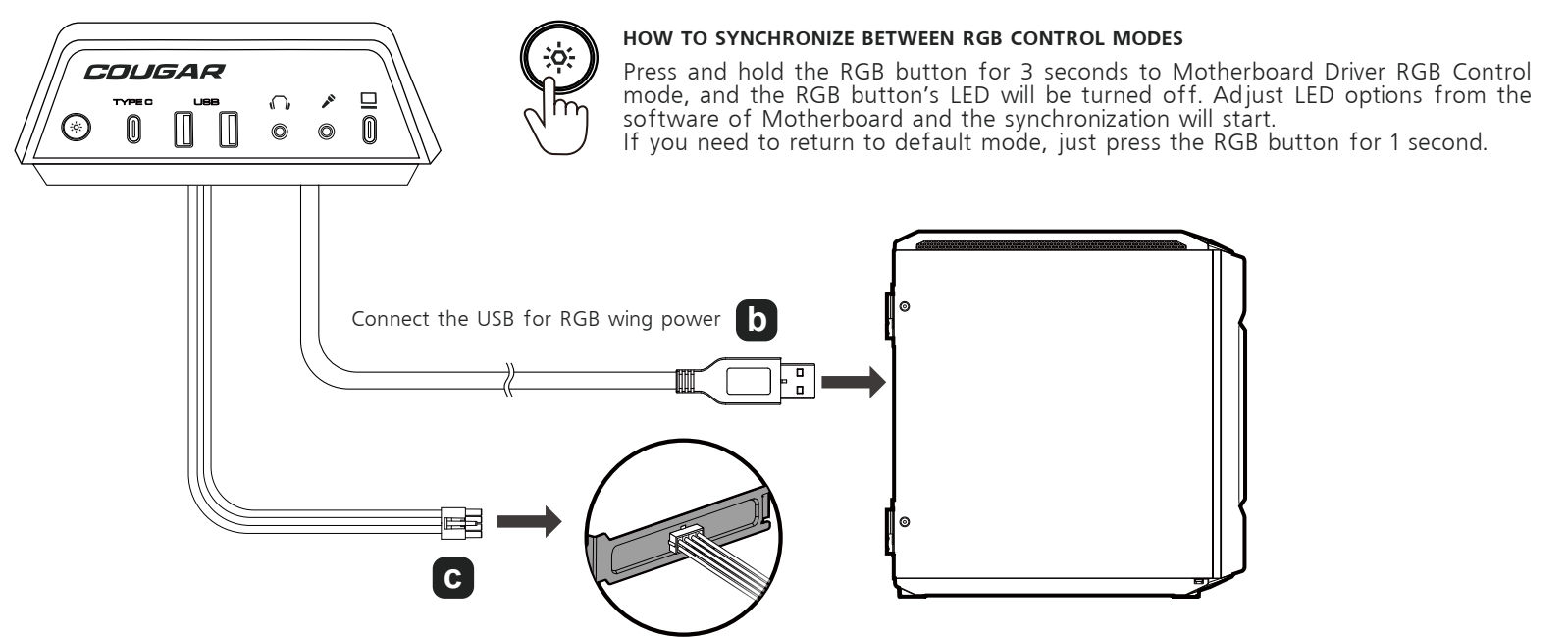

USB 3.0 Extension to PC

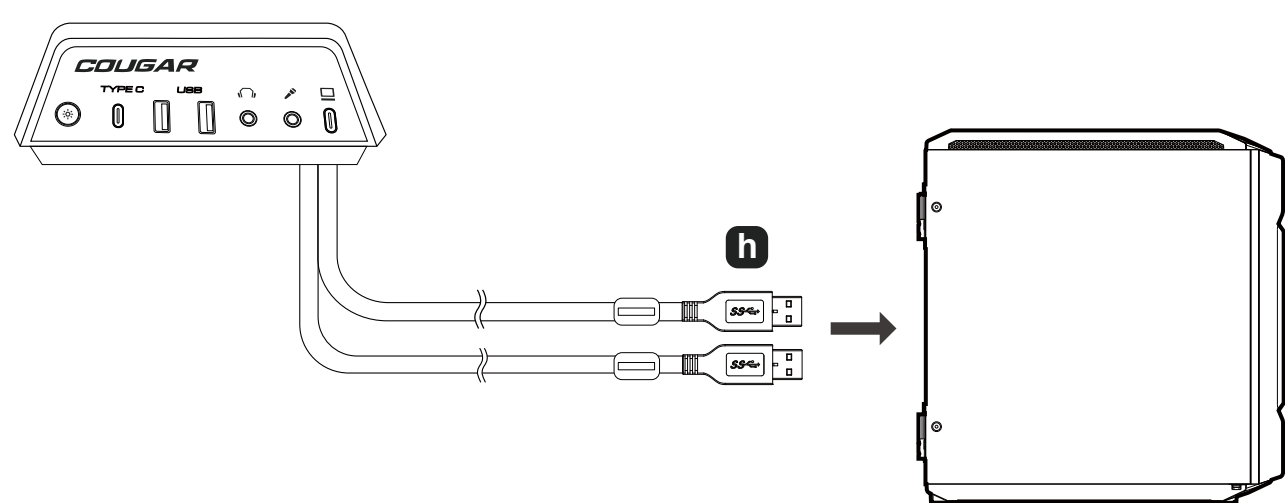

USB 3.1 TYPE-C Extension to PC

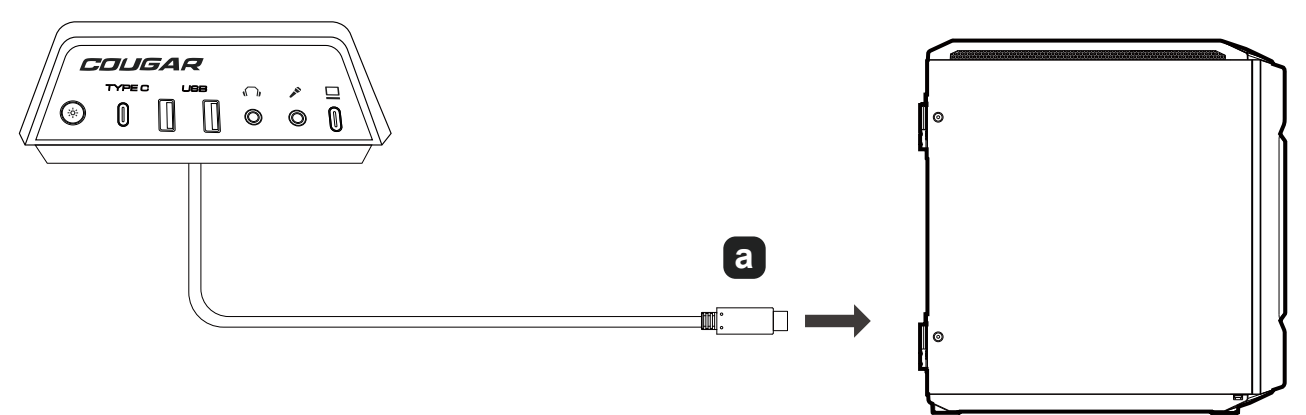

Connecting Monitor Extension Cable to Notebook

STEP .1

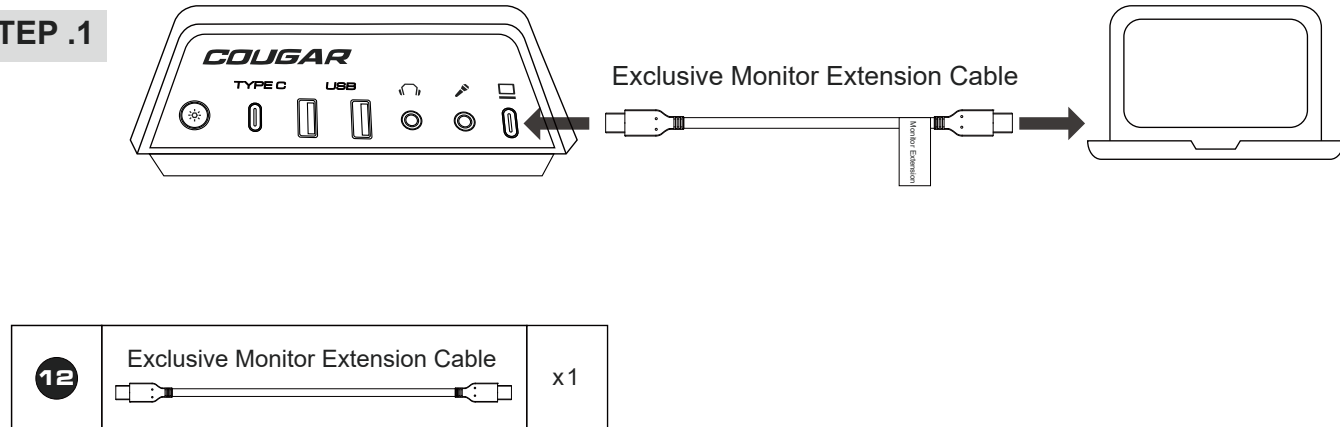

STEP .2

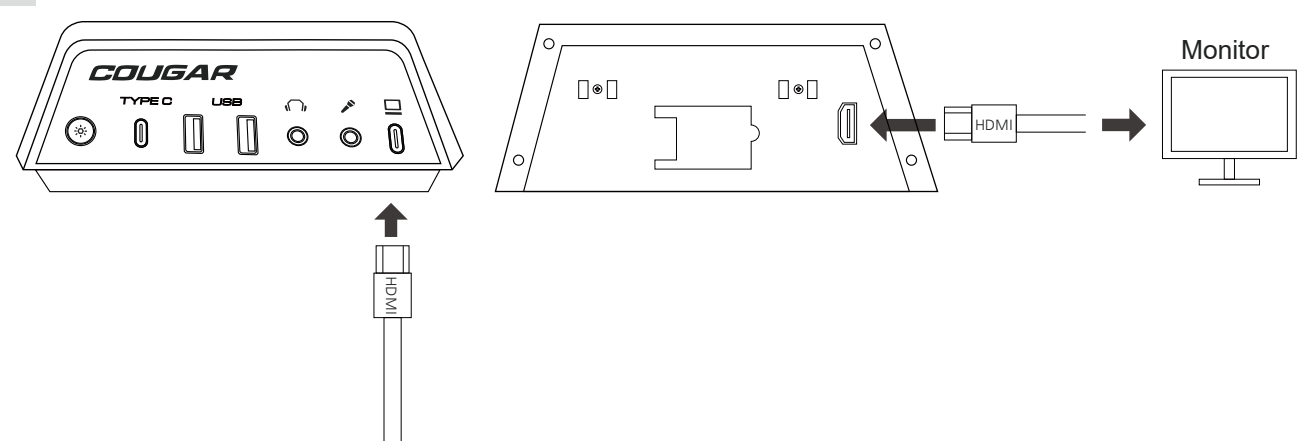

Audio Extension to PC

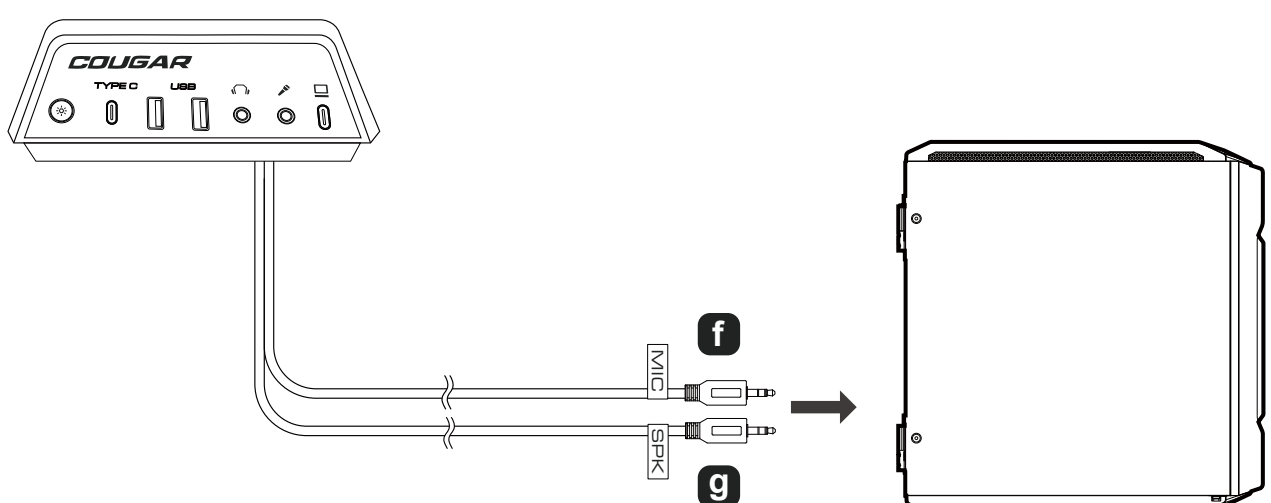

GLOBAL WARRANTY POLICY

WARRANTY PERIODS OF COUGAR GAMING DEVICES
 Product : COUGAR MARS PRO 150 GAMING DESK
 Warranty : 1 Year
 This warranty gives you specific legal rights. You may also have other rights granted under local law. These rights may vary.

WARRANTY AGREEMENT
 If the product has defects in material or manufacture, COUGAR will provide product repair and replacement service within the warranty period.
 Our warranty service is based on the date of the invoice or warranty card.

CONDITIONS WHERE FREE MAINTENANCE IS NOT PROVIDED
 Any fault or damage caused by natural disasters (including storm, fire, flood, thunder, earthquake, etc).
 Any fault or damage caused by accidental factors and man-made reasons (including hit, scrape, crash, moving, compression, stain, corrosion, riot, misuse, malicious damage, etc).
 Use in an improper operating environment (including high temperature, high humidity, water inflow, etc).
 Inability to provide the product warranty card, purchase receipt or invoice to prove the product is still within the warranty period and the shipping date of the product is out of warranty.
 The warranty card has been altered or its number is hard to identify.
 The warranty period has expired.
 Any fault or damage caused by non-compliance with regulations stated on the user manual or improper, rough and careless treatment.
 Any fault or damage caused by use of parts not certified by COUGAR original manufacturer.
 The problem is caused by improper repair or adjustment by the buyer or any manufacturer without authorization from COUGAR.
 The product is not acquired from an authorized distributor of the company or is acquired from illicit sources.
 Paper carton, instruction and other accessories are not warranted.

DISCLAIMERS
 COUGAR products should not be used as critical components in life support devices.
 COUGAR is not liable for any damage of life and limb or damage or loss of property caused by or during COUGAR products' use as or with medical equipment, military equipment, traffic equipment and disaster prevention systems.
 COUGAR's warranty liability is limited to repair or replacement. The decision on whether to repair or replace belongs exclusively to COUGAR.

COUGAR is, to the extent not prohibited by law, not liable for any damages; expenses; lost data, revenues, savings or profits; or any incidental or consequential damages happened while the use of a defective product from COUGAR or due to its use.

WARNING

- Please wear protective gloves when assembling the Desk. It is your own responsibility to use appropriate protection to prevent any physical damage.
- Do not use abrasive products or scrub energetically when cleaning. Please stick to gentle products suitable for delicate materials.
- All parts should be checked monthly to confirm their integrity and to make sure that the screws are not loose.
- If any part of the product is or appears to be damaged, missing or loose, please contact the local distributor and do not use the product. WARNING

LEGAL NOTICES

This manual was created by Compucase Enterprise and may not be completely or partially copied, passed on, distributed or stored without written consent by Compucase Enterprise. COUGAR® is a registered brand of Compucase Enterprise Other product and company names mentioned in this documentation may be brands or trademarks of their respective owners. Compucase Enterprise reserves the right to make changes concerning the contents of the manual and the technical data of the product without previous announcement.

MANUFACTURER CONTACT

Compucase Enterprise Co.,Ltd. COUGAR USA Technical Service
 No. 225, Lane 54, An Ho Road Sec. 2 Tainan, Taiwan, R.O.C. Tel: (833) 256-3778
 Tel:+886-6-356-0606 Mail: rma@compucaseusa.com
 Service email : <https://cougargaming.com/support/contact/upload/>
 Compucase Enterprise Co.,Ltd. All rights reserved. Made in China



www.cougargaming.com
[facebook.com/cougargaming](https://www.facebook.com/cougargaming)
[youtube.com/user/COUGARGLOBAL](https://www.youtube.com/user/COUGARGLOBAL)