

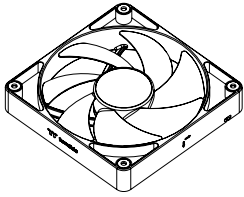

Parts List



A x 2



B x 8



C x 8



D x 2

Installation Guide

1

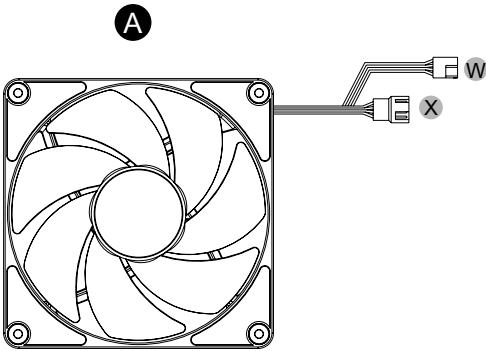

2

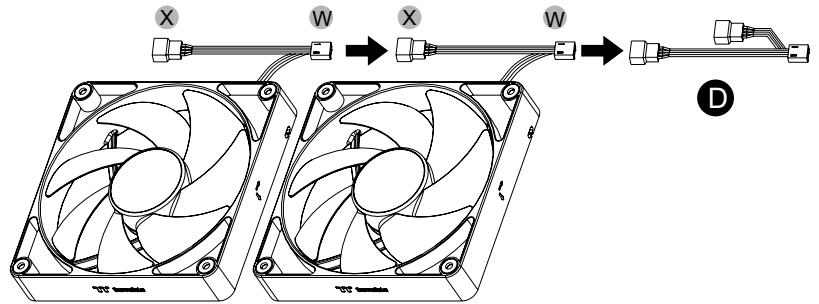

3

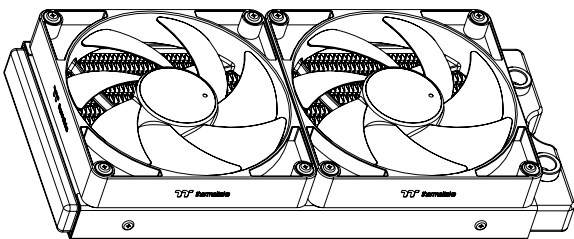

4

